

HIGH-PRESSURE

COOLING-LUBRICANT-

SUPPLY SYSTEMS

IN STAINLESS STEEL



**Type0**

1/8" System  
inside Ø 3,2 mm

**Type1**

1/4" System  
inside Ø 5,8 mm

**Type2**

1/2" System  
inside Ø 11 mm

**Type3**

3/4" System  
inside Ø 19 mm

INDIVIDUAL & FLEXIBLE

**Hirt**<sup>®</sup>  
**LINE**



## The Original Modular Hose System | Hirt-Line®

Our joint hose system can be extended as required, is stainless and offers a long service life. The individual parts are precision-manufactured and insensitive to heat and chemical substances. Can be easily screwed together, adjusted, lengthened and shortened by hand. Neither coolant pressure nor machine vibrations can change the position.

Pressure resistant over 100 bar. Can be used on machine tools and production plants, mainly on turning machines, milling machines, grinding machines, sawing machines and filling plants. Suitable for emulsions, cooling and cutting oils, chemical substances and for air cooling.

### Properties:

- Jet precisely adjustable and fixable (screwable)
- Resistant to high temperatures, chemical substances, chips, pressure and vibrations
- Corrosion-resistant material 1.4305 V2A (on request in V4A)
- Wear resistant
- Pressure stable above 100 bar
- Application range -30°C to +60°C
- Optional ES-System up to +300°C (available on request)
- 4 system sizes, all among each other compatible
- Long service life
- Can be used directly on the tool (tool connections)
- Versatile in combination
- Sophisticated and effective assortment
- Applicable in the food industry
- Connection elements for each machine
- Basic sets in every system





## Longer tool lifespans and less machine downtime for manufacturing systems

Although plastic joint hoses are very flexible coolant lines, they only offer the required operational reliability to a limited extent. Standard joint hoses are often misaligned by vibrations or chips and the coolant no longer gets to where it is

needed. Machine downtimes and even tool damage are expensive and can be avoided. Increase your productivity with our manufacturer-independent Hirt-Line® coolant and lubricant line system for turning, milling and grinding machines.

### **MADE IN SWITZERLAND is the quality promise of Hirt-Line®**

We are committed to this through our own flexible production and high quality standards. Whether series production of

standard products or custom-made special solutions - we are here for you!





## 4 System sizes

**Type0** | 1/8" | passage Ø 3,2 mm | thread M8 x 0,75

**Type1** | 1/4" | passage Ø 5,8 mm | thread M14 x 1,0

**Type2** | 1/2" | passage Ø 11,0 mm | thread M24 x 1,25

**Type3** | 3/4" | passage Ø 19,0 mm | thread M34 x 1,25

**All compatible with each other!**



## Machine adapter

In addition to the standard pipe thread G1/8", G1/4", G3/8", G1/2", G3/4", G1" as well as metric threads M5 x 0,8 over M14 x 1,0 to M20 x 1,5, we also offer conical threads and ball head adapters with the dimensions of Ø10 mm, Ø12 mm, Ø14 mm, Ø15 mm, to various special adapters.

On request you will receive your special connection adapter!



## Basic elements

3,2 mm, 5,8 mm, 11,0 mm and 19,0 mm inside diameter measure the basic elements of the Hirt-Line system. The variety of different standard lengths of 9.3 mm over 100 mm up to 1000 mm make a precise setting up and fixing the cooling jet to the desired place possible. And so make for an effective and easy customization. Other lengths on custom production possible.





## Elbows

The Hirt-Line® system offers many different elbow elements in every system size, whether type 0, type 1, type 2, or type 3 we have the right e.g. elbows 90°, multiple connections, T- and Y-pieces. Due to the large selection, we ensure the greatest possible flexibility of the system. Special fittings on request!



## Nozzles

The nozzles made of a material 1.4305 (V2A) are insensitive to heat and are available from Ø0.5 mm, over Ø10.0 mm up to Ø19.0 mm passage. Our numerous flat nozzles with different slot widths leave nothing to be desired; ideally suited for washing or cooling as well as flat and cylindrical grinding. There are also some special nozzles, either with several holes or mini-slots. Optimized for perfect cooling!



## Accessories

The Hirt-Line® accessories consist of our own products such as quick couplings, knurled nuts or locking caps, plus reductions to combine the individual systems with each other. We also offer suitable external articles, e.g. ball valves and open-end wrenches. With this range you ensure an optimal and stable coolant supply for the future, especially for individual applications.



All items available in different sizes  
and in every system.  
(Example image Type2 System)

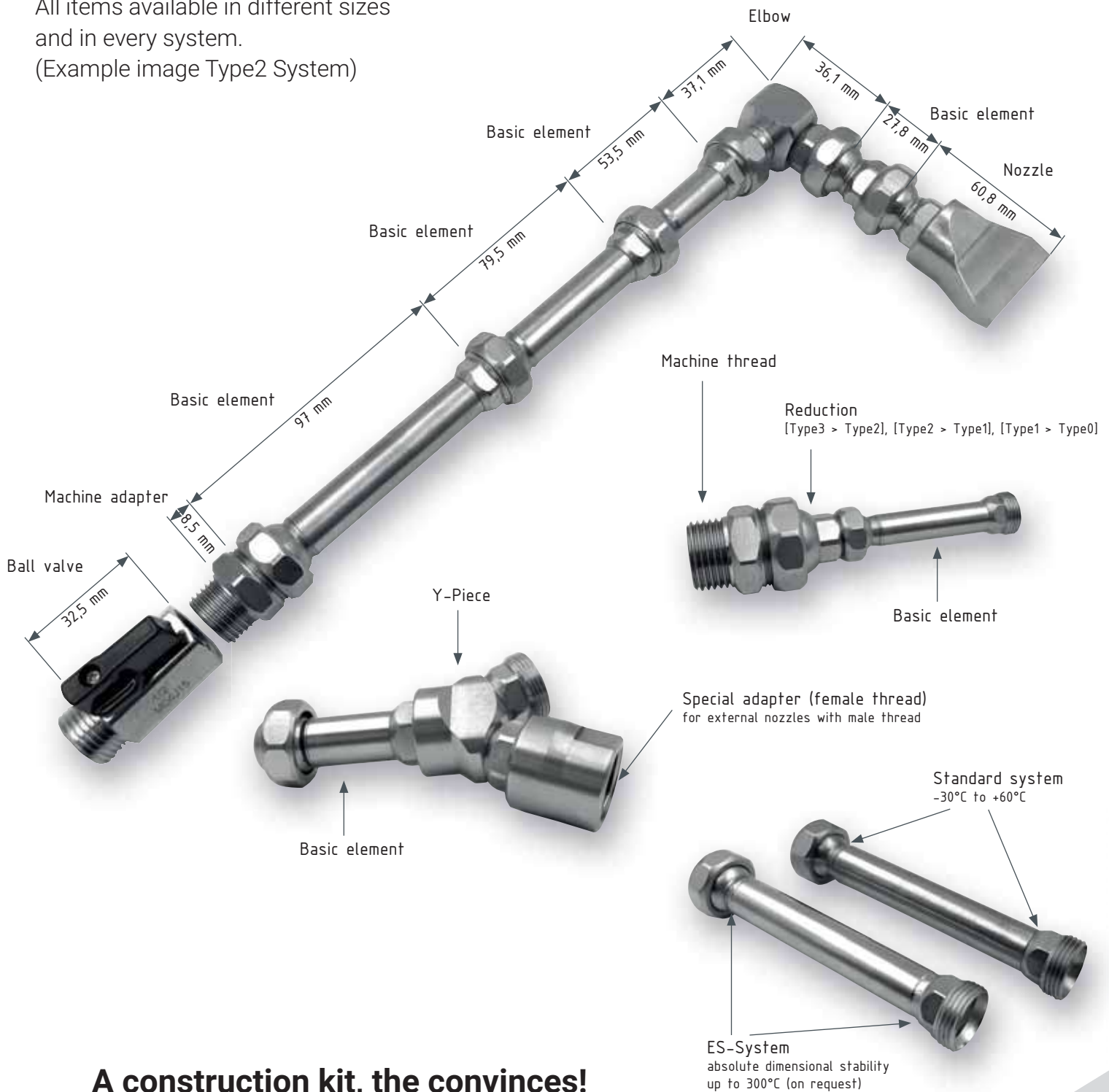

## A construction kit, the convinces!

The Hirt-Line® system can be the basis for successful production. The basis for the system in turn are its individual components. Hirt-Line® makes all components and their data available here individually in order to give customers the opportunity to go their own way in the design and implementation of their systems. Hirt-Line® has compiled all its elements in a catalogue for quick and easy ordering.

## PRODUCT OVERVIEW

Type0 [1/8"]



The latest Type0 system is quick to install, easy to set up for the right tool and includes a variety of suitable nozzles from Ø0.5 mm to Ø3.0 mm up to nozzles with several outlets. A wide range of machine adapters from M5x0.8 over M10x1.5 up to ball adapters with Ø10.0 mm and of course also different basic and angle elements provide the user with the necessary flexibility and variability in the processing of their products.

**TECHNICAL SPECIFICATIONS:**

- Size Type0 (1/8")
- Passage  $\varnothing 3,2$  mm
- Pressure resistant up to 80 bar
- Application range  $-30^{\circ}\text{C}$  to  $+60^{\circ}\text{C}$
- Optional ES-System up to  $+300^{\circ}\text{C}$  (available on request)
- Thread (Elements) M8x0,75
- Material 1.4305 (V2A)

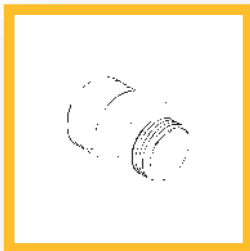
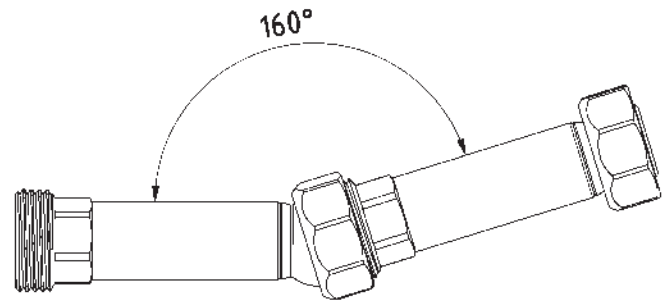
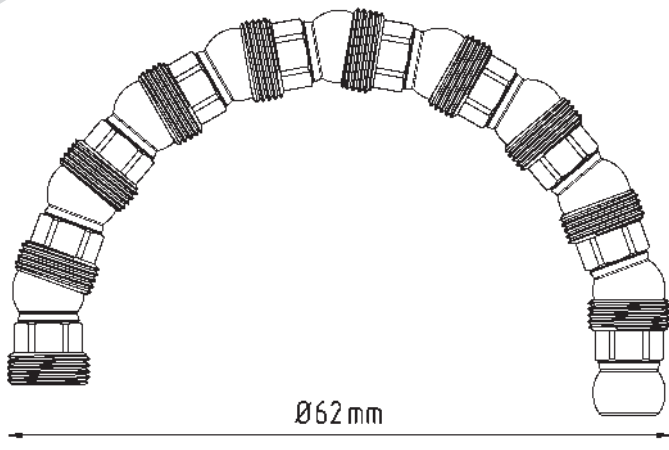

MACHINE ADAPTER



BASIC ELEMENTS



NOZZLES



ELBOWS



ACCESSORIES



BASIC SET Type0



# Type0 [1/8" System]

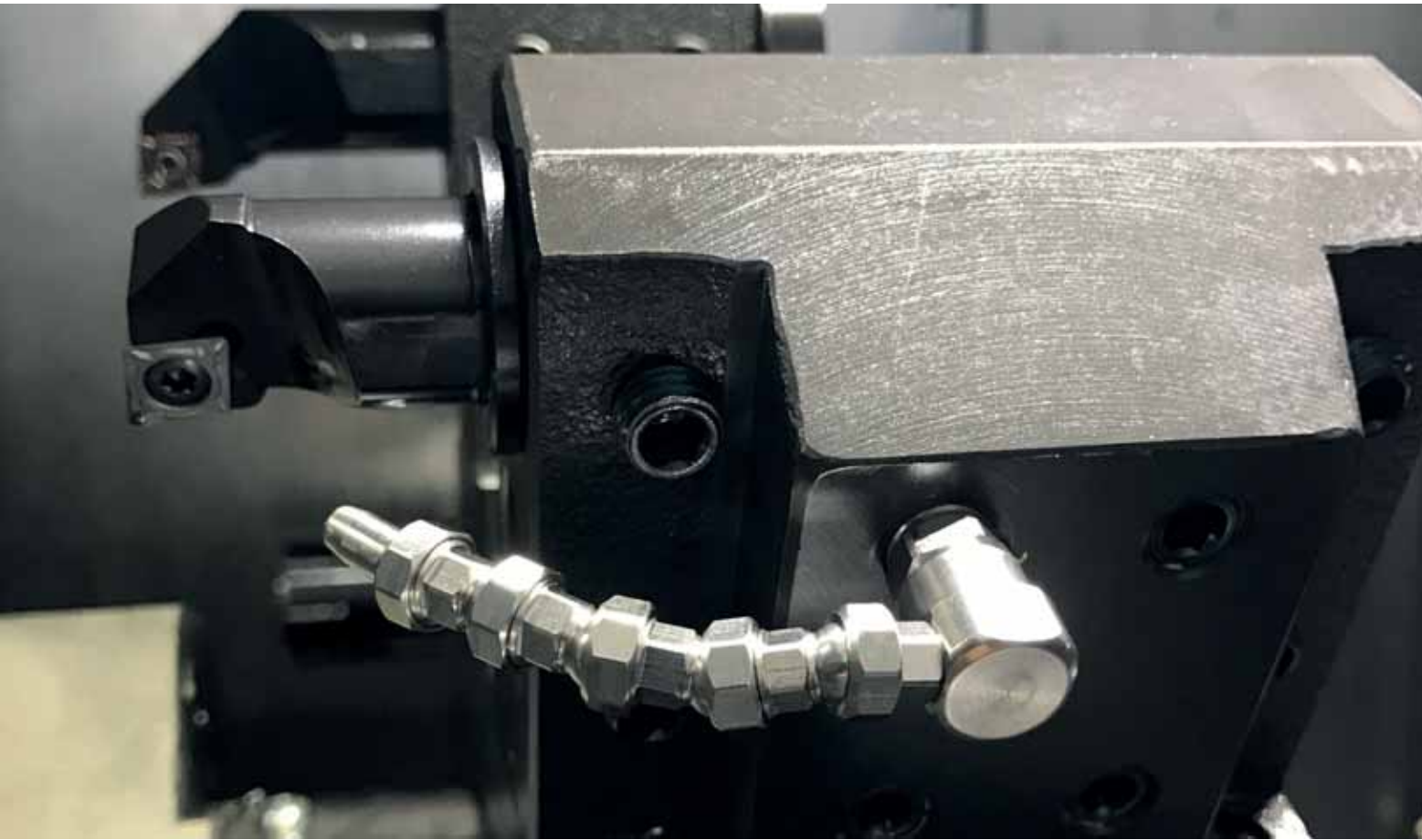

## Grundelemente | Basic Elements

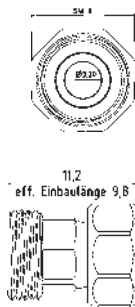

### 0-GE

$l = 11,2$  mm effektiv  $l = 9,8$  mm  
 $l = 11,2$  mm effective  $l = 9,8$  mm

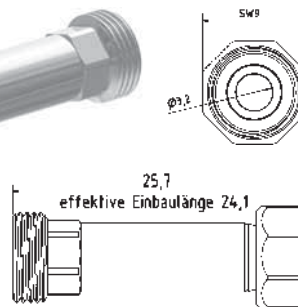

### 0-GE-25

$l = 25,7$  mm effektiv  $l = 24,1$  mm  
 $l = 25,7$  mm effective  $l = 24,1$  mm

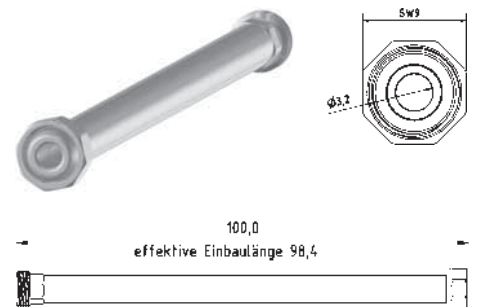

### 0-GE-100

$l = 100$  mm effektiv  $l = 98,4$  mm  
 $l = 100$  mm effective  $l = 98,4$  mm

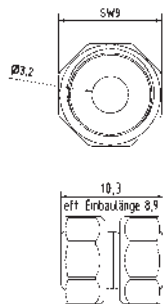

### 0-GE-DK Special element

$l = 10,3$  mm effektiv  $l = 8,9$  mm Doppelkugel  
 $l = 10,3$  mm effective  $l = 8,9$  mm double ball

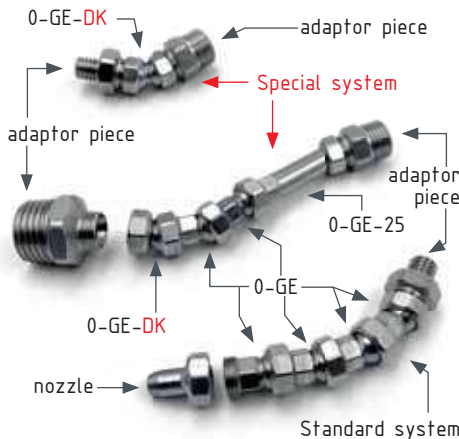

**Maschinen-/Düsenadapter | Machine-/Nozzle Adapter**

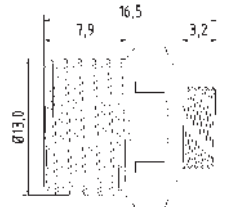
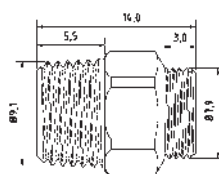
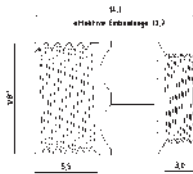
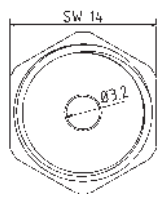

**0-AD-18**

Adapterstück G 1/8"  
adaptor piece thread 1/8"

**0-AD-18-PT**

Adapterstück G 1/8" PT (Withworth-Gewinde)  
adaptor piece thread 1/8" PT (NPT thread)

**0-AD-14**

Adapterstück G 1/4"  
adaptor piece thread 1/4"

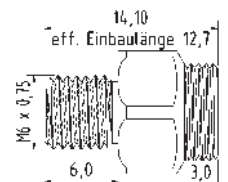
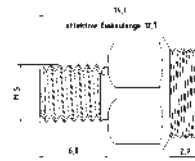
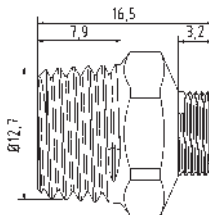

**0-AD-14-PT**

Adapterstück G 1/4" PT (Withworth-Gewinde)  
adaptor piece thread 1/4" PT (NPT thread)

**0-AD-M5**

Adapterstück M 5 x 0,8  
adaptor piece M 5 x 0,8 metric thread

**0-AD-6075**

Adapterstück M6 x 0,75  
adaptor piece M6 x 0,75 metric thread

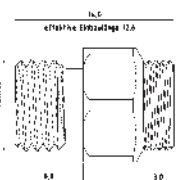
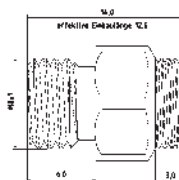
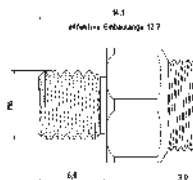
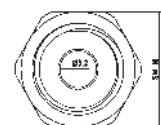
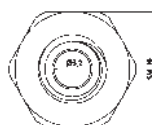

**0-AD-M6**

Adapterstück M 6 x 1  
adaptor piece M 6 x 1 metric thread

**0-AD-81**

Adapterstück M 8 x 1  
adaptor piece M 8 x 1 metric thread

**0-AD-M8**

Adapterstück M 8 x 1,25  
adaptor piece M 8 x 1,25 metric thread

# Type0 [1/8" System]

## Maschinen-/Düsenadapter | Machine-/Nozzle Adapter

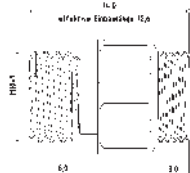

### 0-AD-M101

Adapterstück M 10 x 1  
adaptor piece M 10 x 1 metric thread

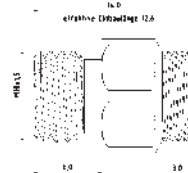
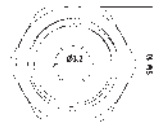

### 0-AD-M10

Adapterstück M 10 x 1,5  
adaptor piece M 10 x 1,5 metric thread

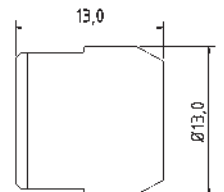
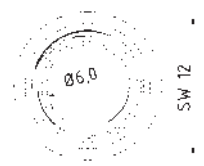
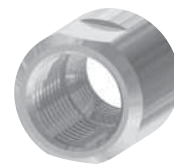

### 0-AD-0GE-18

Adapterstück für Fremddüsen mit Außengewinde, IG 0-GE auf IG 1/8"  
adaptor piece for external nozzles with male thread, female 0-GE to female 1/8"

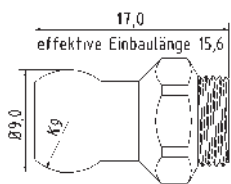
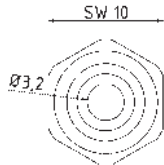

### 0-AD-K9

Adapterstück Kugel Ø 9  
adaptor piece ball Ø 9 mm

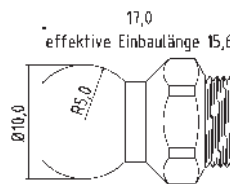
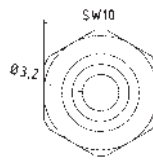

### 0-AD-K10

Adapterstück Kugel Ø10  
adaptor piece ball Ø10

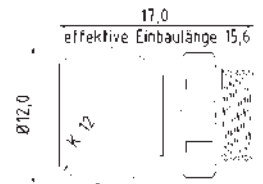
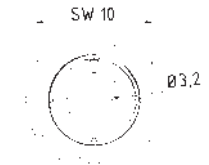
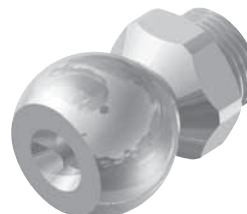

### 0-AD-K12

Adapterstück Kugel Ø 12 (z.B. MORI SEIKI)  
adaptor piece ball Ø 12 mm (e.g. MORI SEIKI)

## Winklelemente | Elbows

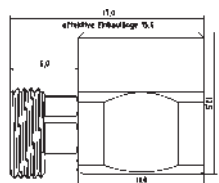
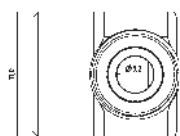

### 0-WV-1

Winkelverschraubung  
elbow piece fixed

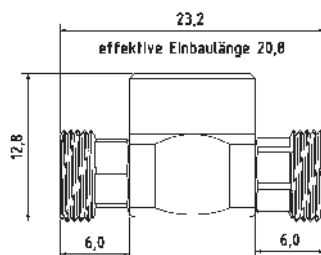
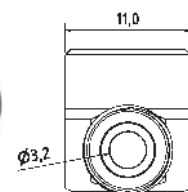

### 0-WV-2

T-Stück  
T-piece fixed

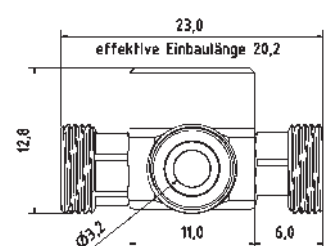
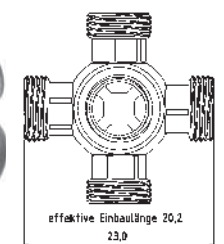

### 0-WV-4

Mehrfachverteiler  
Manifold

## Winkelemente | Elbows

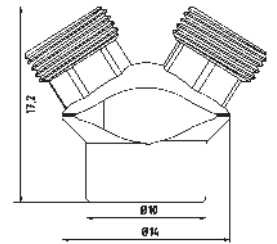
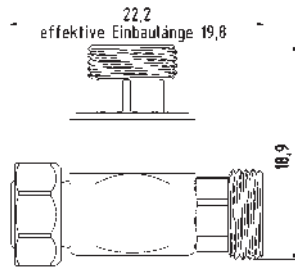
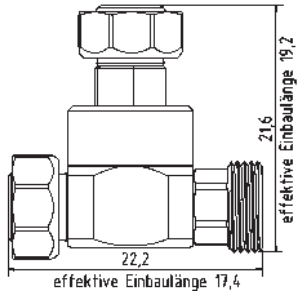
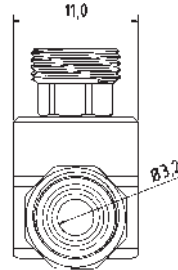
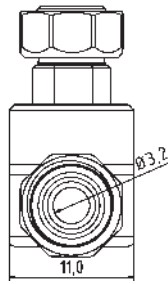
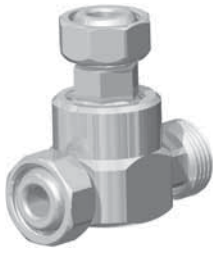

### 0-WV-R

Verschlussstück zu Ringdüse  
*locking tappet to ring nozzle*

### 0-WV-R-2K

T-Stück für Ring und Düse  
*T-piece for ring and nozzle*

### 0-YV

Y-Stück  
*Y-piece fixed*

## Düsen | Nozzles

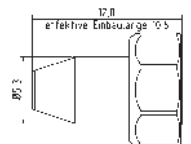
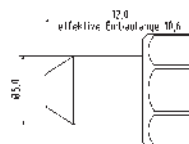
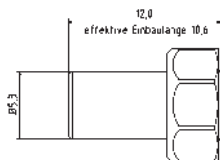
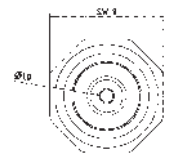
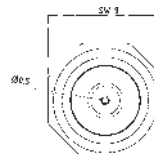
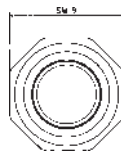

### 0-DU-0

Düse ohne Bohrung  
*nozzle straight without drilling*

### 0-DU-05

Düse gerade Bohrung Ø 0,5 mm  
*nozzle straight Ø 0,5 mm*

### 0-DU-10

Düse gerade Bohrung Ø 1,0 mm  
*nozzle straight Ø 1,0 mm*

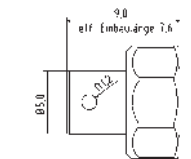
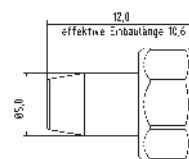
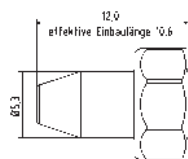
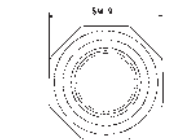
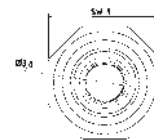

### 0-DU-20

Düse gerade Bohrung Ø 2,0 mm  
*nozzle straight Ø 2,0 mm*

### 0-DU-30

Düse gerade Bohrung Ø 3,0 mm  
*nozzle straight Ø 3,0 mm*

### 0-DU-90-1

Düse 90° Bohrung 1 x Ø 1,2 mm  
*nozzle 90° drill hole 1 x Ø 1,2 mm*

# Type0 [1/8" System]

## Düsen | Nozzles

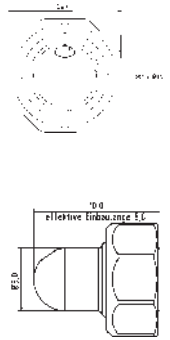
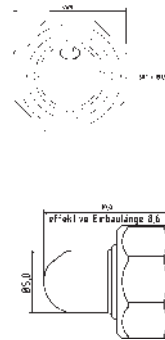
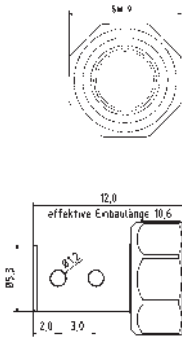

### O-DU-90-2

Düse 90° Bohrung 2 x Ø 1,2 mm  
nozzle 90° drill hole 2 x Ø 1,2 mm

### O-DU-30-1.5

Düse 30° Bohrung Ø 1,5 mm  
nozzle 30° drill hole Ø 1,5 mm

### O-DU-60-1.5

Düse 60° Bohrung Ø 1,5 mm  
nozzle 60° drill hole Ø 1,5 mm

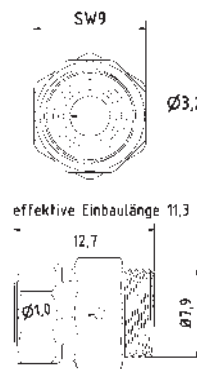
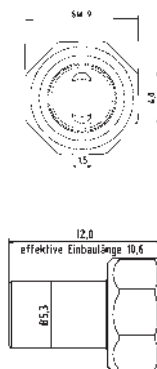

### O-DU-415

Düse mit Schlitz 4 x 1,5 mm  
nozzle straight with slit 4 x 1,5 mm

### O-DU-R

Ringdüsen Element Bohrung Ø 1,0 mm  
ring nozzle element drill hole Ø 1,0 mm

## Zubehör | Accessories

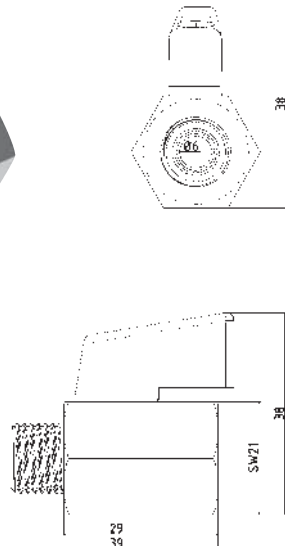
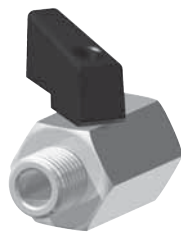
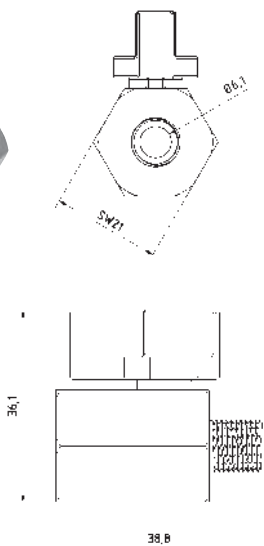
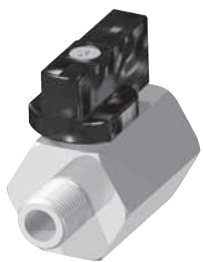

### KH-18

Mini-Kugelhahn G1/8" Messing Verchromt  
mini ball valve thread 1/8" brass chrome-plated

### KH-18-SS

Mini-Kugelhahn G1/8" Edelstahl  
mini ball valve thread 1/8" stainless steel

### KH-14

Mini-Kugelhahn G1/4" Messing Verchromt  
mini ball valve thread 1/4" brass chrome-plated

### KH-14-SS

Mini-Kugelhahn G1/4" Edelstahl  
mini ball valve thread 1/4" stainless steel



### O-MU

Mutter Standard  
screw nut (default)

**Zubehör | Accessories**

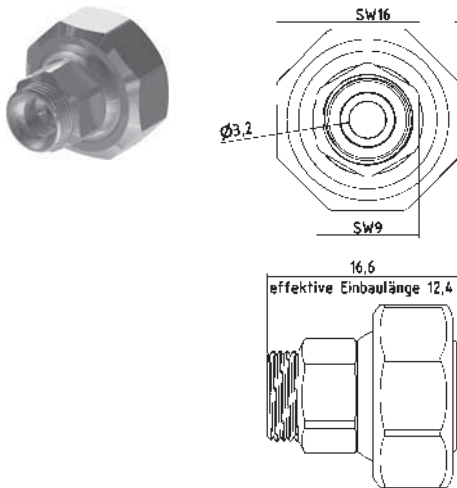

**RE-1-0**

Reduktion Typ 1 auf Typ 0  
*reduction Type 1 to Type 0*



**SW-6**

Schlüssel aus Stahl SW 6  
*open end wrench SW 6*



**SW-9**

Schlüssel aus Stahl SW 9  
*open end wrench SW 9*

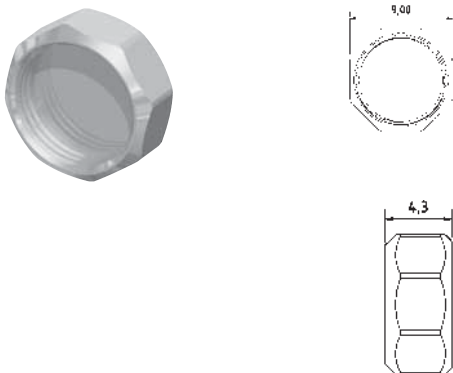

**0-VK**

Verschlusskappe Typ 0  
*cap type 0*

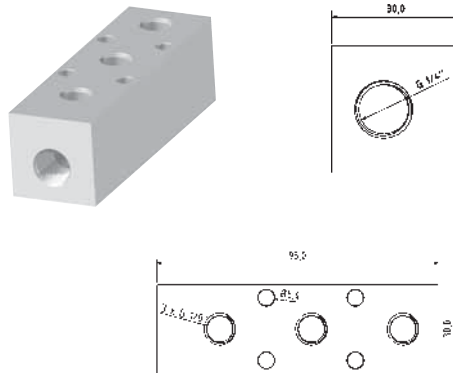

**VB-3-18**

Verteilerblock Eingang Stirnseite G1/4"  
*manifold block entrance front end 1/4"*

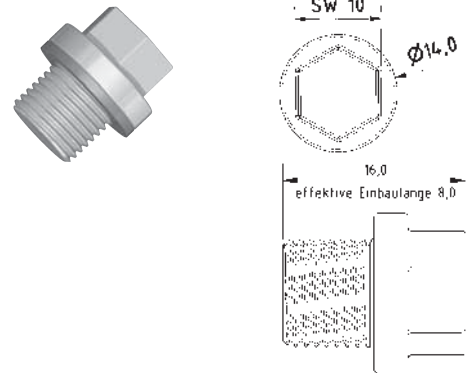

**VB-3-18-BS**

Blindstopfen G1/8"  
*blank plug with thread 1/8"*

**Grundset | Basic Set**

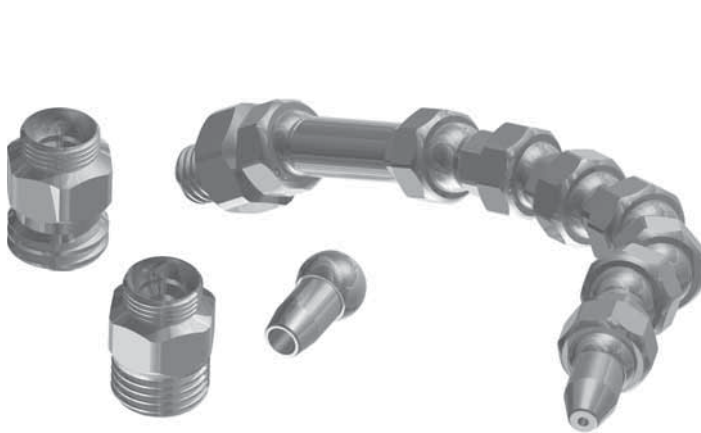

**0-GS**

Grundset Typ0 1/8" Zoll System L = 110 mm  
*basic set Type0 1/8" system l = 110 mm*

6 x 0-GE, 1 x 0-GE-25, 1 x 0-AD-18, 1 x 0-AD-M6, 1 x 0-AD-101, 1 x 0-DU-10  
1 x 0-DU-30, 1 x SW-6, 1 x SW-9



**0-GS-R**

Ringdüsen Set Ø = 60mm  
*(1 x 0-WV-R, 20 x 0-DU-R)*

ring nozzle set Ø = 60mm  
*(1 x 0-WV-R, 20 x 0-DU-R)*

## PRODUCT OVERVIEW

### Type1 [1/4"]



The Type 1 system for all machine applications in the range up to  $\pm 170$ l/min. With round nozzles sizes from  $\varnothing 1.6$  mm to  $\varnothing 5.0$  mm and a variety of flat nozzles and multi-bore nozzles, this system is a standard for every machine. The wide range of machine adapters from M8x1.0, M14x1.5 and G3/8" to various ball adapters with  $\varnothing 14.0$  mm and of course also basic and angled elements guarantee a smooth installation.

**TECHNICAL SPECIFICATIONS:**

- Size Type1 (1/4")
- Passage Ø5,8 mm
- Pressure resistant over 100 bar
- Application range -30°C to +60°C
- Optional ES-System up to +300°C (available on request)
- Thread (Elements) M14x1
- Material 1.4305 (V2A)

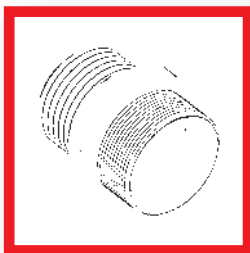
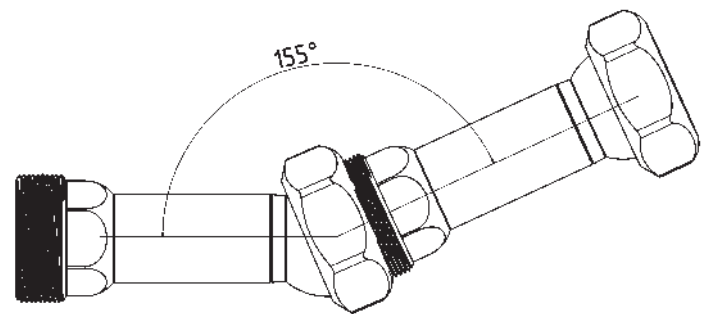
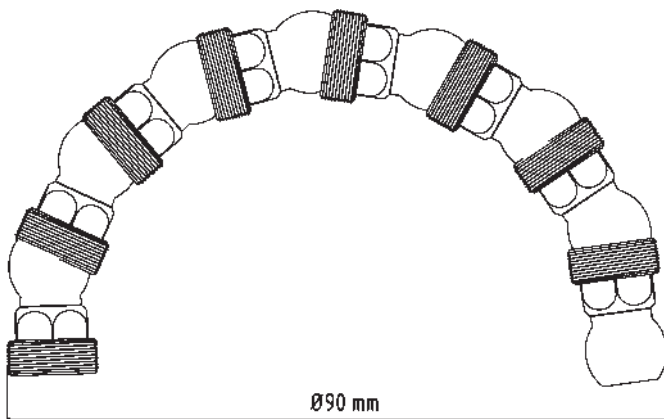

MACHINE ADAPTER



BASIC ELEMENTS



NOZZLES

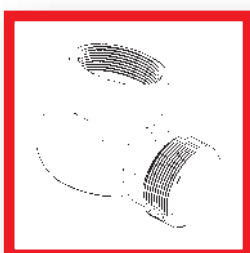

ELBOWS



ACCESSORIES



BASIC SET Type1



# Type1 [1/4" System]

## Grundelemente | Basic Elements

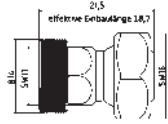
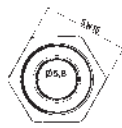

### 1-GE

$l = 21,5$  mm effektiv  $l = 18,7$  mm  
 $l = 21,5$  mm effective  $l = 18,7$  mm

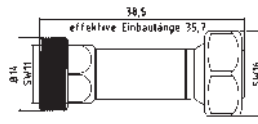
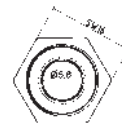

### 1-GE-2

$l = 38,5$  mm effektiv  $l = 35,7$  mm  
 $l = 38,5$  mm effective  $l = 35,7$  mm

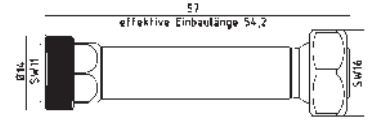
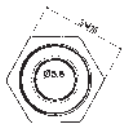

### 1-GE-3

$l = 57$  mm effektiv  $l = 54,2$  mm  
 $l = 57$  mm effective  $l = 54,2$  mm

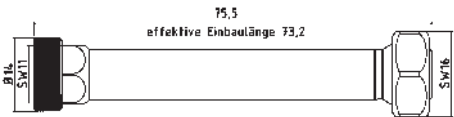
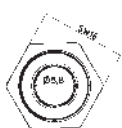

### 1-GE-4

$l = 75,5$  mm effektiv  $l = 73,2$  mm  
 $l = 75,5$  mm effective  $l = 73,2$  mm

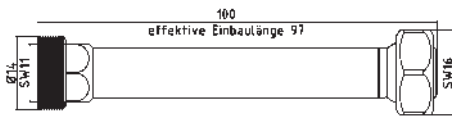
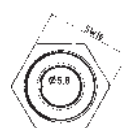

### 1-GE-100

$l = 100$  mm effektiv  $l = 97$  mm  
 $l = 100$  mm effective  $l = 97$  mm

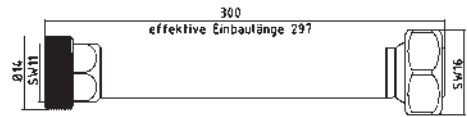
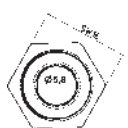

### 1-GE-300

$l = 300$  mm effektiv  $l = 297$  mm  
 $l = 300$  mm effective  $l = 297$  mm

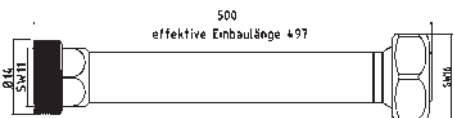
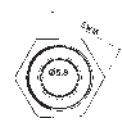

### 1-GE-500

$l = 500$  mm effektiv  $l = 497$  mm  
 $l = 500$  mm effective  $l = 497$  mm

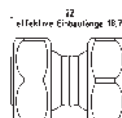
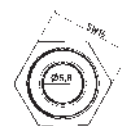

### 1-GE-DK Special element

$l = 22$  mm effektiv  $l = 18,7$  mm Doppelkugel  
 $l = 22$  mm effective  $l = 18,7$  mm double ball

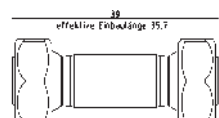
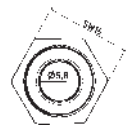

### 1-GE-2-DK Special element

$l = 39$  mm effektiv  $l = 35,7$  mm Doppelkugel  
 $l = 39$  mm effective  $l = 35,7$  mm double ball

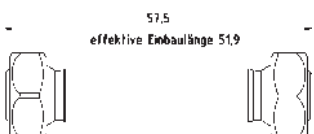
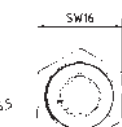

### 1-GE-3-DK Special element

$l = 57,5$  mm effektiv  $l = 51,9$  mm Doppelkugel  
 $l = 57,5$  mm effective  $l = 51,9$  mm double ball

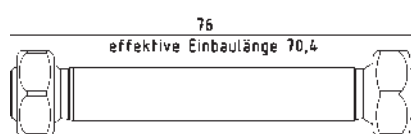
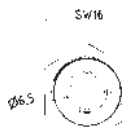

### 1-GE-4-DK Special element

$l = 76$  mm effektiv  $l = 70,4$  mm Doppelkugel  
 $l = 76$  mm effective  $l = 70,4$  mm double ball

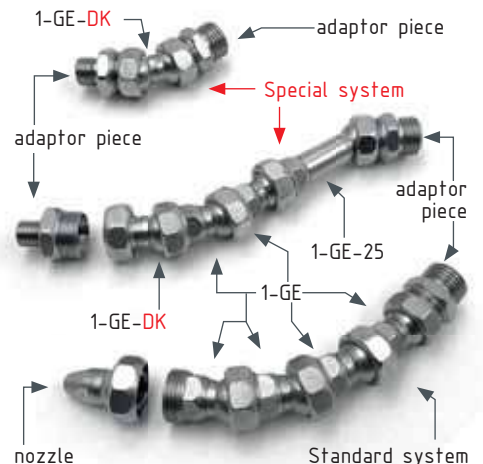

**Maschinen-/Düsenadapter | Machine-/Nozzle Adapter**

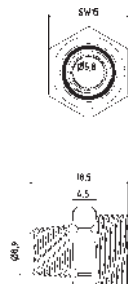

**1-AD-18**

Adapterstück G 1/8"  
adaptor piece thread 1/8"

**1-AD-18-PT**

Adapterstück G 1/8" PT (Withworth-Gewinde)  
adaptor piece thread 1/8" PT (NPT thread)

**1-AD-18-U**

Adapterstück G 1/8" U (Gewinde unterschritten)  
adaptor piece thread 1/8" U (Undercut thread)

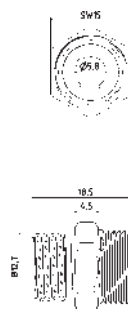
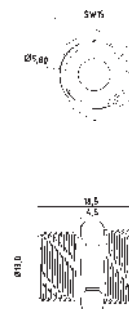

**1-AD-14**

Adapterstück G 1/4"  
adaptor piece thread 1/4"

**1-AD-14-PT**

Adapterstück G 1/4" PT (Withworth-Gewinde)  
adaptor piece thread 1/4" PT (NPT thread)

**1-AD-14-U**

Adapterstück G 1/4" U (Gewinde unterschritten)  
adaptor piece thread 1/4" U (Undercut thread)

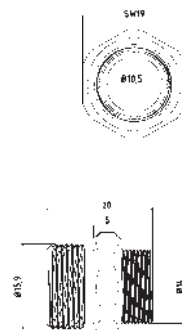
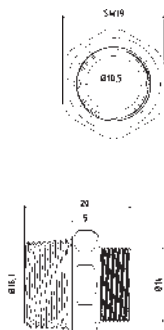
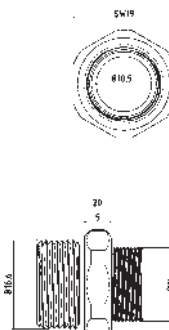

**1-AD-38**

Adapterstück G 3/8"  
adaptor piece thread 3/8"

**1-AD-38-PT**

Adapterstück G 3/8" PT (Withworth-Gewinde)  
adaptor piece thread 3/8" PT (NPT thread)

**1-AD-38-U**

Adapterstück G 3/8" U (Gewinde unterschritten)  
adaptor piece thread 3/8" U (Undercut thread)

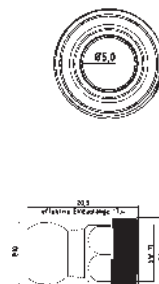

**1-AD-9-16-18UNF**

Adapterstück G 9/16"  
adaptor piece thread 9/16"

**1-AD-1-16PT**

Adapterstück G 1/16" PT (Withworth-Gewinden)  
adaptor piece thread 1/16" PT (NPT thread)

**1-AD-K10**

Adapterstück Kugel Ø 10 (z.B. Traub)  
adaptor piece ball Ø 10 mm (e.g. Traub)

# Type1 [1/4" System]

## Maschinen-/Düsenadapter | Machine-/Nozzle Adapter

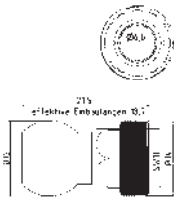

### 1-AD-K12

Adapterstück Kugel Ø 12 (z.B. MORI SEIKI)  
*adaptor piece ball Ø 12 mm (e.g. MORI SEIKI)*

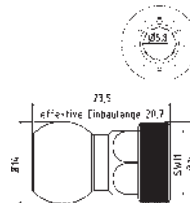

### 1-AD-K14

Adapterstück Kugel Ø 14 (z.B. Wenk)  
*adaptor piece ball Ø 14 mm (e.g. Wenk)*

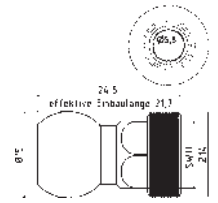

### 1-AD-K15

Adapterstück Kugel Ø 15 (z.B. Okuma)  
*adaptor piece ball Ø 15 mm (e.g. Okuma)*

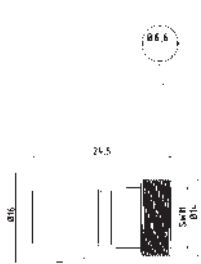

### 1-AD-K16

Adapterstück Kugel Ø 16 (z.B. Okuma)  
*adaptor piece ball Ø 16 mm (e.g. Okuma)*

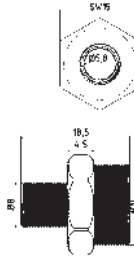

### 1-AD-81

Adapterstück M8 x 1  
*adaptor piece M8 x 1 metric thread*

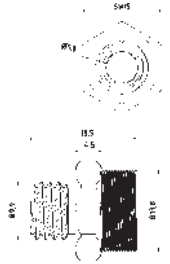

### 1-AD-101

Adapterstück M10 x 1  
*adaptor piece M10 x 1 metric thread*

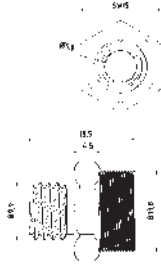

### 1-AD-101.5

Adapterstück M10 x 1,5  
*adaptor piece M10 x 1,5 metric thread*



### 1-AD-121

Adapterstück M 12 x 1  
*adaptor piece M 12 x 1 metric thread*

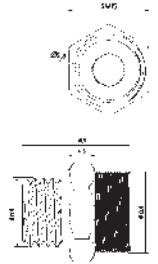

### 1-AD-121.5

Adapterstück M 12 x 1,5  
*adaptor piece M 12 x 1,5 metric thread*



### 1-AD-131.5

Adapterstück M 13 x 1,5  
*adaptor piece M 13 x 1,5 metric thread*

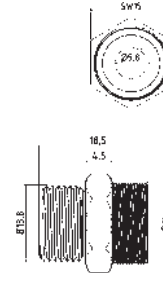

### 1-AD-141

Adapterstück M 14 x 1  
*adaptor piece M 14 x 1 metric thread*

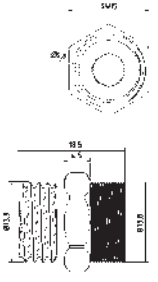

### 1-AD-141.5

Adapterstück M 14 x 1,5  
*adaptor piece M 14 x 1,5 metric thread*

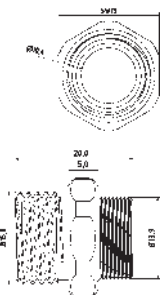

### 1-AD-161.5

Adapterstück M 16 x 1,5  
*adaptor piece M 16 x 1,5 metric thread*

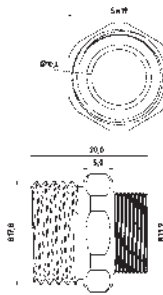

### 1-AD-181.5

Adapterstück M 18 x 1,5  
*adaptor piece M 18 x 1,5 metric thread*

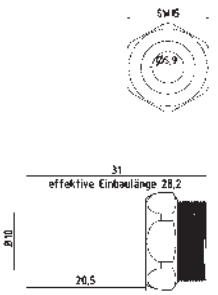

### 1-AD-10L

Adapterstück zu Hydraulik-Verschraubung 10 L  
*adaptor piece to hydraulic system 10 L*

**Maschinen-/Düsenadapter | Machine-/Nozzle Adapter**

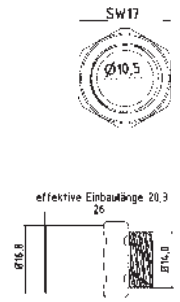

**1-AD-I121-Typ1**

Adapterstück M12 x 1 Innengewinde auf Hirt-Line Typ1 Aussengewinde  
*adaptor piece M12 x 1 female thread to Hirt-Line type1 male thread*

**1-AD-I121.5-Typ1**

Adapterstück M12 x 1.5 Innengewinde auf Hirt-Line Typ1 Aussengewinde  
*adaptor piece M12 x 1.5 female thread to Hirt-Line type1 male thread*

**1-AD-I141.5-Typ1**

Adapterstück M14 x 1.5 Innengewinde auf Hirt-Line Typ1 Aussengewinde  
*adaptor piece M14 x 1.5 female thread to Hirt-Line type1 male thread*

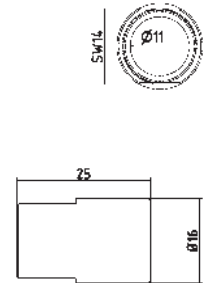
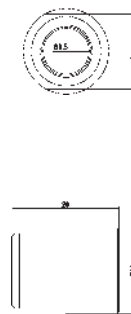
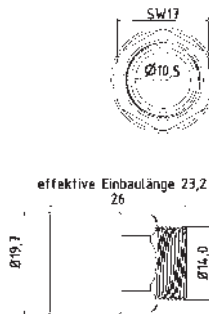

**1-AD-I161.5-Typ1**

Adapterstück M16 x 1.5 Innengewinde auf Hirt-Line Typ1 Aussengewinde  
*adaptor piece M16 x 1.5 female thread to Hirt-Line type1 male thread*

**1-AD-1GE-18**

Adapterstück für Fremddüsen mit Außengewinde, IG 1-GE auf IG 1/8"  
*adapter piece for external nozzles with male thread, female 1-GE to female 1/8"*

**1-AD-1GE-14**

Adapterstück für Fremddüsen mit Außengewinde, IG 1-GE auf IG 1/4"  
*adapter piece for external nozzles with male thread, female 1-GE to female 1/4"*

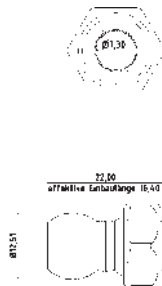

**1-AD-LL**

Adapterstück Loc-Line Typ 1  
*adaptor piece Loc-Line Type 1*

**1-AD-RSV-14**

Adapterstück mit Rückschlagventil G1/4"  
*adaptor piece with check valve G1/4"*

**1-AD-RSV-38**

Adapterstück mit Rückschlagventil G3/8"  
*adaptor piece with check valve G3/8"*

# Type1 [1/4" System]

## Winkelelemente | Elbows

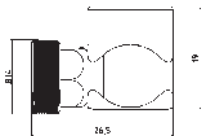
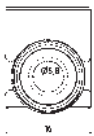

### 1-WV-1

Winkelverschraubung  
elbow piece fixed

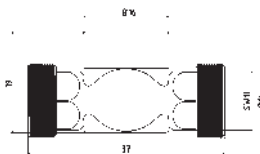

### 1-WV-2

T-Stück  
T-piece fixed

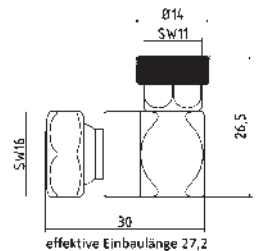
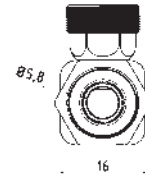

### 1-WV-1K

Winkelverschraubung mit Kugelstück  
elbow piece moveable

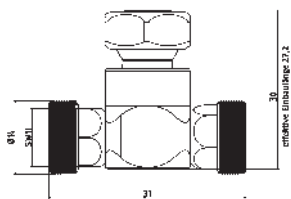
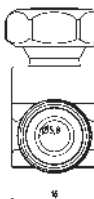

### 1-WV-2K

T-Stück mit Kugelstück  
T-piece moveable

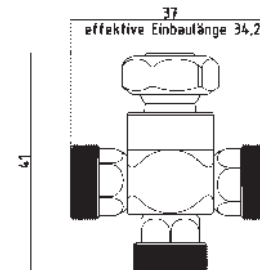
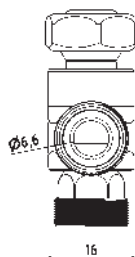

### 1-WV-3K

Kreuz-Stück mit Kugelstück  
cross piece moveable

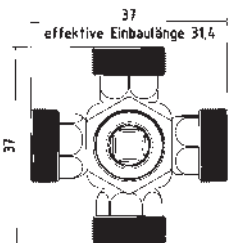
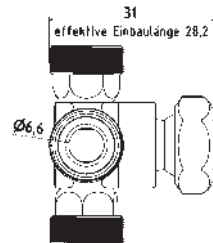

### 1-WV-4K

Stern-Stück mit Kugelstück  
star piece moveable

## Winkelemente | Elbows

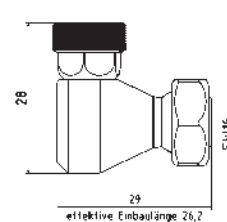
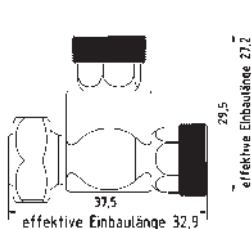
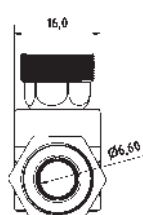
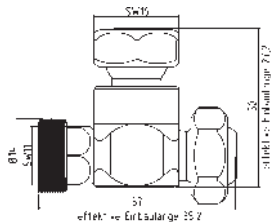

### 1-WV-R

Verschlussstück zu Ringdüse  
locking tappet to ring nozzle

### 1-WV-R-2K

T-Stück für Ring und Düse  
T-piece for ring and nozzle

### 1-WI

Winkelstück für Leitungen  
corner piece for pipelines

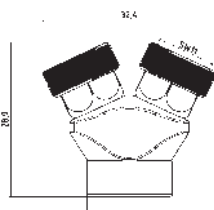

### 1-YV

Y-Stück 50°  
Y-piece 50°



## Düsen | Nozzles

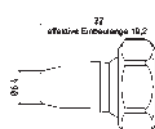
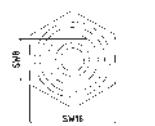

### 1-DU-0

Düse ohne Bohrung  
nozzle straight without drilling

### 1-DU-16

Düse gerade Bohrung Ø 1,6 mm  
nozzle straight Ø 1,6 mm

### 1-DU-32

Düse gerade Bohrung Ø 3,2 mm  
nozzle straight Ø 3,2 mm

# Type1 [1/4" System]

## Düsen | Nozzles



### 1-DU-50

Düse gerade Bohrung  $\varnothing$  5,0 mm  
nozzle straight  $\varnothing$  5,0 mm

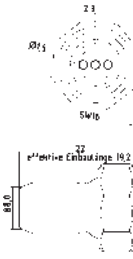

### 1-DU-3-16

Düse gerade Bohrung 3 x  $\varnothing$  1,6 mm  
nozzle straight 3 x  $\varnothing$  1,6 mm

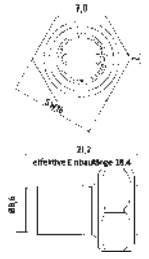

### 1-DU-72

Düse mit Schlitz 7 x 2,0 mm  
nozzle straight with slit 7 x 2,0 mm

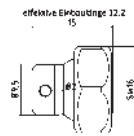

### 1-DU-90-1

Düse 90° Bohrung 1 x  $\varnothing$  2 mm  
nozzle 90° drill hole 1 x  $\varnothing$  2 mm

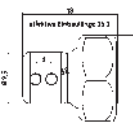

### 1-DU-90-2

Düse 90° Bohrung 2 x  $\varnothing$  2 mm  
nozzle 90° drill hole 2 x  $\varnothing$  2 mm

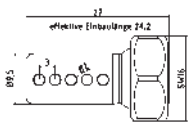

### 1-DU-90-5

Düse 90° Bohrung 5 x  $\varnothing$  2 mm  
nozzle 90° drill hole 5 x  $\varnothing$  2 mm

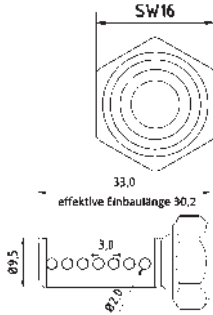
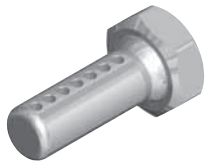

### 1-DU-90-7

Düse 90° Bohrung 7 x  $\varnothing$  2 mm  
nozzle 90° drill hole 7 x  $\varnothing$  2 mm

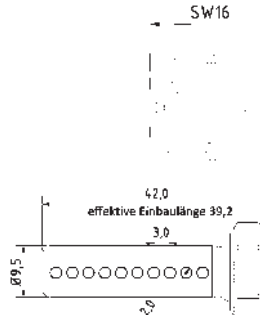

### 1-DU-90-10

Düse 90° Bohrung 10 x  $\varnothing$  2 mm  
nozzle 90° drill hole 10 x  $\varnothing$  2 mm

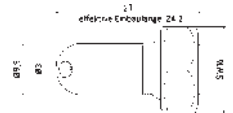

### 1-DU-30

Düse 30° Bohrung  $\varnothing$  3 mm  
nozzle 30° drill hole  $\varnothing$  3 mm

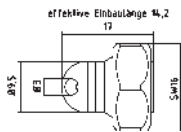

### 1-DU-30-EK

Düse 30° Bohrung  $\varnothing$  3 mm extra kurz  
nozzle 30° drill hole  $\varnothing$  3 mm extra short

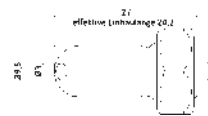

### 1-DU-60

Düse 60° Bohrung  $\varnothing$  3 mm  
nozzle 60° drill hole  $\varnothing$  3 mm

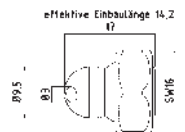
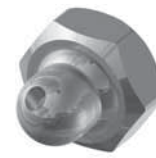

### 1-DU-60-EK

Düse 60° Bohrung  $\varnothing$  3 mm extra kurz  
nozzle 60° drill hole  $\varnothing$  3 mm extra short

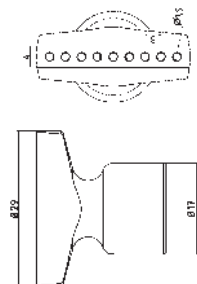

### 1-DU-BL

Düse Breit mit Bohrungen 9 x  $\varnothing$  1,5 mm  
nozzle broadly with drillings 9 x  $\varnothing$  1,5 mm

**Düsen | Nozzles**

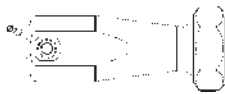
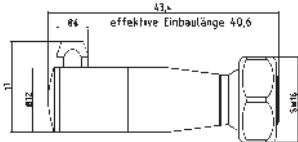

**1-HA-DU**

Halterung Düse klein I = 40 inkl. 3 Düsen  
small nozzle holder I = 40 incl. 3 nozzles

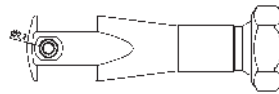
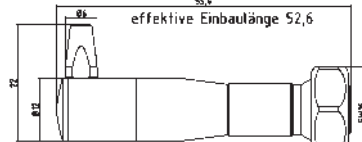
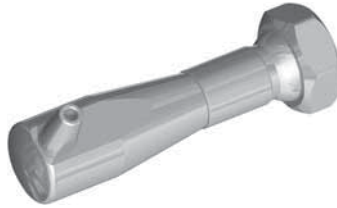

**1-HA-DU-2**

Halterung Düse klein I = 55 inkl. 3 Düsen  
small nozzle holder I = 55 incl. 3 nozzles

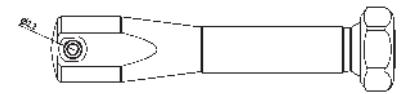
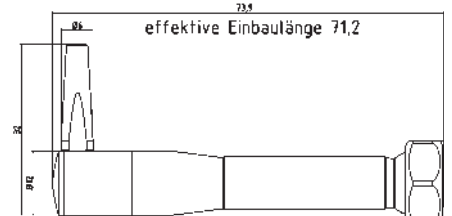

**1-HA-DU-3**

Halterung Düse klein I = 70 inkl. 3 Düsen  
small nozzle holder I = 70 incl. 3 nozzles

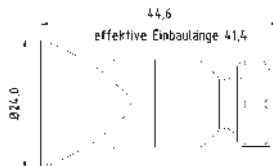
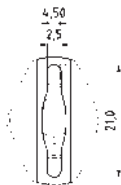

**1-DU-SL-SS**

Flachdüse Breit mit Schlitz 21 x 2,5 mm  
Streustrahl  
flat nozzle broadly with slit 21 x 2,5 mm  
scattered beam

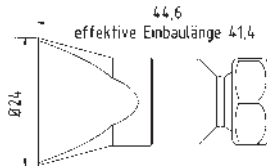
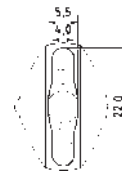

**1-DU-SL-25**

Flachdüse Breit mit Schlitz 22 x 4,0 mm  
Streustrahl zum Schwemmen  
flat nozzle broadly with slit 22 x 4,0 mm  
scattered beam

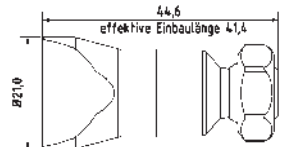
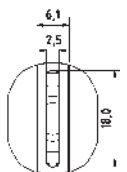

**1-DU-SL-GS**

Flachdüse Breit mit Schlitz 18 x 2,5 mm  
gerader Strahl  
flat nozzle broadly with slit 18 x 2,5 mm  
straight jet

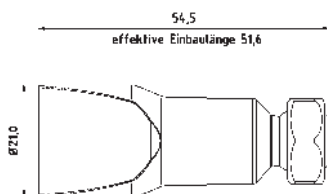
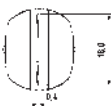

**1-DU-SL-25-GS-0.4**

Flachdüse Breit mit Schlitz 18 x 0,4 mm  
gerader Strahl  
flat nozzle broadly with slit 18 x 0,4 mm  
straight jet

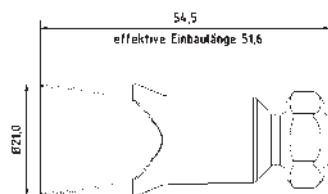
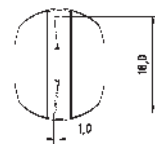

**1-DU-SL-25-GS-1.0**

Flachdüse Breit mit Schlitz 18 x 1,0 mm  
gerader Strahl  
flat nozzle broadly with slit 18 x 1,0 mm  
straight jet

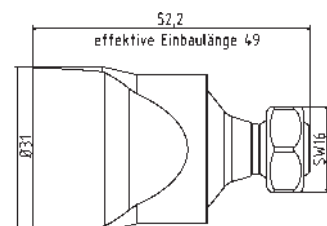
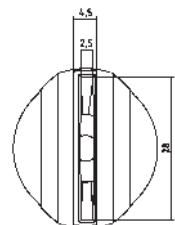

**1-DU-SL-31-GS**

Flachdüse Breit mit Schlitz 28 x 2,5 mm  
gerader Strahl  
flat nozzle broadly with slit 28 x 2,5 mm  
straight jet



# Type1 [1/4" System]

## Düsen | Nozzles

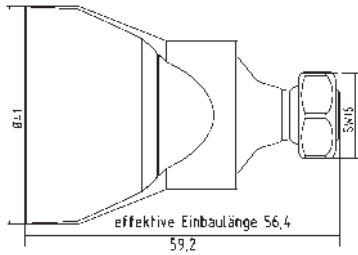
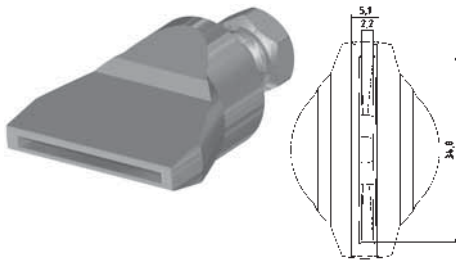

### 1-DU-SL-50-GS

Flachdüse Schlitzbreite 35 x 2,2 mm  
gerader Strahl  
*flat nozzle broadly with slit 35 x 2,2 mm  
straight jet*

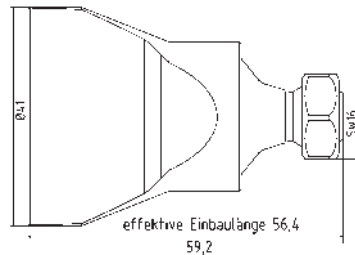
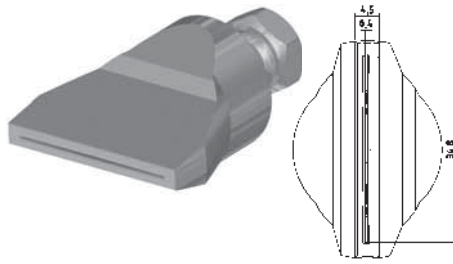

### 1-DU-SL-50-GS-0.4

Flachdüse Schlitzbreite 35 x 0,4 mm  
gerader Strahl  
*flat nozzle broadly with slit 35 x 0,4 mm  
straight jet*

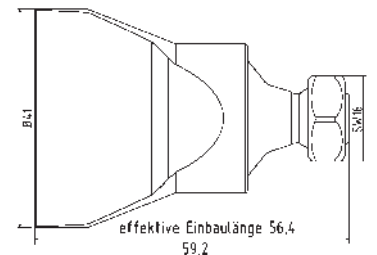
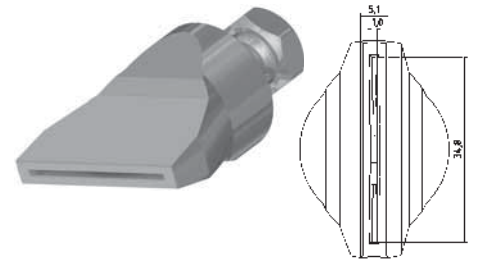

### 1-DU-SL-50-GS-1.0

Flachdüse Schlitzbreite 35 x 1,0 mm  
gerader Strahl  
*flat nozzle broadly with slit 35 x 1,0 mm  
straight jet*

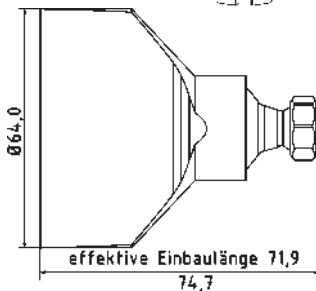
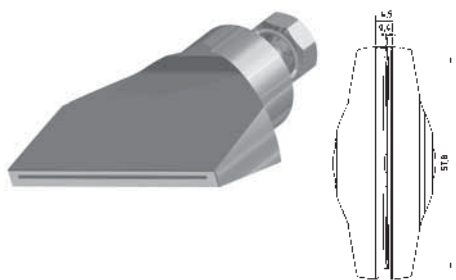

### 1-DU-SL-65-GS-0.4

Flachdüse Schlitzbreite 58 x 0,4 mm  
gerader Strahl  
*flat nozzle broadly with slit 58 x 0,4 mm  
straight jet*

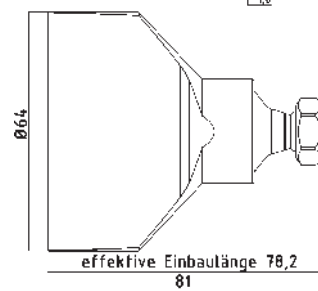
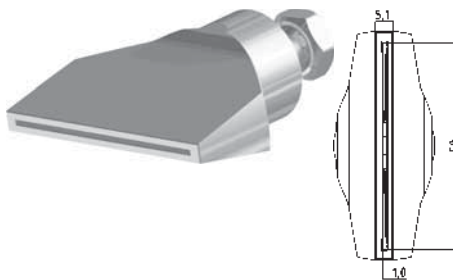

### 1-DU-SL-65-GS-1.0

Flachdüse Schlitzbreite 58 x 1,0 mm  
gerader Strahl  
*flat nozzle broadly with slit 58 x 1,0 mm  
straight jet*

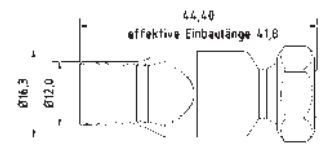
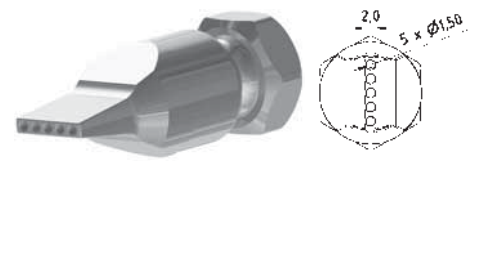

### 1-DU-LL-5-15

Düse gerade Bohrungen 5 x Ø 1,5 mm  
*nozzle straight drill hole 5 x Ø 1,5 mm*

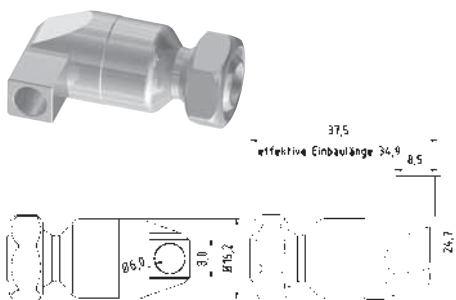

### 1-DU-LL-90-1-6

Düse 90° Bohrung 1 x Ø 6 mm  
*nozzle 90° drill hole 1 x Ø 6 mm*

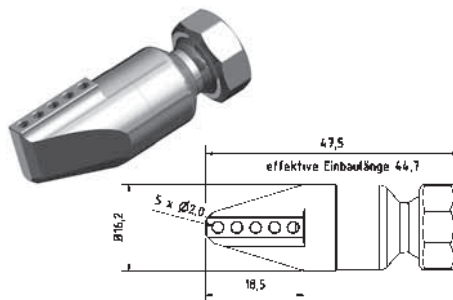

### 1-DU-LL-90-5-2

Düse 90° Bohrungen 5 x Ø 2 mm  
*nozzle 90° drill hole 5 x Ø 2 mm*

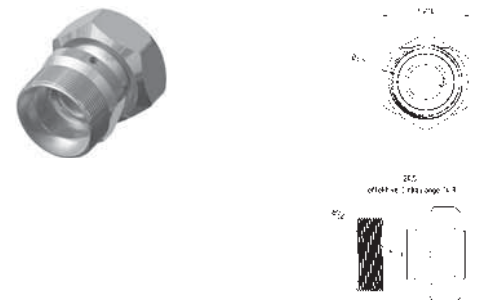

### 1-DU-R

Ringdüsen Element Bohrung Ø 1,6 mm  
*ring nozzle element drill hole Ø 1,6 mm*



# Type1 [1/4" System]

## Kugeldüsen | Ball Nozzles

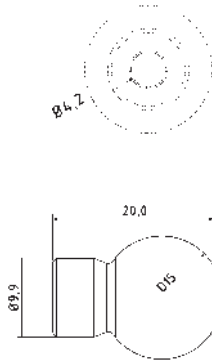

### 1-DU-K15-4.2

Düse für Werkzeughalter  
gerade Bohrung  $\varnothing$  4,2mm Kugel  $\varnothing$  15mm  
Nozzle for tool holder  
straight bore  $\varnothing$  4.2mm ball  $\varnothing$  15mm

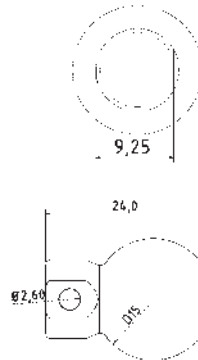

### 1-DU-K15-90-2.6

Düse für Werkzeughalter 90° Bohrung  $\varnothing$  2,6mm  
Kugel  $\varnothing$  15mm  
Nozzle for tool holder 90° bore  $\varnothing$  2,6mm  
ball  $\varnothing$  15mm

## Zubehör | Accessories

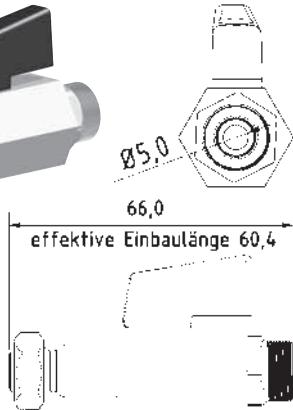
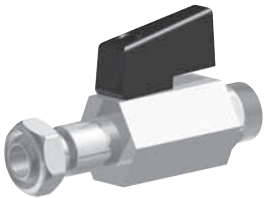

### 1-KH-Z

Kugelhahn Zwischenelement Typ1  
ball valve intermediate element type1

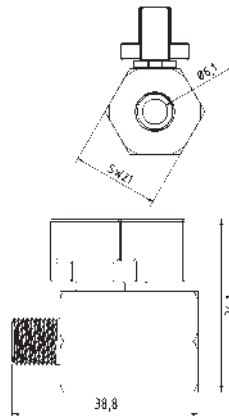
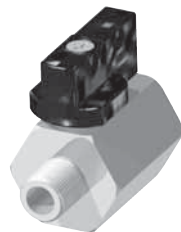

### KH-18

Mini-Kugelhahn G1/8" Messing Verchromt  
mini ball valve thread 1/8" brass chrome-plated

### KH-18-SS

Mini-Kugelhahn G1/8" Edelstahl  
mini ball valve thread 1/8" stainless steel

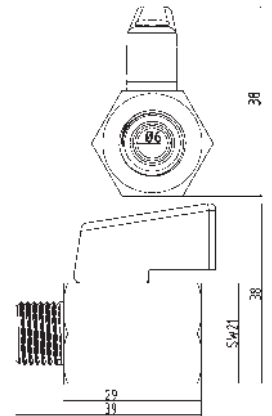

### KH-14

Mini-Kugelhahn G1/4" Messing Verchromt  
mini ball valve thread 1/4" brass chrome-plated

### KH-14-SS

Mini-Kugelhahn G1/4" Edelstahl  
mini ball valve thread 1/4" stainless steel

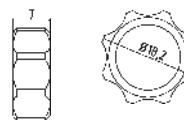
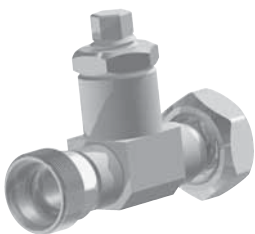

### 1-MU-HA

Mutter für Handverstellung  
screw nut (hand feed)

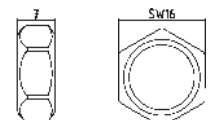
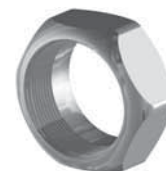

### 1-MU

Mutter Standard  
screw nut (default)

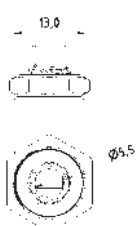

### 1-DRV

Drosselventil Typ1  
throttle valve type1

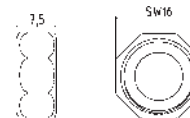
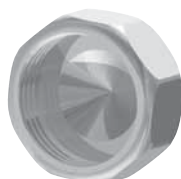

### 1-VK

Verschlusskappe Typ 1  
cap type 1

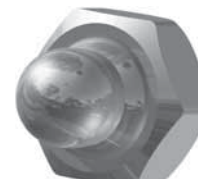

### 1-VER

Verschlussstopfen m. Mutter für Duschelement  
seal plug with screw nut for schowerelement

Zubehör | Accessories

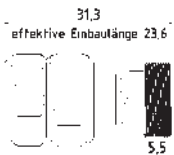
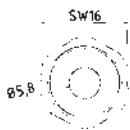

**1-FP**

Zwischenelement mit fester Position  
(Schnellkupplung)

Intermediate element with fixed position  
(quick coupling)

**SW-11**

Schlüssel aus Stahl SW11  
open end wrench SW11

**SW-16**

Schlüssel aus Stahl SW16  
open end wrench SW16

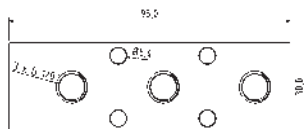
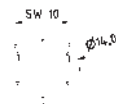
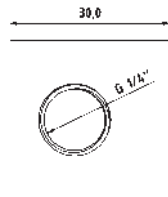

**VB-3-18**

Verteilerblock Eingang Stirnseite G1/4"  
manifold block entrance front end 1/4"

**VB-3-18-BS**

Blindstopfen G1/8"  
blank plug with thread 1/8"

Grundset | Basic Set

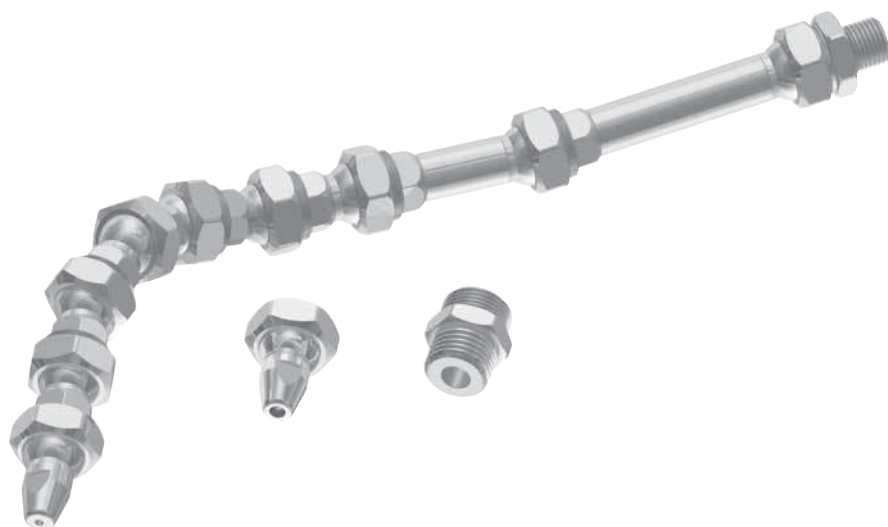

**1-GS**

Grundset Typ1 1/4" System L = 230 mm  
6 x 1-GE, 1 x 1-GE-2, 1 x 1-GE-3, 1 x 1-AD-18, 1 x 1-AD-14, 1 x 1-DU-16, 1 x 1-DU-32  
basic set Type1 1/4" system l = 230 mm:  
6 x 1-GE, 1 x 1-GE-2, 1 x 1-GE-3, 1 x 1-AD-18, 1 x 1-AD-14, 1 x 1-DU-16, 1 x 1-DU-32

**1-GS-R**

Ringdüsen Set (17 x 1-DU-R + 1 x 1-WV-R)  
Ø = 80 mm erweiterbar  
ring nozzle set (17 x 1-DU-R + 1 x 1-WV-R)  
Ø = 80 mm expendable

## PRODUCT OVERVIEW

### Type2 [1/2"]



With the Type 2 system you can optimize your machine process by  $\pm 12\%$ . Take advantage of the wide range of nozzles and adapt the cooling to your needs. Whether flat nozzles, round nozzles or nozzles with several outlets, for grinding, turning, milling or air cooling, you will find the suitable elements here. The Type 2 basic elements and machine adapters ensure a round range, which offers you the security of optimizing tool wear and guarantee stable cooling.

**TECHNICAL SPECIFICATIONS:**

- Size Type2 (1/2")
- Passage Ø11,0 mm
- Pressure resistant over 100 bar
- Application range -30°C to +60°C
- Optional ES-System up to +300°C (available on request)
- Thread (Elements) M24x1,25
- Material 1.4305 (V2A)

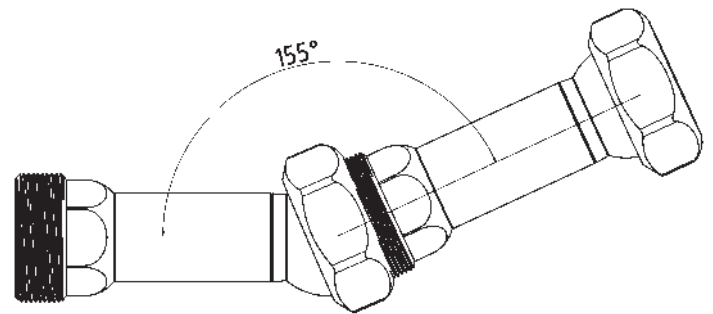
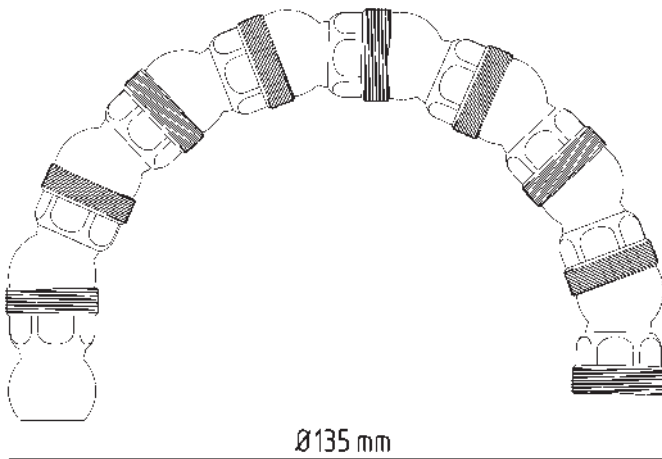

MACHINE ADAPTER

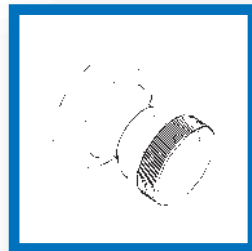

BASIC ELEMENTS



NOZZLES



ELBOWS

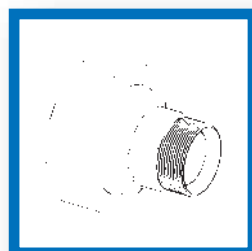

ACCESSORIES



BASIC SET Type2

# Type2 [1/2" System]

## Grundelemente | Basic Elements

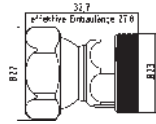
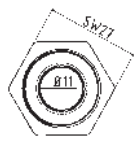

### 2-GE

l = 32,7 mm effektiv l = 27,8 mm  
l = 32,7 mm effective l = 27,8 mm

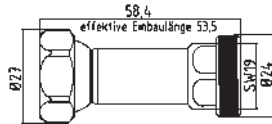
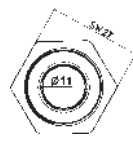

### 2-GE-2

l = 58,4 mm effektiv l = 53,5 mm  
l = 58,4 mm effective l = 53,5 mm

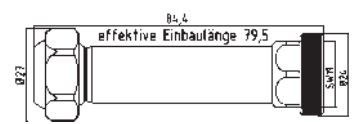
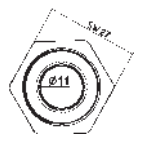

### 2-GE-3

l = 84,4 mm effektiv l = 79,5 mm  
l = 84,4 mm effective l = 79,5 mm

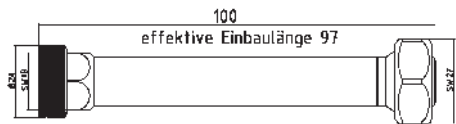
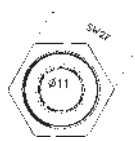

### 2-GE-100

l = 100 mm effektiv l = 97 mm  
l = 100 mm effective l = 97 mm

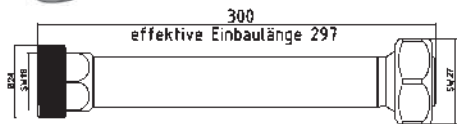

### 2-GE-300

l = 300 mm effektiv l = 297 mm  
l = 300 mm effective l = 297 mm

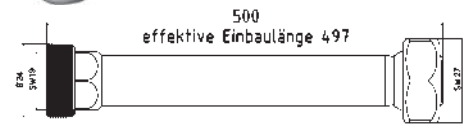
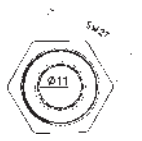

### 2-GE-500

l = 500 mm effektiv l = 497 mm  
l = 500 mm effective l = 497 mm

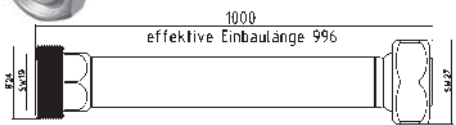
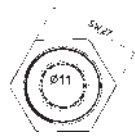

### 2-GE-1000

l = 1000 mm effektiv l = 996 mm  
l = 1000 mm effective l = 996 mm

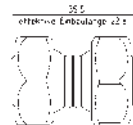
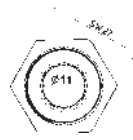

### 2-GE-DK Special element

l = 35,5 mm effektiv l = 22,8 mm Doppelkugel  
l = 35,5 mm effective l = 22,8 mm double ball

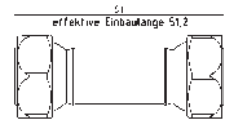
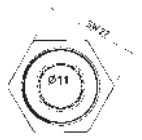

### 2-GE-2-DK Special element

l = 61 mm effektiv l = 51,2 mm Doppelkugel  
l = 61 mm effective l = 51,2 mm double ball

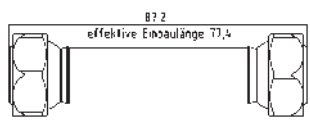
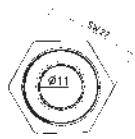

### 2-GE-3-DK Special element

l = 87,2 mm effektiv l = 77,4 mm Doppelkugel  
l = 87,2 mm effective l = 77,4 mm double ball

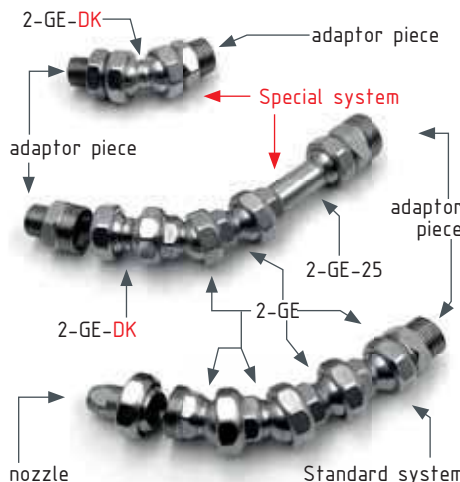

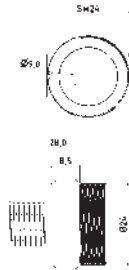

**2-AD-14**

Adapterstück G 1/4"  
adaptor piece thread 1/4"

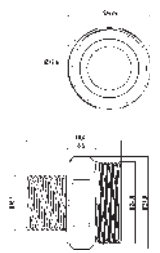
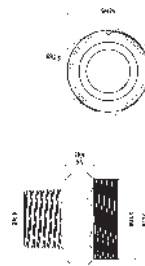

**2-AD-38**

Adapterstück G 3/8"  
adaptor piece thread 3/8"

**2-AD-38-PT**

Adapterstück G 3/8" PT (Withworth-Gewinde)  
adaptor piece thread 3/8" PT (NPT thread)

**2-AD-38-U**

Adapterstück G 3/8" U (Gewinde unterschritten)  
adaptor piece thread 3/8" U (Undercut thread)

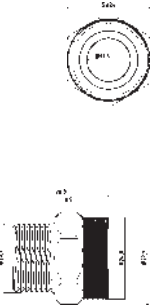
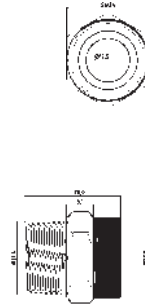

**2-AD-12**

Adapterstück G 1/2"  
adaptor piece thread 1/2"

**2-AD-12-PT**

Adapterstück G 1/2" PT (Withworth-Gewinde)  
adaptor piece thread 1/2" PT (NPT thread)

**2-AD-12-U**

Adapterstück G 1/2" U (Gewinde unterschritten)  
adaptor piece thread 1/2" U (Undercut thread)

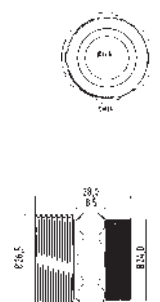
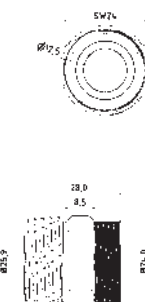
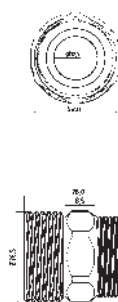

**2-AD-34**

Adapterstück G 3/4"  
adaptor piece thread 3/4"

**2-AD-34-PT**

Adapterstück G 3/4" PT (Withworth-Gewinde)  
adaptor piece thread 3/4" PT (NPT thread)

**2-AD-34-U**

Adapterstück G 3/4" U (Gewinde unterschritten)  
adaptor piece thread 3/4" U (Undercut thread)



# Type2 [1/2" System]

## Maschinen-/Düsenadapter | Machine-/Nozzle Adapter

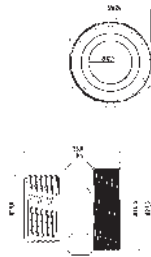

### 2-AD-201.5

Adapterstück M20 x 1.5"  
*adaptor piece thread M20 x 1.5"*

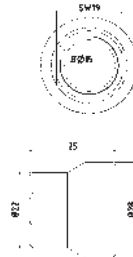

### 2-AD-2GE-38

Adapterstück für Fremddüsen mit  
 Außengewinde, IG 2-GE auf IG 3/8"  
*adapter piece for external nozzles with  
 male thread, female 2-GE to female 3/8"*



### 2-AD-2GE-12

Adapterstück für Fremddüsen mit  
 Außengewinde, IG 2-GE auf IG 1/2"  
*adapter piece for external nozzles with  
 male thread, female 2-GE to female 1/2"*

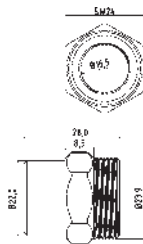

### 2-AD-I161.5-Typ2

Adapterstück M16 x 1.5 Innengewinde auf  
 Hirt-Line Typ2 Aussengewinde  
*adaptor piece M16 x 1.5 female thread  
 to Hirt-Line type2 male thread*

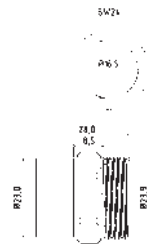

### 2-AD-I181.5-Typ2

Adapterstück M18 x 1.5 Innengewinde auf  
 Hirt-Line Typ2 Aussengewinde  
*adaptor piece M18 x 1.5 female thread  
 to Hirt-Line type2 male thread*

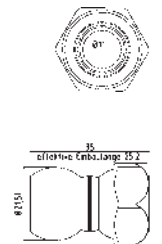

### 2-AD-LL

Adapterstück Loc-Line Typ 2  
*adaptor piece Loc-Line Type 2*

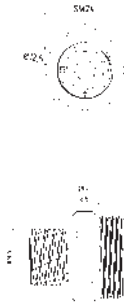

### 2-AD-RSV-38

Adapterstück mit Rückschlagventil G3/8"  
*adapter piece with check valve G3/8"*

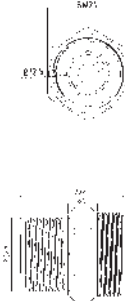

### 2-AD-RSV-12

Adapterstück mit Rückschlagventil G1/2"  
*adapter piece with check valve G1/2"*

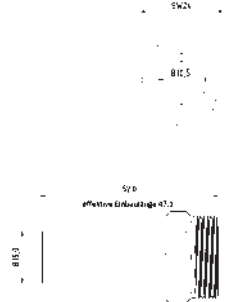

### 2-AD-15L

Adapterstück zu Hydraulik-Verschraubung 15 L  
*adaptor piece to hydraulic system 15 L*

## Winkelelemente | Elbows

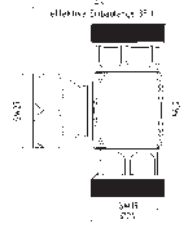
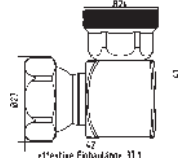
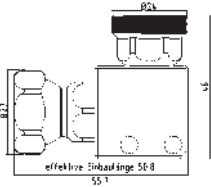
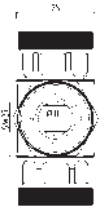
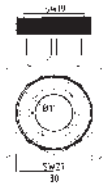

### 2-WI

Winkelstück für Leitungen mit 2 Bohrungen  
*corner piece for pipelines with 2 bore hole*

### 2-WV-1K

Winkelstück  
*elbow piece*

### 2-WV-2K

T-Stück  
*T-piece*

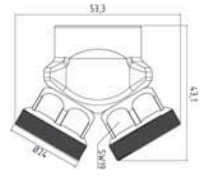
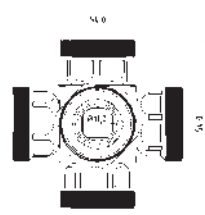
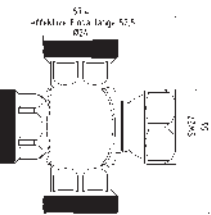
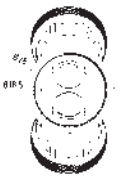
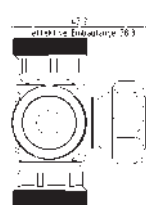
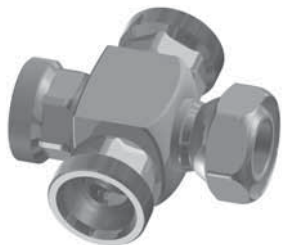

### 2-WV-3K

Kreuz-Stück  
*cross piece*

### 2-WV-4K

Stern-Stück  
*star piece*

### 2-YV

Y-Stück 50°  
*Y-piece 50°*

## Düsen | Nozzles

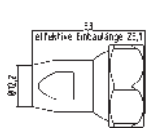
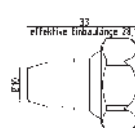
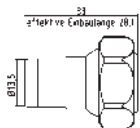
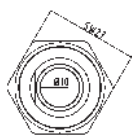
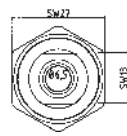
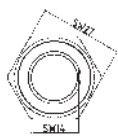

### 2-DU-0

Düse ohne Bohrung (für Spezialanwendungen)  
*nozzle without hole (for special applications)*

### 2-DU-65

Düse gerade Bohrung Ø 6,5 mm  
*nozzle straight Ø 6,5 mm*

### 2-DU-10

Düse gerade Bohrung Ø 10 mm  
*nozzle straight Ø 10 mm*



Düsen | Nozzles

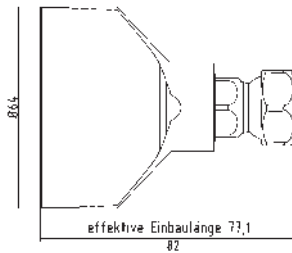

**2-DU-SL-65-GS**

Flachdüse Schlitzbreite 58 x 2,0 mm  
gerader Strahl  
*flat nozzle broadly with slit 58 x 2,0 mm  
straight jet*

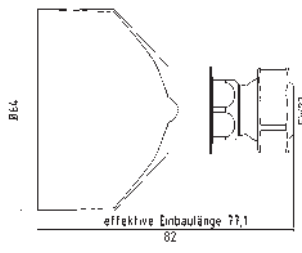

**2-DU-SL-65-GS-0.4**

Flachdüse Schlitzbreite 58 x 0,4 mm  
gerader Strahl  
*flat nozzle broadly with slit 58 x 0,4 mm  
straight jet*

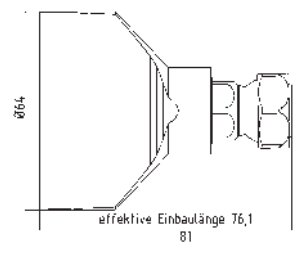
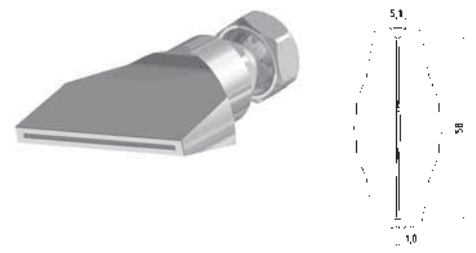

**2-DU-SL-65-GS-1.0**

Flachdüse Schlitzbreite 58 x 1,0 mm  
gerader Strahl  
*flat nozzle broadly with slit 58 x 1,0 mm  
straight jet*

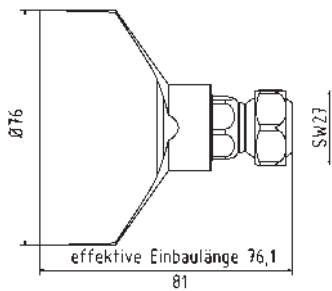
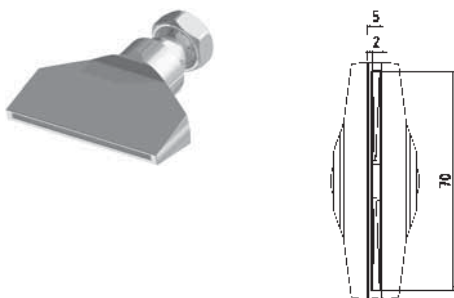

**2-DU-SL-76-GS**

Flachdüse Schlitzbreite 70 x 2,0 mm  
gerader Strahl  
*flat nozzle broadly with slit 70 x 2,0 mm  
straight jet*

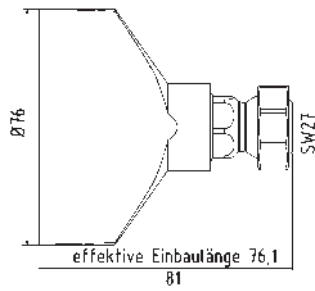
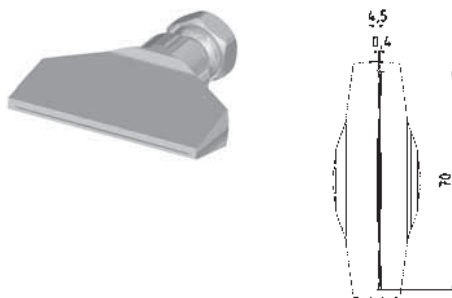

**2-DU-SL-76-GS-0.4**

Flachdüse Schlitzbreite 70 x 0,4 mm  
gerader Strahl  
*flat nozzle broadly with slit 70 x 0,4 mm  
straight jet*

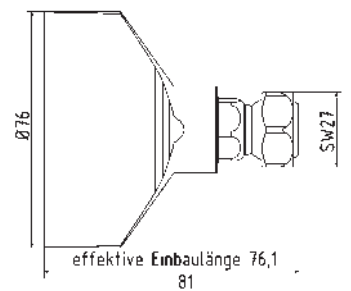
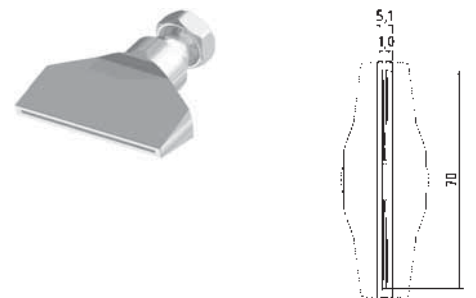

**2-DU-SL-76-GS-1.0**

Flachdüse Schlitzbreite 70 x 1,0 mm  
gerader Strahl  
*flat nozzle broadly with slit 70 x 1,0 mm  
straight jet*

# Type2 [1/2" System]

## Düsen | Nozzles

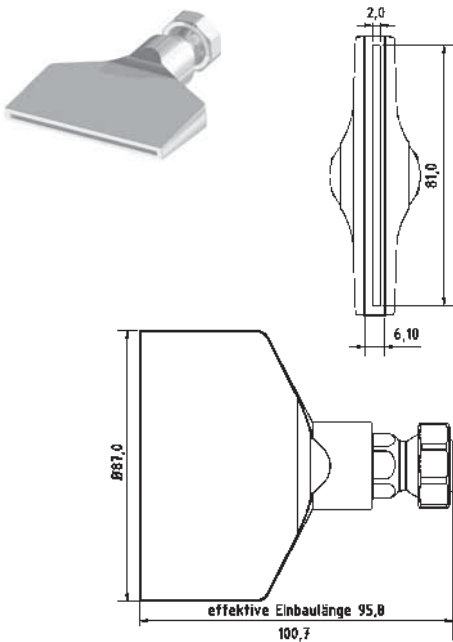

### 2-DU-SL-87-GS

Flachdüse Schlitzbreite 81 x 2,0 mm  
gerader Strahl  
*flat nozzle broadly with slit 81 x 2,0 mm  
straight jet*

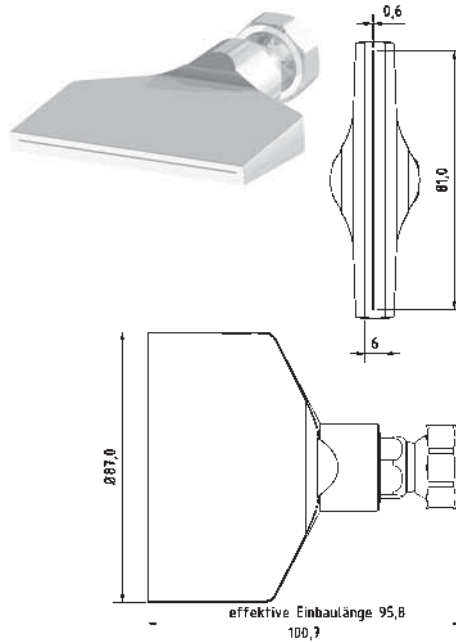

### 2-DU-SL-87-GS-0.6

Flachdüse Schlitzbreite 81 x 0,6 mm  
gerader Strahl  
*flat nozzle broadly with slit 81 x 0,6 mm  
straight jet*

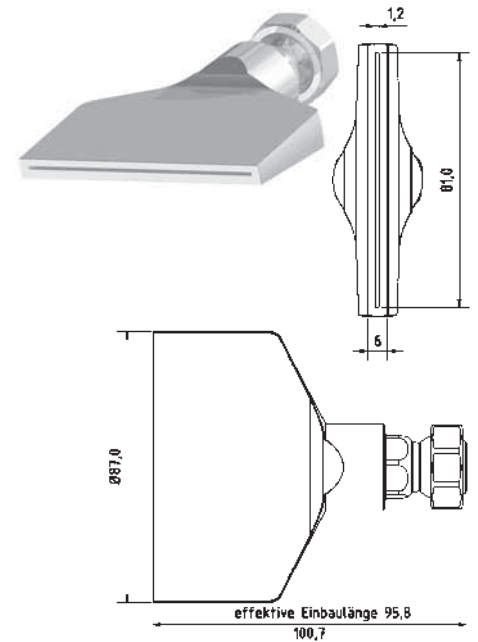

### 2-DU-SL-87-GS-1.2

Flachdüse Schlitzbreite 81 x 1,2 mm  
gerader Strahl  
*flat nozzle broadly with slit 81 x 1,2 mm  
straight jet*

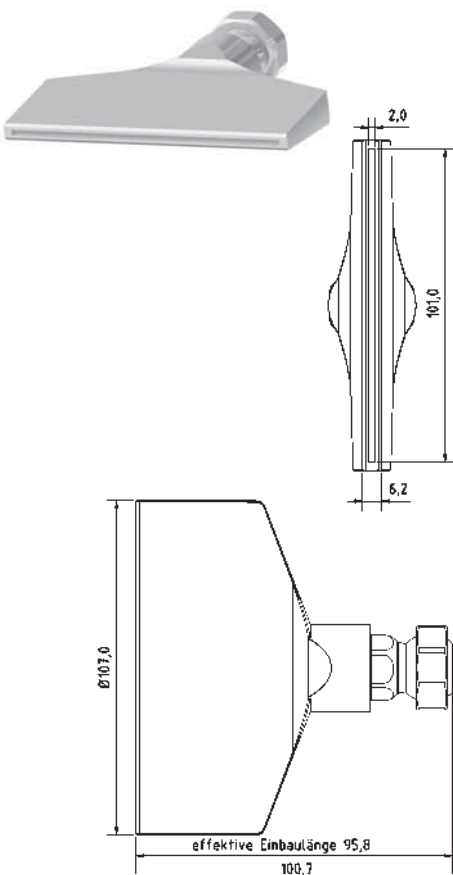

### 2-DU-SL-107-GS

Flachdüse Schlitzbreite 101 x 2,0 mm  
gerader Strahl  
*flat nozzle broadly with slit 101 x 2,0 mm  
straight jet*

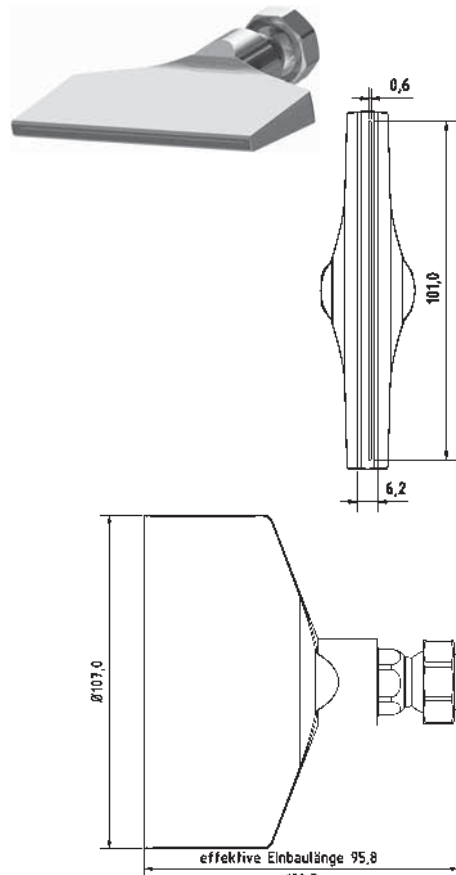

### 2-DU-SL-107-GS-0.6

Flachdüse Schlitzbreite 101 x 0,6 mm  
gerader Strahl  
*flat nozzle broadly with slit 101 x 0,6 mm  
straight jet*

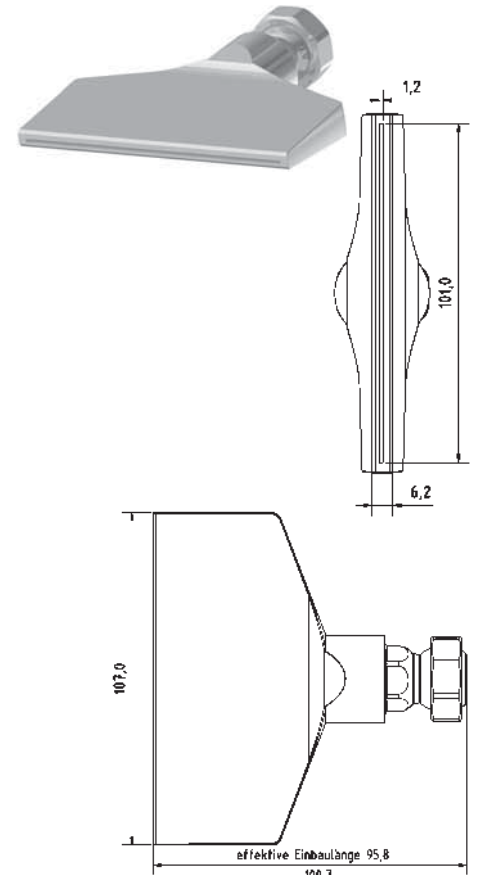

### 2-DU-SL-107-GS-1.2

Flachdüse Schlitzbreite 101 x 1,2 mm  
gerader Strahl  
*flat nozzle broadly with slit 101 x 1,2 mm  
straight jet*

**Düsen | Nozzles**

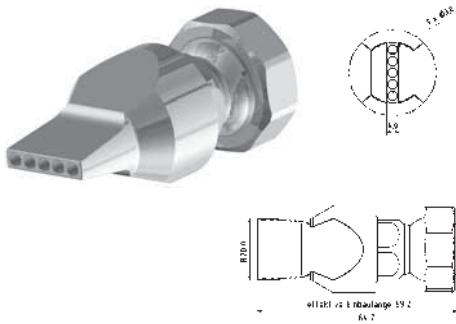

**2-DU-LL-5-3**

Düse gerade Bohrungen 5 x Ø 3 mm  
nozzle straight drill holes 5 x Ø 3 mm

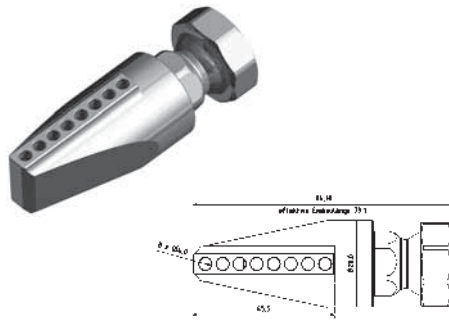

**2-DU-LL-90-8**

Düse 90° Bohrungen 8 x Ø 4 mm  
nozzle 90° drill holes 8 x Ø 4 mm

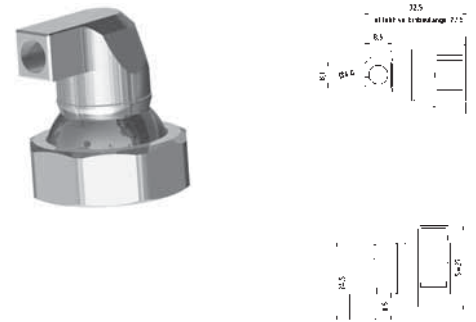

**2-DU-LL-90-1-6**

Düse 90° Bohrung 1 x Ø 6 mm  
nozzle 90° drill hole 1 x Ø 6 mm

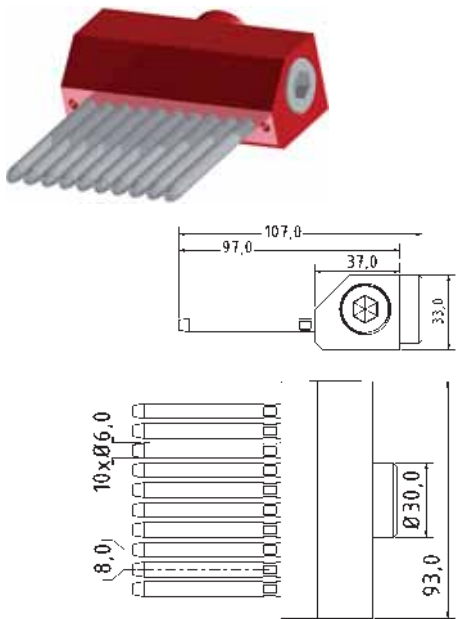

**2-NA-DU-96**

Modulare Nadeldüse l = 96mm  
inkl. 10 Nadeln nach Wahl l = 40-80mm  
Modular Needle nozzle l = 96mm  
incl. 10 needles of choice l = 40-80mm

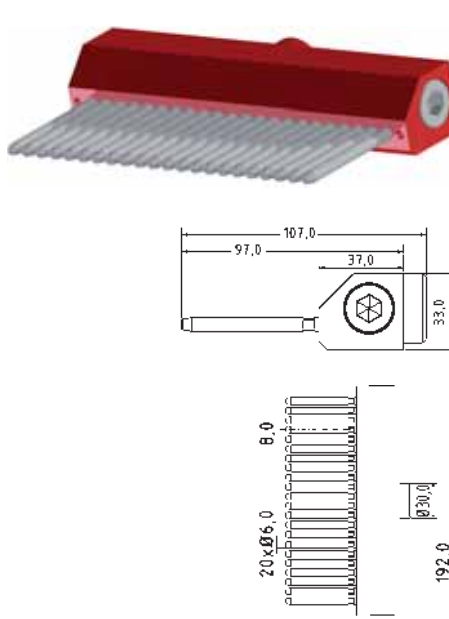

**2-NA-DU-192**

Modulare Nadeldüse = 192mm  
inkl. 22 Nadeln nach Wahl l = 40-80mm  
Modular Needle nozzle l = 192mm  
incl. 22 needles of choice l = 40-80mm

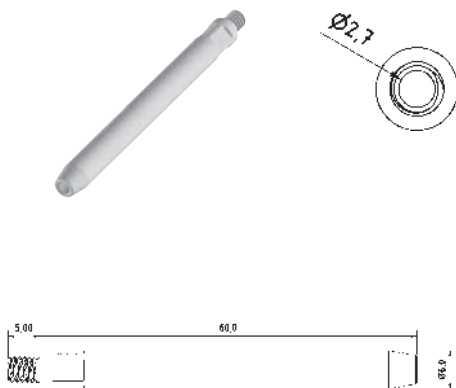

**2-NA-Nadel**

Einzeldüseninsert / Ersatznadel  
l = 40/50/60/70/80mm  
single nozzle insert / spare needle  
l = 40/50/60/70/80mm



**2-NA-ANB-SET**

Anbauset zum beliebig verlängern der Nadeldüsen  
attachment set for extending the needle nozzles as required

# Type2 [1/2" System]

## Kunststoff-Düsen | Plastic Nozzles

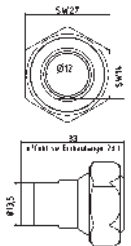
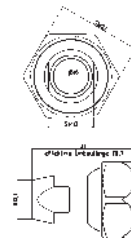
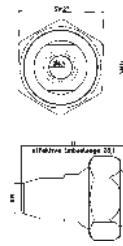

### KU-2-DU-65

Kunststoff-Düse gerade Bohrung  $\varnothing$  6,5 mm  
plastic nozzle straight  $\varnothing$  6,5 mm

### KU-2-DU-10

Kunststoff-Düse gerade Bohrung  $\varnothing$  10 mm  
plastic nozzle straight  $\varnothing$  10 mm

### KU-2-DU-12

Kunststoff-Düse gerade Bohrung  $\varnothing$  12 mm  
plastic nozzle straight  $\varnothing$  12 mm

## Zubehör | Accessories

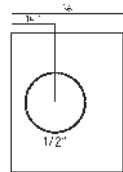

### VB-3-38

Verteilerblock Eingang Stirnseite G1/2"  
manifold block entrance front end 1/2"

### VB-3-38-PT

Verteilerblock Eingang Stirnseite G1/2" PT  
manifold block entrance front end 1/2" NPT

### VB-3-38-BS

Blindstopfen G3/8"  
blank plug with thread 3/8"

### VB-3-38-PT-BS

Blindstopfen mit G3/8" PT Gewinde  
blank plug with thread 3/8" NPT

### 2-FP

Zwischenelement mit fester Position  
(Schnellkupplung)  
Intermediate element with fixed position  
(quick coupling)

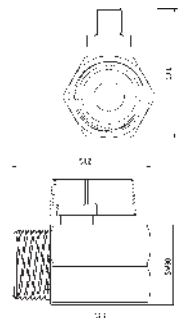
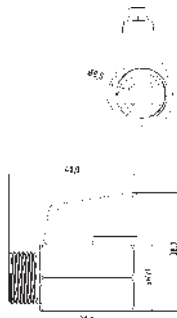

### KH-38

Mini-Kugelhahn G3/8" Messing Verchromt  
mini ball valve thread 3/8" brass chrome-plated

### KH-38-SS

Mini-Kugelhahn G3/8" Edelstahl  
mini ball valve thread 3/8" stainless steel

### KH-12

Mini-Kugelhahn G1/2" Messing Verchromt  
mini ball valve thread 1/2" brass chrome-plated

### KH-12-SS

Mini-Kugelhahn G1/2" Edelstahl  
mini ball valve thread 1/2" stainless steel

### KH-34

Mini-Kugelhahn G3/4" Messing Verchromt  
mini ball valve thread 3/4"

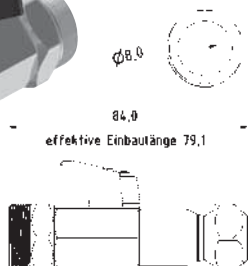
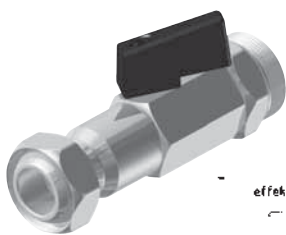

### 2-KH-Z

Kugelhahn Zwischenelement Typ2  
ball valve intermediate element type2

**Zubehör | Accessories**

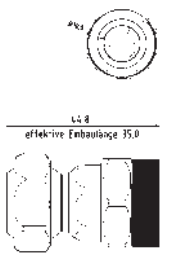
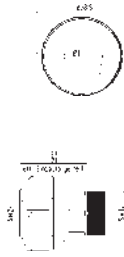

**RE-2-1**  
Reduktion Typ 2 auf Typ 1  
*reduction Type 2 to Type 1*

**RE-2-G1/4**  
Reduktion Typ 2 auf G 1/4"  
*reduction Type 2 to G 1/4"*

**2-RSV**  
Rückschlagventil (Drop-Stop)  
*Check valve (Drop-Stop)*

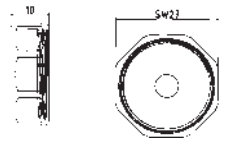
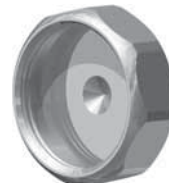
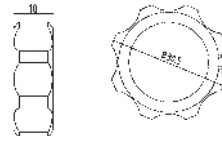
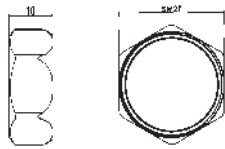

**2-MU**  
Mutter Standard  
*screw nut (default)*

**2-MU-HA**  
Mutter für Handverstellung  
*screw nut (hand feed)*

**2-VK**  
Verschlusskappe Typ 2  
*cap type 2*

**Grundset | Basic Set**



**SW-19**  
Schlüssel aus Stahl SW19  
*open end wrench SW19*



**SW-27**  
Schlüssel aus Stahl SW27  
*open end wrench SW27*

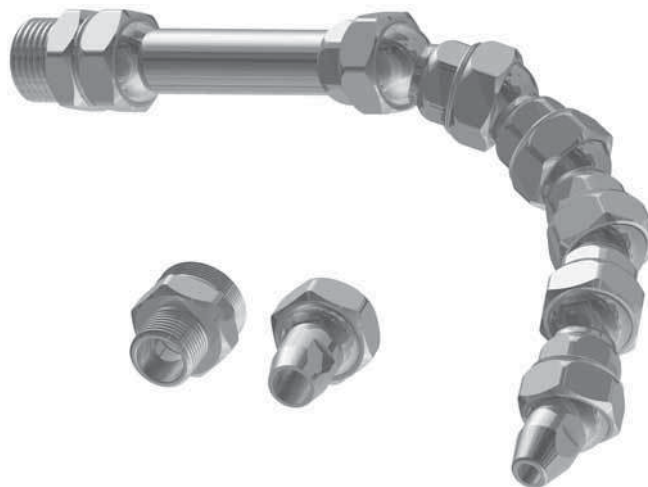

**2-GS**  
Grundset Typ2 1/2" System L = 240 mm  
5 x 2-GE, 1 x 2-GE-3, 1 x 2-AD-38, 1 x 2-AD-12, 1 x 2-DU-65 1 x 2-DU-10, 1 x SW-19, 1 x SW-27  
*basic set Type2 1/2" system l = 240 mm*  
5 x 2-GE, 1 x 2-GE-3, 1 x 2-AD-38, 1 x 2-AD-12, 1 x 2-DU-65 1 x 2-DU-10, 1 x SW-19, 1 x SW-27



## PRODUCT OVERVIEW

### Type3 [3/4"]



The system type 3 or also called 3/4" promises the suitable stability for your machines besides the proven and reliable quality. The 19 mm diameter diffuser provides the required litre capacity (over 200 l/min) precisely and stably (up to 60 bar) from the pump to the tool. Suitable in this system there are currently 25 different nozzles, from simple round nozzles from Ø12 mm, Ø15 mm and Ø19 mm up to the largest flat nozzle 101 mm x 2 mm which are also optimized for the grinding process. All nozzles are manufactured with high

precision and can be easily replaced for any application. With the 3/8", 3/4" and 1" adapters, it is easy to install this system on any machine. As usual, there are various basic and angular elements which allow the system to be configured flexibly and as required. Optionally a ball valve and further accessories can be acquired

# Type3 [3/4" System]

**TECHNICAL SPECIFICATIONS:**

- Size Type3 (3/4")
- Passage Ø19,0 mm
- Pressure resistant up to 60 bar
- Application range -30°C to +60°C
- Optional ES-System up to +300°C (available on request)
- Thread (Elements) M34x1,25
- Material 1.4305 (V2A)

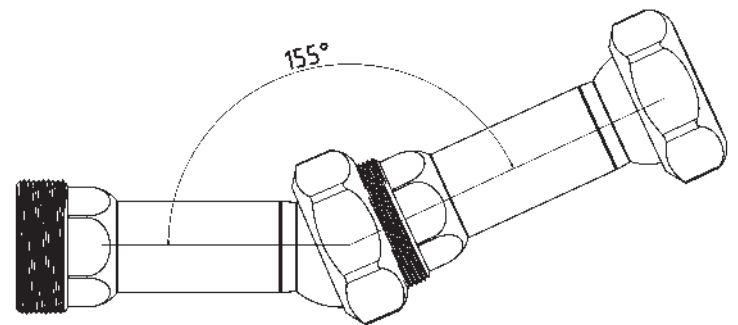
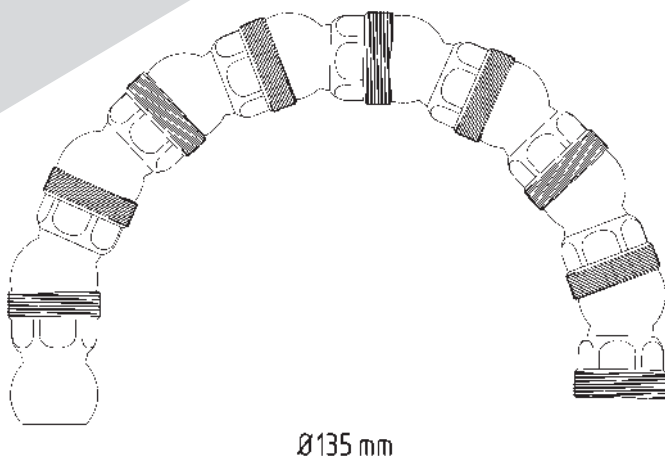

MACHINE ADAPTER



BASIC ELEMENTS



NOZZLES

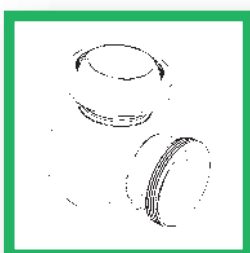

ELBOWS



ACCESSORIES



BASIC SET Type3

# Type3 [3/4" System]

## Grundelemente | Basic Elements

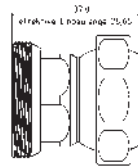

### 3-GE

$l = 37$  mm effektiv  $l = 28,6$  mm  
 $l = 37$  mm effective  $l = 28,6$  mm

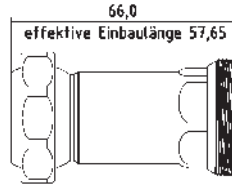

### 3-GE-2

$l = 66$  mm effektiv  $l = 57,6$  mm  
 $l = 66$  mm effective  $l = 57,6$  mm

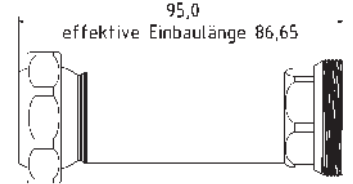
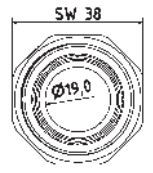

### 3-GE-3

$l = 95$  mm effektiv  $l = 86,6$  mm  
 $l = 95$  mm effective  $l = 86,6$  mm



### 3-GE-DK Special element

Grundelement  $l \times 40$  mm effektiv  $l \times 23,3$  mm  
 basic element  $l \times 40$  mm effective  $l \times 23,3$  mm

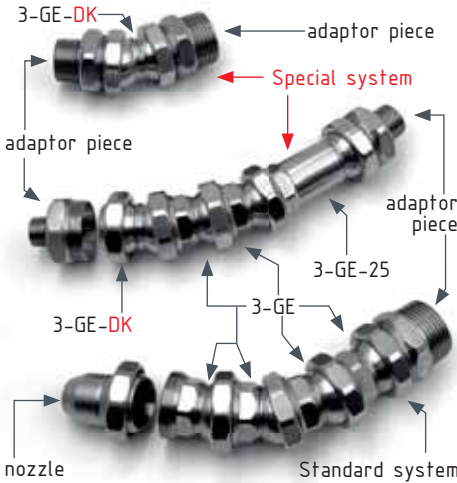

## Maschinen-/Düsenadapter | Machine-/Nozzle Adapter

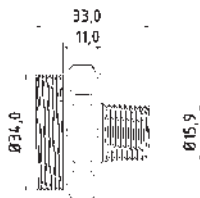
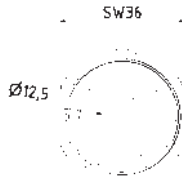

### 3-AD-38-PT

Adapterstück G 3/8" PT (Withworth-Gewinde)  
 adaptor piece thread 3/8" PT (NPT thread)

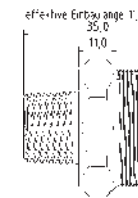
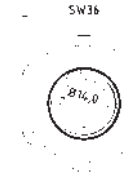

### 3-AD-12-PT

Adapterstück G 1/2" PT (Withworth-Gewinde)  
 adaptor piece thread 1/2" PT (NPT thread)

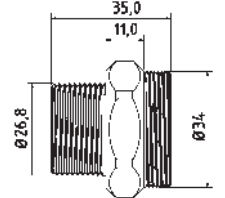
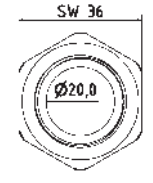

### 3-AD-34-PT

Adapterstück G 3/4" PT (Withworth-Gewinde)  
 adaptor piece thread 3/4" PT (NPT thread)

## Maschinen-/Düsenadapter | Machine-/Nozzle Adapter

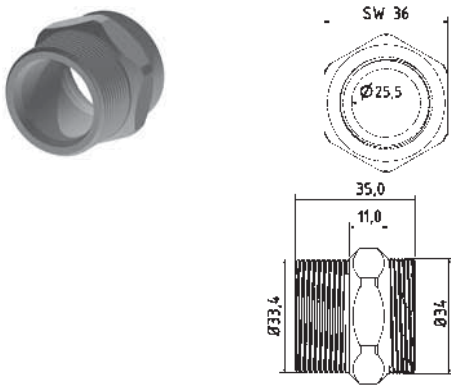

**3-AD-10-PT**  
Adapterstück G 1" PT (Withworth-Gewinde)  
*adaptor piece thread G 1" PT (NPT thread)*

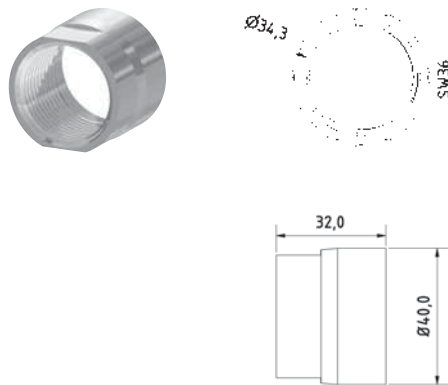

**3-AD-3GE-1**  
Adapterstück für Fremddüsen mit  
Außengewinde, IG 3-GE auf IG 1"  
*adapter piece for external nozzles with male  
thread, female 3-GE to female 1"*

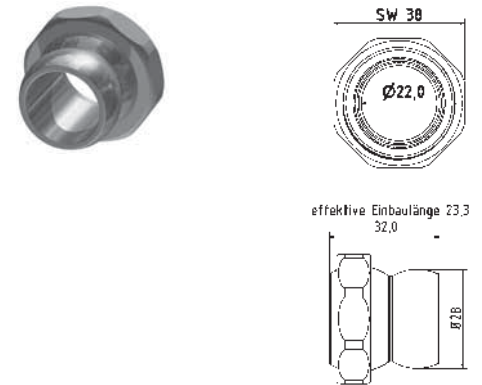

**3-AD-LL**  
Adapterstück Loc-Line Typ 3  
*adaptor piece Loc-Line Type 3*

## Winkелеlemente | Elbows

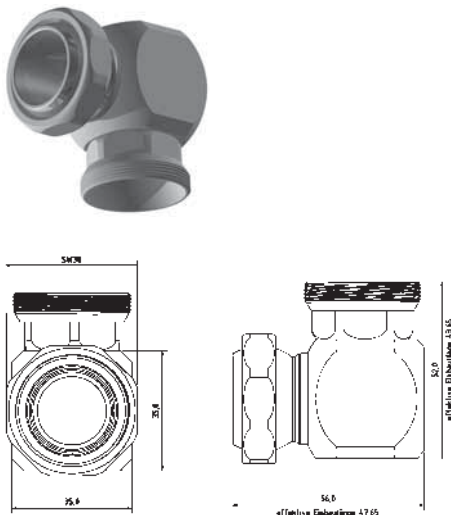

**3-WV-1K**  
Winkelverschraubung mit Kugelstück  
*elbow piece movable*

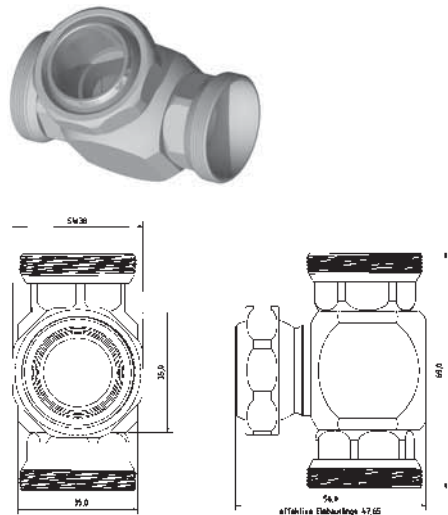

**3-WV-2K**  
T-Stück mit Kugelstück  
*T-piece movable*

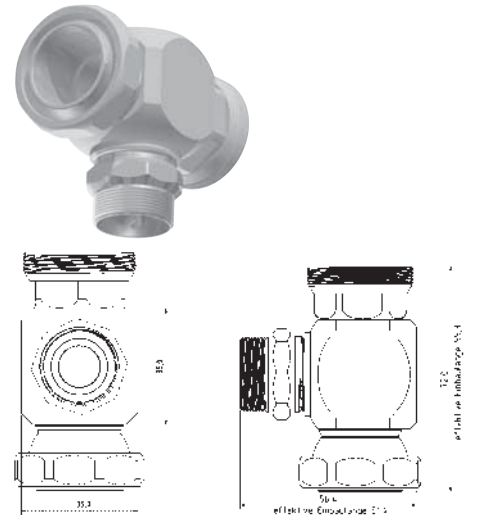

**3-WV-R-2K**  
T-Stück für Ring und Düse  
*T-piece fo ring and nozzle*

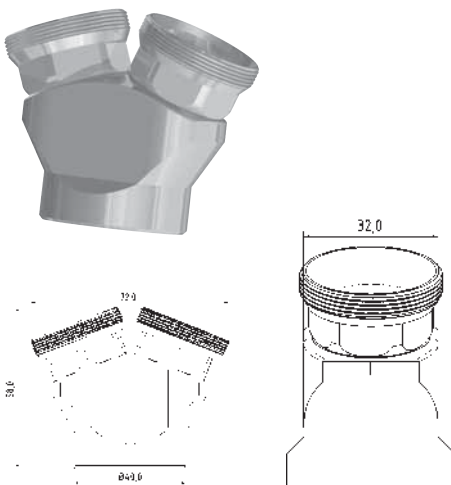

**3-YV**  
Y-Stück 50°  
*Y-piece 50°*

# Type3 [3/4" System]

## Düsen | Nozzles

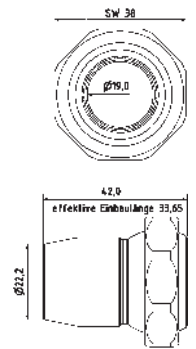
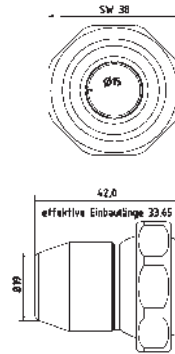
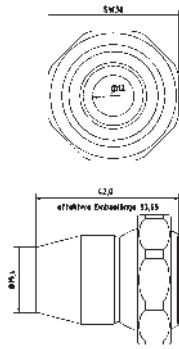

### 3-DU-12

Düse gerade Bohrung Ø 12 mm  
nozzle straight Ø 12 mm

### 3-DU-15

Düse gerade Bohrung Ø 15 mm  
nozzle straight Ø 15 mm

### 3-DU-19

Düse gerade Bohrung Ø 19 mm  
nozzle straight Ø 19 mm

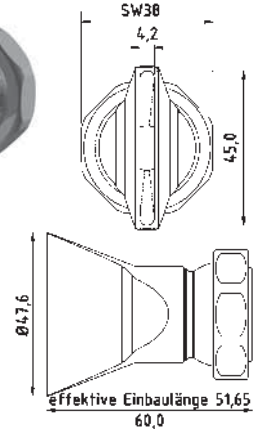
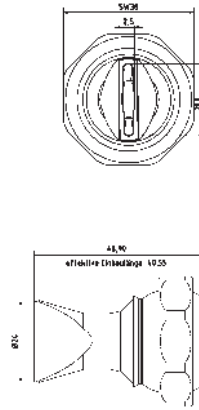
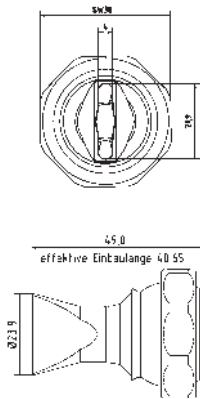

### 3-DU-SL-25

Flachdüse Schlitzbreite 22 x 4,0 mm  
Streustrahl  
flat nozzle broadly with slit 22 x 4,0 mm  
scattered beam

### 3-DU-SL-25-SS

Flachdüse Schlitzbreite 20 x 2,5 mm  
Streustrahl  
flat nozzle broadly with slit 20 x 2,5 mm  
scattered beam

### 3-DU-SL-50

Flachdüse Schlitzbreite 45 x 4,2 mm  
Streustrahl  
flat nozzle broadly with slit 45 x 4,2 mm  
scattered beam

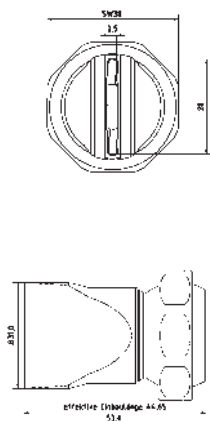
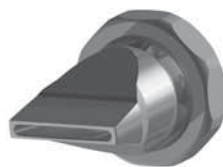
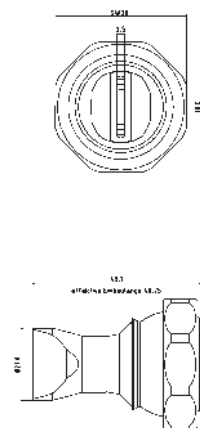

### 3-DU-SL-25-GS

Flachdüse Schlitzbreite 18 x 2,5 mm  
gerader Strahl  
flat nozzle broadly with slit 18 x 2,5 mm  
straight jet

### 3-DU-SL-31-GS

Flachdüse Schlitzbreite 28 x 2,5 mm  
gerader Strahl  
flat nozzle broadly with slit 28 x 2,5 mm  
straight jet

## Düsen | Nozzles

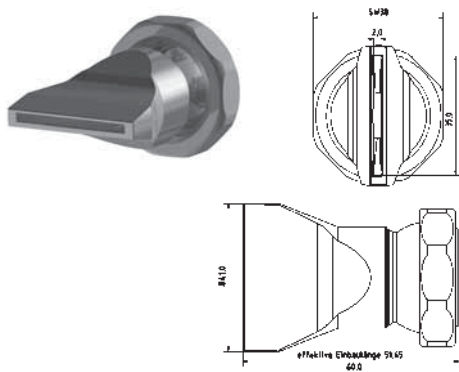

### 3-DU-SL-50-GS

Flachdüse Schlitzbreite 35 x 2,0 mm  
gerader Strahl  
*flat nozzle broadly with slit 35 x 2,0 mm*  
*straight jet*

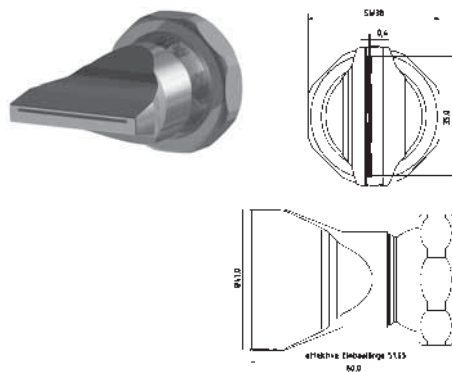

### 3-DU-SL-50-GS-0.4

Flachdüse Schlitzbreite 35 x 0,4 mm  
gerader Strahl  
*flat nozzle broadly with slit 35 x 0,4 mm*  
*straight jet*

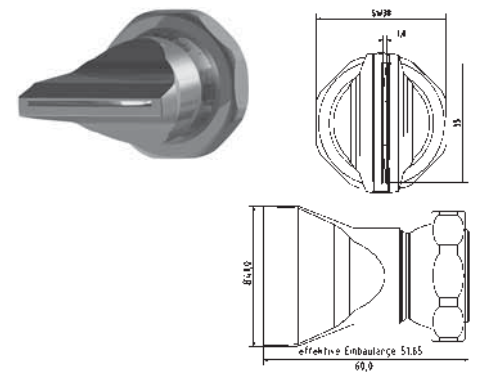

### 3-DU-SL-50-GS-1.0

Flachdüse Schlitzbreite 35 x 1,0 mm  
gerader Strahl  
*flat nozzle broadly with slit 35 x 1,0 mm*  
*straight jet*

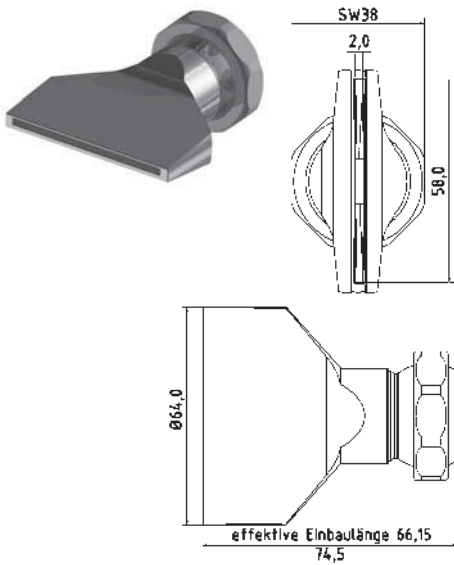

### 3-DU-SL-65-GS

Flachdüse Schlitzbreite 58 x 2,0 mm  
gerader Strahl  
*flat nozzle broadly with slit 58 x 2,0 mm*  
*straight jet*

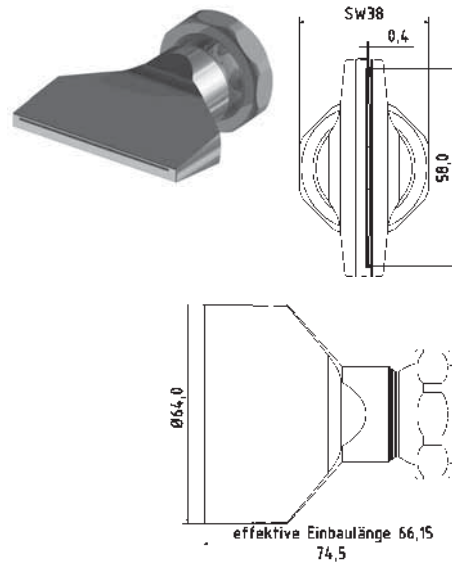

### 3-DU-SL-65-GS-0.4

Flachdüse Schlitzbreite 58 x 0,4 mm  
gerader Strahl  
*flat nozzle broadly with slit 58 x 0,4 mm*  
*straight jet*

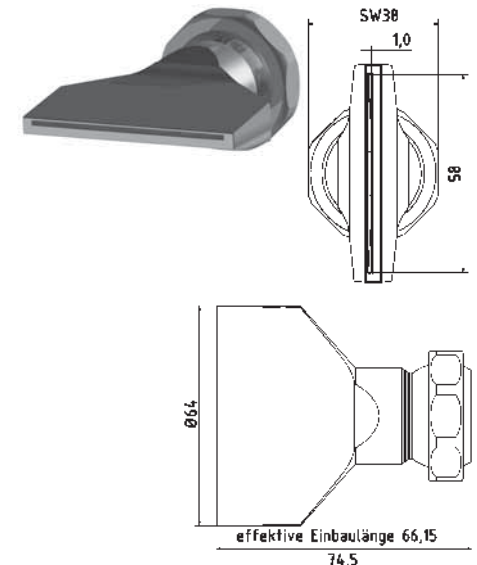

### 3-DU-SL-65-GS-1.0

Flachdüse Schlitzbreite 58 x 1,0 mm  
gerader Strahl  
*flat nozzle broadly with slit 58 x 1,0 mm*  
*straight jet*

# Type3 [3/4" System]

## Düsen | Nozzles

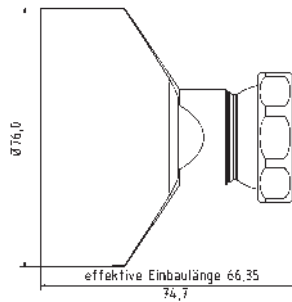
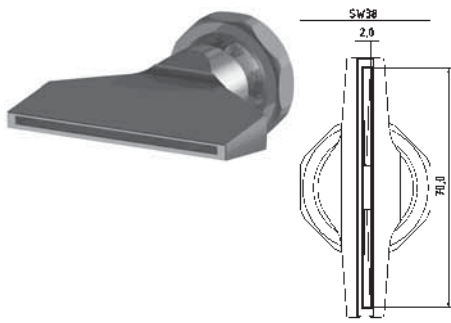

### 3-DU-SL-76-GS

Flachdüse Schlitzbreite 70 x 2,0 mm  
gerader Strahl  
*flat nozzle broadly with slit 70 x 2,0 mm  
straight jet*

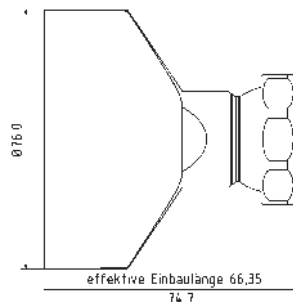
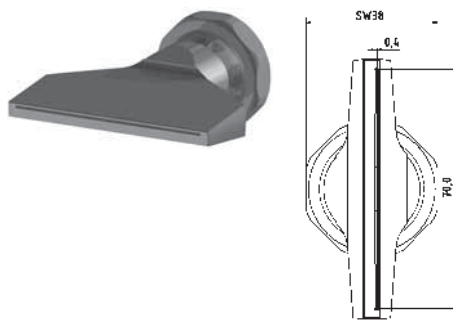

### 3-DU-SL-76-GS-0.4

Flachdüse Schlitzbreite 70 x 0,4 mm  
gerader Strahl  
*flat nozzle broadly with slit 70 x 0,4 mm  
straight jet*

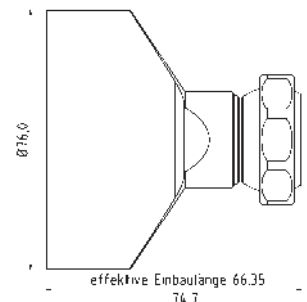
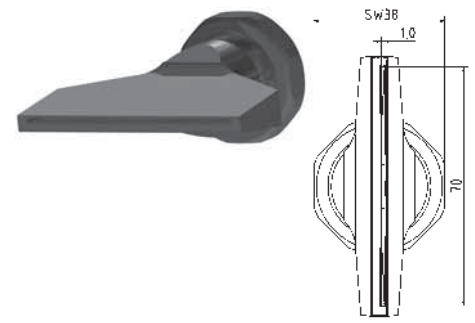

### 3-DU-SL-76-GS-1.0

Flachdüse Schlitzbreite 70 x 1,0 mm  
gerader Strahl  
*flat nozzle broadly with slit 70 x 1,0 mm  
straight jet*

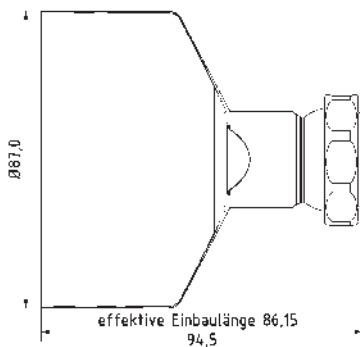
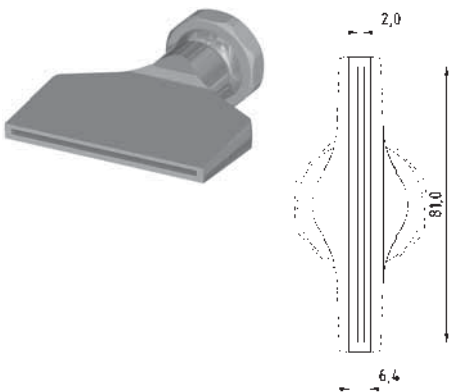

### 3-DU-SL-87-GS

Flachdüse Schlitzbreite 81 x 2,0 mm  
gerader Strahl  
*flat nozzle broadly with slit 81 x 2,0 mm  
straight jet*

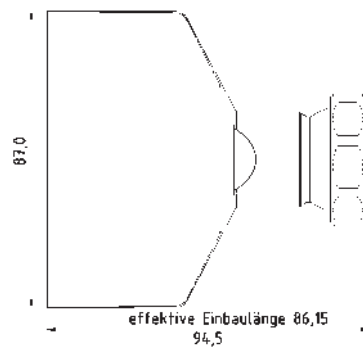
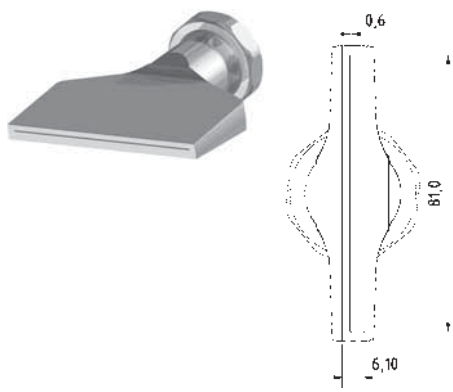

### 3-DU-SL-87-GS-0.6

Flachdüse Schlitzbreite 81 x 0,6 mm  
gerader Strahl  
*flat nozzle broadly with slit 81 x 0,6 mm  
straight jet*

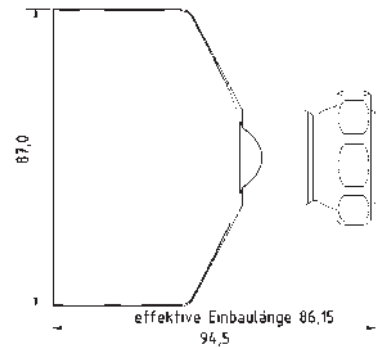
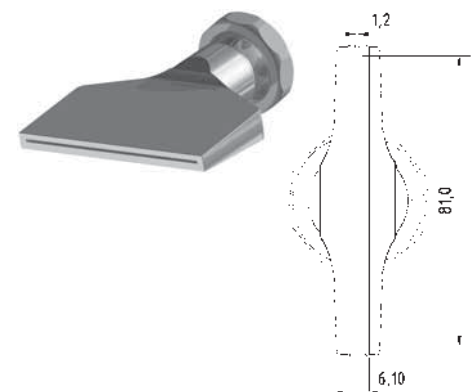

### 3-DU-SL-87-GS-1.2

Flachdüse Schlitzbreite 81 x 1,2 mm  
gerader Strahl  
*flat nozzle broadly with slit 81 x 1.2 mm  
straight jet*

Düsen | Nozzles

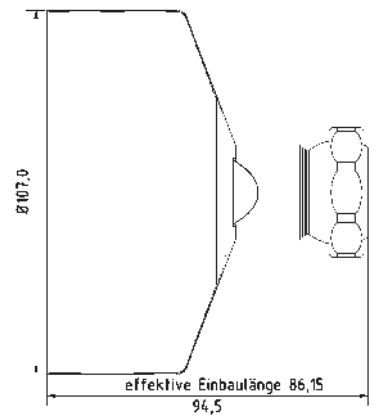
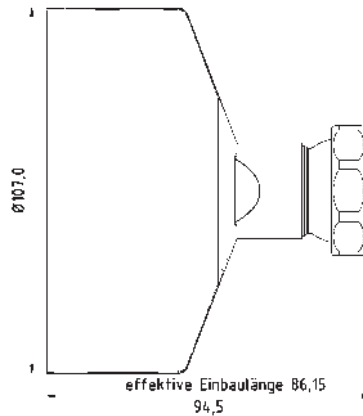
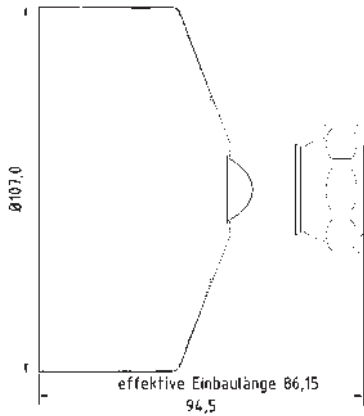
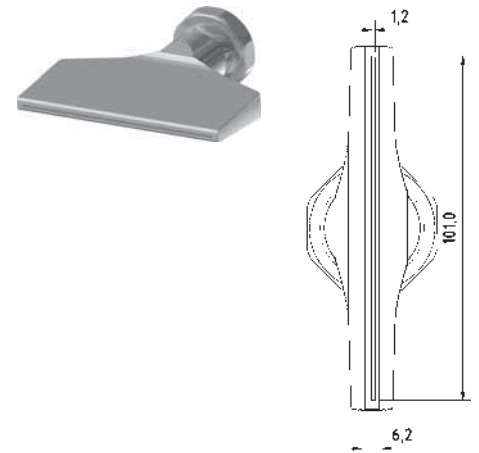
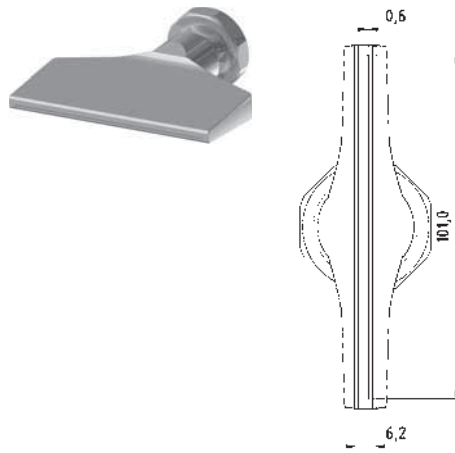
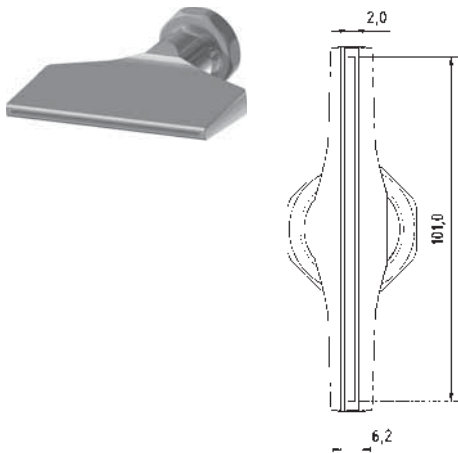

**3-DU-SL-107-GS**

Flachdüse Schlitzbreite 101 x 2,0 mm  
gerader Strahl  
*flat nozzle broadly with slit 101 x 2,0 mm  
straight jet*

**3-DU-SL-107-GS-0.6**

Flachdüse Schlitzbreite 101 x 0,6 mm  
gerader Strahl  
*flat nozzle broadly with slit 101 x 0,6 mm  
straight jet*

**3-DU-SL-107-GS-1.2**

Flachdüse Schlitzbreite 101 x 1,2 mm  
gerader Strahl  
*flat nozzle broadly with slit 101 x 1,2 mm  
straight jet*

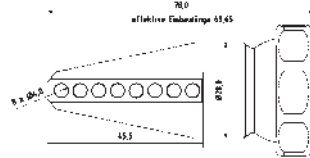
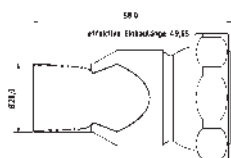
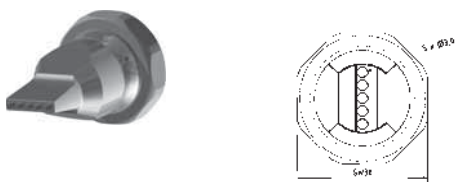

**3-DU-LL-5-3**

Düse gerade mit Bohrungen 5 x Ø 3 mm  
*nozzle straight with holes 5 x Ø 3 mm*

**3-DU-LL-90-8**

Düse 90° mit Bohrungen 8 x Ø 4 mm  
*nozzle 90° with holes 8 x Ø 4 mm*



# Type3 [3/4" System]

## Zubehör | Accessories



### KH-38

Mini-Kugelhahn G3/8" Messing Verchromt  
mini ball valve thread 3/8" brass chrome-plated

### KH-38-SS

Mini-Kugelhahn G3/8" Edelstahl  
mini ball valve thread 3/8" stainless steel



### KH-12

Mini-Kugelhahn G1/2" Messing Verchromt  
mini ball valve thread 1/2" brass chrome-plated

### KH-12-SS

Mini-Kugelhahn G1/2" Edelstahl  
mini ball valve thread 1/2" stainless steel

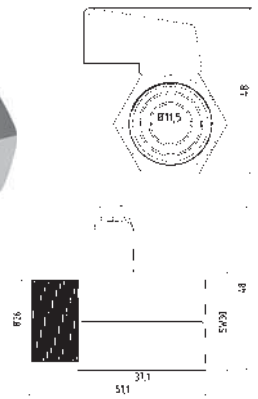

### KH-34

Mini-Kugelhahn G3/4" Messing Verchromt  
mini ball valve thread 3/4" brass chrome-plated



### 3-SW-27

Schlüssel aus Stahl SW 27  
open end wrench SW 27



### 3-SW-38

Schlüssel aus Stahl SW 38  
open end wrench SW 38

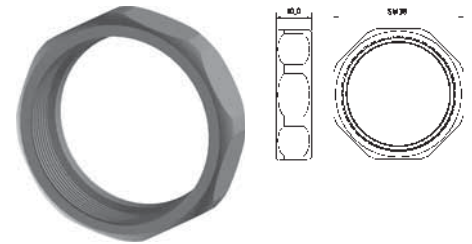

### 3-MU

Mutter Standard  
screw nut (default)

## Grundset | Basic Set

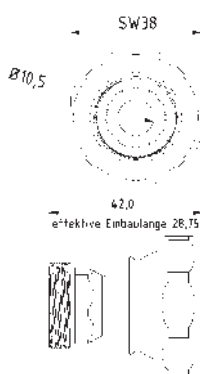

### RE-3-2

Reduktion Typ 3 auf Typ 2  
reduction Type 3 to Type 2

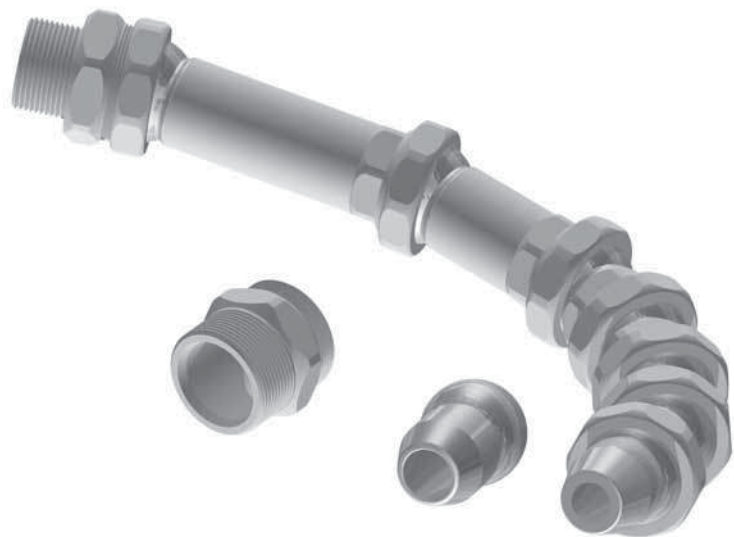

### 3-GS

Grundset Typ3 3/4" Zoll System L = 320 mm  
basic set Type3 3/4" system l = 320 mm  
4 x 3-GE, 1 x 3-GE-2, 1 x 3-GE-3, 1 x 3-AD-34PT, 1 x 3-AD-10PT, 1 x 3-DU-12,  
1 x 3-DU-15, 1 x 3-SW-27, 1 x 3-SW-38

INNOVATIVE NOZZLES  
FOR TOP PERFORMANCE



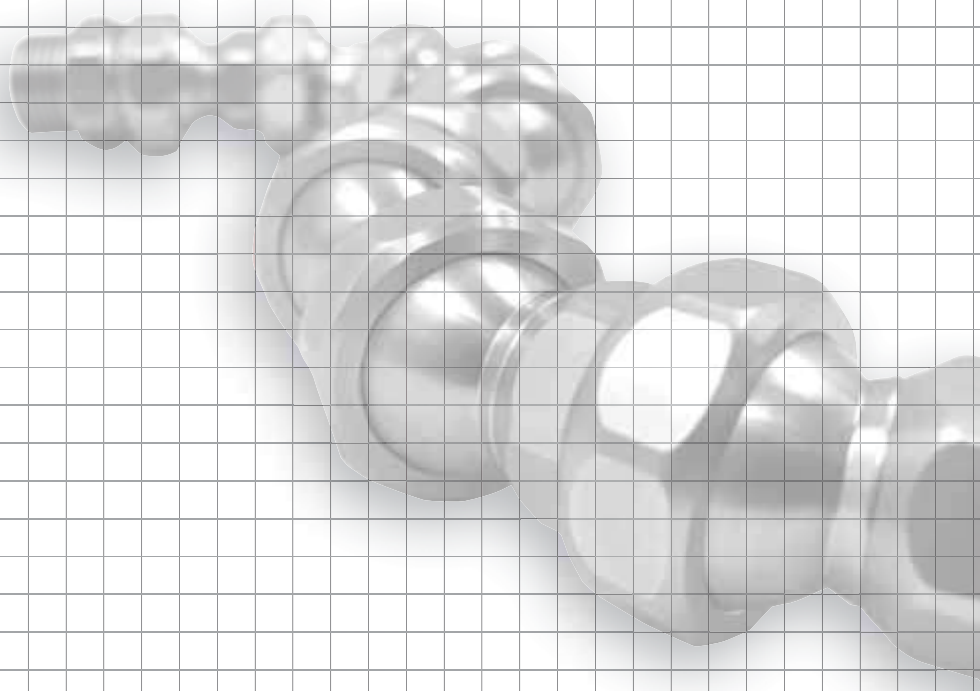

FAST AND

POWERFUL

SUPPORT

We will advise you personally  
about the benefits of our  
Cooling-Lubricant-Supply Systems

**Hirt**<sup>®</sup>  
**LINE**

[www.kuehlmittelschlauch.com](http://www.kuehlmittelschlauch.com)

**Hirt-Line Europe**

Seestr. 16  
CH-8268 Salenstein

PH.: +41 71 53 43 959  
Fax: +41 71 53 43 953

[info@hirt-line-europe.com](mailto:info@hirt-line-europe.com)

Abbildungen können vom Original abweichen. Änderungen der technischen Daten jederzeit ohne Vorankündigung vorbehalten. Jede Nachbildung des Produktes, gleich ob ganz oder teilweise, sowie der zugehörigen Technologien ist untersagt. Hirt-Line® ist ein registrierter Name. Technische Änderungen und Irrtümer vorbehalten.  
All illustrations are for reference only. The technical datas are subject to change. A copy of the product, whether in whole or in part, and the related technologies is prohibited.  
Hirt-Line® is a registered name. Technical amendmends and errors may occur.