



GEA Tuchenhagen Hygienic Valves VARIVENT® and ECOVENT®
Business Line Hygienic Valve Technology

Catalog 2015

Legal notice

Publication date: May 2015

The publication of specifications, technical data and information in written or electronic form does not release the user from the responsibility of checking for themselves all products delivered by us for suitability for the application(s) intended. These may be subject to change without prior notification. Errors and printing errors excepted – we assume no liability for the correctness of specifications given.

The general terms and conditions of delivery apply.

All rights reserved – copyright on all contents

GEA Tuchenhagen GmbH
Am Industriepark 2–10, 21514 Büchen, Germany
Registered office: Büchen, Court of Registration: Lübeck, HRB 836 SB
Management office: Dipl.-Kfm. Franz Bürmann
Sales tax identification number: DE 812589019

Business Unit GEA Flow Components	6
Hygienic Valves	
Introduction to hygienic valves	8
Overview	10
Technical data	12
Valve selection matrix	16
Shut-off Valves	
Overview of single-seat valves	18
Valve selection matrix	22
VARIVENT® type N	24
ECOVENT® type N/ECO	26
ECOVENT® type N/ECO small	28
VARIVENT® type N_V	30
VARIVENT® type U	32
VARIVENT® type U_V	34
Divert Valves	
Overview of single-seat valves	36
Valve selection matrix	40
VARIVENT® type W	42
ECOVENT® type W/ECO	44
ECOVENT® type W/ECO small	46
VARIVENT® type W_R	48
VARIVENT® type W_V	50
VARIVENT® type X	52
VARIVENT® type X_V	54
Mixproof Shut-off Valves	
Overview of double-seat valves	56
Valve selection matrix	60
VARIVENT® type D	62
VARIVENT® type B	64
VARIVENT® type R	66
VARIVENT® type D_V	68
VARIVENT® type L_H	70
VARIVENT® type L_S	72
Overview of valves for gas blocks and CIP systems	74
VARIVENT® type C	76
VARIVENT® type K	78
Mixproof Shut-off Valves with Seat Lifting	
Overview of double-seat valves	80
Valve selection matrix	84
VARIVENT® type D_L, D_C	86
VARIVENT® type B_L, B_C	88
VARIVENT® type R_L, R_C	90
VARIVENT® type D_L/V, D_C/V	92
VARIVENT® type L_HL, L_HC	94
VARIVENT® type L_SL, L_SC	96
Overview of 24/7 PMO Valve® 2.0	98
24/7 PMO Valve® type M/2.0	100

Mixproof Divert Valves

Overview of double-seat valves 102
 Valve selection matrix..... 106
 VARIVENT® type Y 108
 VARIVENT® type Y_L, Y_C 110

Tank Bottom Valves

Overview of single-seat bottom valves 112
 Valve selection matrix..... 116
 VARIVENT® type N 118
 ECOVENT® type N/ECO 120
 VARIVENT® type N_V 122
 VARIVENT® type U..... 124
 VARIVENT® type U_V 126
 VARIVENT® type T_R 128
 VARIVENT® type T_RL, T_RC 130
 VARIVENT® type T_RC 132

Options

Available options 134
 Supplement to the valve type 137
 Housing and nominal widths 144
 Actuators..... 150
 Seal materials..... 158
 Surface qualities..... 159
 Connection fittings 161
 Accessories 166
 Additional options 176
 Actuator selection..... 182

Spare Parts

VARIVENT® valve inserts..... 205
 VARIVENT® housing combinations 206
 Seal kits 210
 Tools..... 218

Control and Feedback Systems

Overview 241
 Selection matrix T.VIS® 242
 T.VIS® M-15 244
 T.VIS® A-15 250
 T.VIS® P-15 254
 SES (ATEX)..... 258
 Connection 0, INA, LAT 262
 Proximity switches, adaption 264
 Logic NOT-element, IP protection classes 266
 LEFF® function and semi-automatic setup, connection screw fitting 268
 Interface types 270

Appendix

Composition of the order codes 272
 Total order codes 274
 Certificates 297
 Abbreviations and terms 295
 CAD files 299
 General sales terms and conditions of delivery 300
 Contact data of the Business Unit GEA Flow Components 304



Whether it's dairy, beer, viscous food ingredients or fine-chemical products – product quality and profitability are what matter in the end. This is precisely what the business unit GEA Flow Components stands for – a specialist with many years of experience for everything that flows.

The GEA Group

GEA Group Aktiengesellschaft is one of the largest suppliers of systems for the food processing industry. As an international technology group, the Company focuses on process technology and components for sophisticated production processes in a variety of markets.

The Business Unit GEA Flow Components

As a technology leader, the business unit GEA Flow Components develops and produces well-engineered process components and services for smooth production processes in the treatment of liquid products.

The business unit is comprised of GEA Tuchenhagen in Germany, GEA Aseptomag in Switzerland and GEA Breconcherry in Great Britain as well as further sites in France, Poland, China, India, Canada and the USA.



Four business lines – for everything that flows

The product range of the business unit GEA Flow Components includes hygienic and aseptic valve technology, hygienic pumps and cleaning technology. These products are used particularly for the brewing, beverages, dairy and food industries, as well as for the pharmaceutical, health care, biotechnology and fine-chemicals industries.

Hygienic valves and components from GEA Tuchenhagen form the core component of matrix-piped process plants. For aseptic processes, which require components with the highest levels of sterility, GEA Aseptomag produces aseptic valves and systems that meet specific requirements.

The hygienic pump range from GEA Tuchenhagen also belongs to the business unit's range of solutions. This includes non-self priming and self-priming centrifugal pumps, as well as rotary piston pumps. Rounding off this range of solutions, GEA Breconcherry offers cleaning technology especially developed for the sustainable conservation of valuable resources.

The business unit GEA Flow Components focuses on major process solutions for the food processing, pharmaceutical and biotechnology manufacturing industries with leading hygienic and aseptic valve technology, pumps and cleaning technology.



Hygienic Valve Technology

GEA Tuchenhagen



Hygienic Pump Technology

GEA Tuchenhagen



Cleaning Technology

GEA Breconcherry



Aseptic Valve Technology

GEA Aseptomag



GEA Tuchenhagen products are based on future-oriented company and product design principles that include an obligation to economic viability, sustainability and service.



Your investment pays off

GEA Tuchenhagen VARIVENT® and ECOVENT® hygienic valves help you to achieve considerable cost savings. The valve concepts with a variable structure and the efficient control technology provide both low purchase costs and low energy consumption.

The design of the valves and individual components without dead space satisfies the most exacting hygienic requirements and prevents unnecessary product losses. Thanks to the metallic stops, the seals used are characterized by a very long service life. This significantly cuts operating costs.

The VARIVENT® design concept reduces consumption of valuable energy and helps you to cut your water consumption as well as the use of chemicals.

The ingenious maintenance concept additionally ensures that the personnel and time required for necessary maintenance work can be reduced to a minimum.

Thus your investment in innovative process technology from GEA Tuchenhagen will quickly repay itself.

Economical

Higher product quality

Reduced consumption of energy, water and cleaning media

Reduced time and personnel costs for maintenance and cleaning



You score points with environmental protection

Lower consumption of energy, water and chemicals means less pollution for the climate and environment. GEA Tuchenhagen meets these requirements by complying with binding international standards.

As a user of GEA Tuchenhagen products, you benefit from proven environmentally-friendly production processes, as well as the high standards for hygienic processing and care of your products. This makes a significant contribution to protecting the global environment and climate.

With our products, you show how important sustainable working processes are to you and that you take responsibility for future generations!

Our support is your gain

In addition to our product range, you can also make use of the individualized engineering support from GEA Tuchenhagen. Even before you have started using our products, this support provides you with extensive digital tools – from technical drawings through to 3-D models.

The individualized service concepts from GEA Tuchenhagen ensure that maintenance work is conducted with the lowest amount of production downtime possible.

We look forward to creating and customizing a maintenance plan for you.

Sustainable
Lower climate and environmental impact
Sustainable, environmentally friendly production processes
High standards for hygienic processing and care of products

Service-oriented
Individual engineering support
Shortest possible interruptions of production
Individual service concept

Hygienic valves

VARIVENT® and ECOVENT® hygienic valves offer reliable function, are suitable for CIP / SIP, easy to maintain and represent a significant factor in consistent product quality. Low operating, maintenance and servicing costs ensure economical system productivity.

The VARIVENT® system has a modular structure, which means it offers a high level of flexibility. The result is economic efficiency for the system operator, optimized stock keeping and low-cost spare parts production due to the reduced diversity of parts.

Modular system
Greater flexibility because of the ability to adapt rapidly to process changes
High economic efficiency
Low spare part stocks

VARIVENT® and ECOVENT® hygienic valves meet the requirements of the European Hygienic Engineering and Design Group (EHEDG) as well as those of 3-A Sanitary Standards, Inc. (3-A SSI).

Numerous valves have been demonstrated to offer trouble-free and efficient cleaning ability not only in accordance with the aforementioned guidelines, but also in independent and standardized cleaning tests (EHEDG certificate).

As well as the safety-relevant aspects of the valve configuration in the hygienic design, this structure additionally offers potential significant savings.



Hygienic design
Lower risk of contaminating the end product
Maximum efficiency in cleaning
Lower CIP costs

Sealing according to the VARIVENT® principle

The hygienic valves are characterized by special seal technology. A metallic stop results in defined seal deformation, ensuring long seal life. This allows for more time to pass between required maintenance services with the process system, thereby allowing for continuous production and shorter downtimes. The special groove shape in the valve disc makes sure the seal has a secure hold at all times up to a pressure differential of 10 bar during switching. The seal geometry was optimized using FEM calculations.

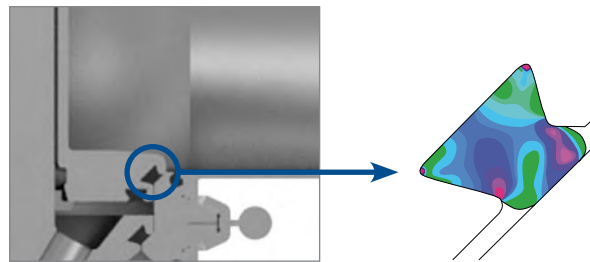

Representation of the stress load on the V-ring

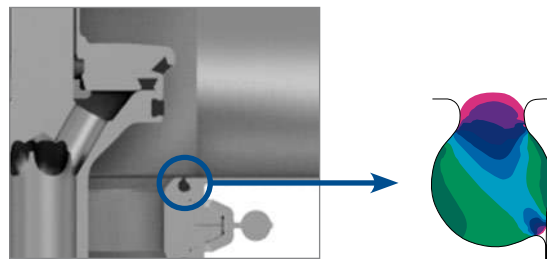

Representation of the stress load with a metallic stop.

Seals
Long operating time
Vacuum-proof
Selection of FDA-compliant seal materials
<ul style="list-style-type: none"> • EPDM • FKM • HNBR

The VARIVENT® modular system

The high flexibility in the VARIVENT® system offers many advantages. With the ability to combine all basic elements with one another, the system offers a broad range of possible applications. Existing valve systems in process installations can be modified or adapted without changing the current system concept.

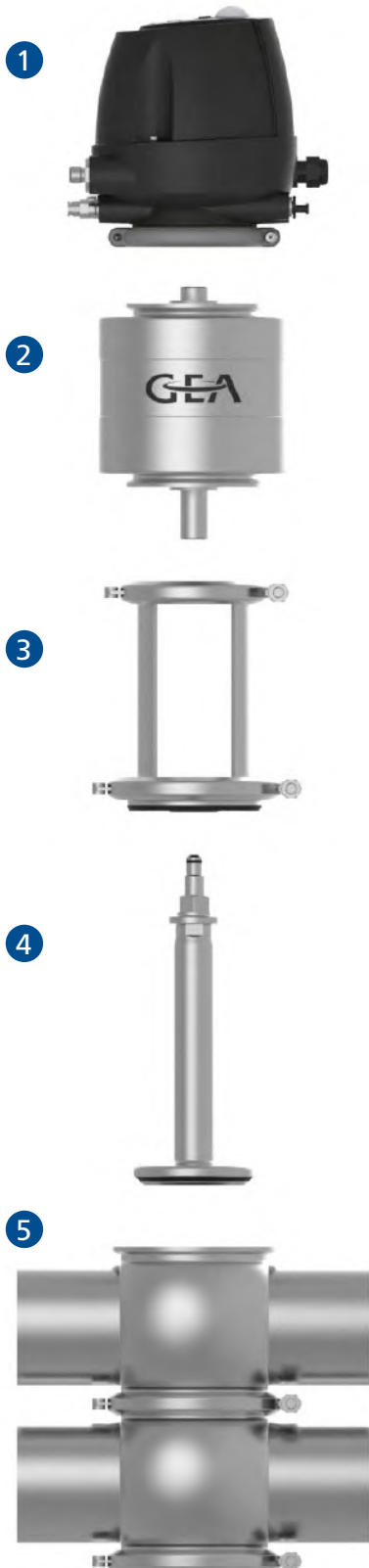

1 Control and feedback system

Both variants of the TVIS® generation offer the opportunity of selecting between two feedback systems variably depending on the customer requirements. Whether the proven sensor technology in the TVIS® M-15 or the innovative path measuring technology in the TVIS® A-15 is used: the TVIS® feedback system is assembled according to customer needs.

2 Actuator

A process-specific selection of the actuator size according to the installation situation results in low air and energy consumption. Depending on the tasks of the valve, various actuator options are available and can be adapted optimally to customer requirements. All actuators can be used in Ex zones as standard, although the Ex-conformity of the electrical add-on components must be taken into account. Furthermore, the actuator contains an integrated interface for mounting a control and feedback system. The internal air supply reduces the risk of failure with external hoses.

3 Lantern

The open lantern separates the actuator and product parts from one another. It permits visual inspection of the stem seal, and is also used for indicating any leakages. Furthermore, heat transfer from the valve housing to the actuator is prevented. In the VARIVENT® valve series, it is possible to integrate additional valve options, for example a limit stop or support of up to two proximity switches.

4 Valve disc

The VARIVENT® system offers an extensive number of different valve types for particular applications in process systems. These are mainly characterized by the different configurations of the valve disc. This concerns in different ways the double disc (upper disc) and the valve disc (lower disc).

5 Valve housing

The height of the dead-zone-free housing exactly corresponds to the diameter of the connection pipeline. This avoids domes and sumps with their negative effects such as oxidization damage or cleaning problems. The special ball shape of the housing offers the best flow profiles without flow separation. Optionally, numerous housing combinations are available with either clamped or welded seats.

Available nominal widths for valve series

	Section	Valve type	Nominal width													2"	3"	4"	6"
			DN	10	15	25	40	50	65	80	100	125	150						
			OD			1"	1 1/2"	2"	2 1/2"	3"	4"		6"						
			IPS																
ECOVENT®	1	Shut-off valve type N				•	•	•	•	•	•	•	•						
	1	Shut-off valve type N small	•	•															
	2	Divert valve type W				•	•	•	•	•	•								
	2	Divert valve type W small	•	•															
	6	Bottom valve type N				•	•	•	•	•	•								
	VARIVENT®	1	Shut-off valve type N				•	•	•	•	•	•	•	•	•	•	•	•	•
1		Long-stroke shut-off valve type N_V								•	•	•							
1		Shut-off valve type U				•	•	•	•	•	•	•	•	•	•	•	•	•	
1		Long-stroke shut-off valve type U_V									•	•							
2		Divert valve type W				•	•	•	•	•	•	•	•	•	•	•	•	•	
2		Divert valve radial sealing type W_R				•	•	•	•	•	•	•							
2		Long-stroke divert valve type W_V								•	•								
2		Divert valve type X				•	•	•	•	•	•	•	•	•	•	•	•	•	
2		Long-stroke divert valve type X_V*								•	•	•							
3		Double-seat valve type D				•	•	•	•	•	•	•	•	•	•	•	•	•	
3		Double-seat valve type B								•	•	•	•	•	•	•	•	•	
3		Double-seat valve type R				•	•	•	•	•	•	•	•	•	•	•	•	•	
3		Double-seat long-stroke valve type D_V*									•	•							
3		Double-seat valve type L_H					•	•	•	•	•								
3		Double-seat valve type L_S					•	•	•	•	•								
3		Double-seat valve type C				•	•	•	•	•	•	•	•						
3		Double-seat valve type K				•	•	•	•	•	•	•	•	•	•	•	•	•	
4		Double-seat valve type D_L, D_C				•	•	•	•	•	•	•	•	•	•	•	•	•	
4		Double-seat valve type B_L, B_C								•	•	•	•	•	•	•	•	•	
4		Double-seat valve type R_L, R_C				•	•	•	•	•	•	•	•	•	•	•	•	•	
4		Double-seat long-stroke valve type D_L/V, D_L/C*									•	•							
4		Double-seat valve type L_HL, L_HC					•	•	•	•	•								
4		Double-seat valve type L_SL, L_SC					•	•	•	•	•								
4		24/7 PMO Valve® 2.0*					•	•	•	•	•		•						
5		Double-seat divert valve type Y				•	•	•	•	•	•	•	•	•	•	•	•	•	
5		Double-seat divert valve type Y_L, Y_C				•	•	•	•	•	•	•	•	•	•	•	•	•	
6		Bottom valve type N				•	•	•	•	•	•	•	•	•	•	•	•	•	
6		Long-stroke bottom valve type N_V								•	•	•							
6		Bottom valve type U				•	•	•	•	•	•	•	•	•	•	•	•	•	
6		Long-stroke bottom valve type U_V									•	•							
6		Double-seat bottom valve type T_R					•	•	•	•	•	•	•	•	•	•	•	•	
6		Double-seat bottom valve type T_RL, T_RC				•	•	•	•	•	•	•	•	•	•	•	•	•	

* Only nominal width OD

Pipe classes

Standard VARIVENT® valve housings are supplied with welding ends, although the valves can be delivered with various connection fittings as an option (see section 7).

The dimensions of the welding ends comply with the following standards:

Metric		Inch		
DN	Outside diameter acc. to DIN 11850, series II; DIN 11866, series A	OD IPS	Outside diameter based on ASME-BPE-a-2004, DIN 11866, series C	Outside diameter acc. to IPS sched. 5
25	29.0 × 1.50	1"	25.4 × 1.65	
40	41.0 × 1.50	1 1/2"	38.1 × 1.65	
50	53.0 × 1.50	2"	50.8 × 1.65	60.3 × 2.00
65	70.0 × 2.00	2 1/2"	63.5 × 1.65	
80	85.0 × 2.00	3"	76.2 × 1.65	88.9 × 2.30
100	104.0 × 2.00	4"	101.6 × 2.11	114.3 × 2.30
125	129.0 × 2.00			
150	154.0 × 2.00	6"	152.4 × 2.77	168.2 × 2.70

Surfaces

The standard for surfaces in contact with the product depends on the particular nominal width standard:

- **Metric, inch OD:** Ra ≤ 0.8 µm
- **Inch IPS:** Ra ≤ 1.2 µm

Higher-quality surfaces are an available option (see section 7).

Surfaces not in contact with the product (housing) are matte blasted as standard. Alternatively, a ground outer surface is available.

Materials

Components in contact with the product are produced from 1.4404/AISI 316 L, while those not in contact with the product are made from 1.4301/AISI 304. Other materials, e.g. for use when handling aggressive fluids, are available on request.

For detailed information about the properties of the materials, refer to the **material properties** table.

Test report and inspection certificate

Optionally, the valve housings and internal components can be supplied with a test report 2.2 or an inspection certificate 3.1 acc. to EN 10204.

If 3.1 inspection certificates are required, please notify us of this when you place the order.

Seal materials

Seals in contact with the product are EPDM (standard), HNBR, FKM and FFKM (on request; not available for all valve types). NBR material is used for seals not in contact with the product. Other materials for seals in contact with the product are available on request. EPDM will be supplied if no seal material is specified in the orders.

The mixing constituents of our seal materials conform to the USP class VI and are contained in the FDA **White List**. In this the sealings are in accordance with **FOOD and DRUG** (FDA) guidelines 21 CFR Part 177.2600 or 21 CFR 177.1550: "Rubber articles intended for repeated use".

The resistance of the seal material depends on the nature and temperature of the product being transported. The contact time with certain products can negatively affect the service life of seals.

For detailed information about the properties of the seal materials, refer to the **seal material properties** table.

Housing connections

Two alternative housing connections are available: the clamped connection (standard) and the fixed housing connection. The clamped housing selection permits a flexible choice of port orientation.

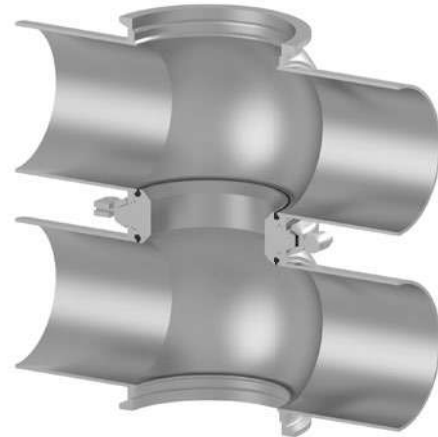

Clamped housing connection:
Seat ring clamped by clamping connection

The advantage of the welded housing connection is that no seals at the seat ring are needed. As a result, the service work during maintenance of the valves is reduced.

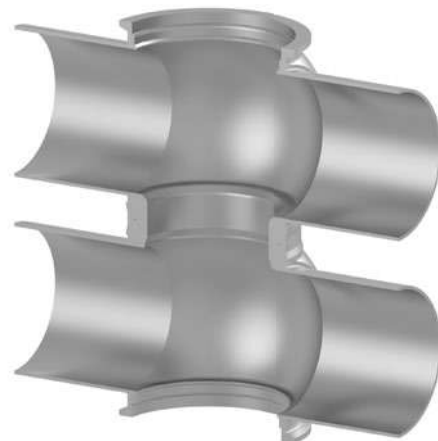

Fixed housing connection:
Housing and seat ring welded (welding housing)

Also mix-matched housing combinations (see section 7) are available on request – both with clamped and fixed housing connection, depending on the valve type.

Ambient conditions

Ambient temperatures	
VARIVENT®/ECOVENT® (with connection 0)	0 °C to 45 °C
	32 °F to 113 °F
Proximity switches	-20 °C to 80 °C
	-4 °F to 176 °F

The valves can also be used outdoors. However, in these application areas they must be protected against icing, or else de-iced before switching or lifting. In addition, the particular requirements on the control and feedback system must be taken into account in this case.

The product or operating temperature depends on the seal material and can be seen in the seal material properties table.

Installation

VARIVENT® and ECOVENT® valves must be installed without stresses. Lateral forces such as expansion of the pipelines due to heat cannot be compensated in the valve, as a result valve damages are possible. In such cases, we recommend taking measures to compensate for the expansion, such as by using the VARICOMP® expansion compensator.

The required clearance for installing and removing a VARIVENT® or ECOVENT® valve is specified in the particular technical data and dimensional sheet.

Air supply

The valve actuators are configured for operation with min. 4 bar and max. 8 bar air pressure. The standard actuator sizes are configured for an air supply pressure of min. 6 bar (with a product pressure of 5 bar). The quality of the air supply must meet the requirements of ISO 8573-1:2010.

ISO 8573-1:2010	
Solid content	Quality class 6
	Particle size max. 5 µm
	Particle density max. 5 mg/m³
Water content	Quality class 4
	Max. dew point 3 °C
	A correspondingly different dew point is required for applications at high altitude or with low ambient temperatures.
Oil content	Quality class 3
	Max. 1 mg oil per 1 m³ air, preferably oil-free

Operating pressure

The valves can be operated down to a negative pressure of -0.95 bar. As standard, the valves are configured for a product pressure up to max. 5 bar (all-round). The maximum product pressure for which the standard valves can be configured is 10 bar. Upon request, individual valve types can be supplied with the nominal pressure level of PS20. It should be noted in this case, however, that when switching the valve, the pressure differential between the upper and lower housing is only allowed to be 10 bar.

Actuator types

The modular structure of VARIVENT® valves makes it possible to equip them with different actuator types. As standard, the valves are supplied with a pneumatic actuator with spring return.

The pneumatic actuators are configured for long-term operation, and are maintenance-free. Optionally, additional actuator types are available (see section 7).

Feedback

In the control top

See section 9: Control and feedback systems

In the lantern (LAT)

Proximity switches of size M12x1 can detect the positions "open" and/or "closed". In double-seat valves with lift actuator, it is also possible to detect the upper valve disc stroke in the lantern by means of a proximity switch (see section 9: Control and feedback systems).

For detecting the end positions by proximity switches in these valves, it is recommended to use the proximity switch holder (INA) on the actuator (see section 9: Control and feedback systems).

Recommended flow direction

If possible, the valves should close against the flow direction in order to avoid water hammer.

Material properties

Material number	Short name	Similar materials			WS***	Main alloy elements in % by mass			
						Cr (Chrome)	Ni (Nickel)	Mo (Molybdenum)	C max. (Carbon)
1.4301*	X5CrNi18-10	AISI 304	BS 304S15	SS2332	18	17.5–19.5	8.0–10.5	-	0.07
1.4404**	X2 CrNiMo 17-12-2	AISI 316L	BS 316S11	SS2348	25	16.5–18.5	10.0–13.0	2.0–2.5	0.03
1.4435	X2 CrNiMo 18-14-3	AISI 316L	BS 316S11	SS2353	27	17.0–19.0	12.5–15.0	2.5–3.0	0.03
1.4462	X2 CrNiMoN 22-5-3	2205	BS 318S13	SS2377	37	21.0–23.0	4.5–6.5	2.5–3.5	0.03
1.4410	X2 CrNiMoN 22-5-3	SAF 2507®	–	SS2328	39	24.0–26.0	6.0–8.0	3.0–4.5	0.03
1.4529	X1 NiCrMoCuN 25-20-7	AISI 926	–	–	42	19.0–21.0	24.0–26.0	6.0–7.0	0.02
AL-6XN®	–	–	–	–	42	20.0–22.0	23.5–25.5	6.0–7.0	0.03
1.4539	X1 NiCrMoCu 25-20-5	AISI 904L	BS 904S13	SS2562	35	19.0–21.0	24.0–26.0	4.0–5.0	0.02
2.4602	NiCr21Mo14W HASTELLOY C-22	–	–	–	69	20.0–22.0	–	12.5–14.5	0.01
2.4819	NiMo16Cr15W HASTELLOY C-276	N 10276	–	–	75	14.5–16.5	–	15.0–17.0	0.01

* Standard material for components not in contact with the product

** Standard material for components in contact with the product (other materials available on request)

*** Effective sum of stainless steels = % Cr + 3.3 * (% Mo + 0.5 W) + 20 N

Seal material properties

Seal material			EPDM	FKM	HNBR	FFKM
General application temperature*			-40 to 135 °C -40 to 275 °F	-10 to 200 °C 14 to 392 °F	-25 to 140 °C -13 to 284 °F	-10 to 230 °C 14 to 446 °F
Medium	Concentration	At permitted operating temperature				
Alkali	≤ 3 %	up to 80 °C	+	○	+	+
	≤ 5 %	up to 40 °C	+	○	○	+
	≤ 5 %	up to 80 °C	+	–	–	+
	> 5 %		○	–	–	+
Inorganic acid**	≤ 3 %	up to 80 °C	+	+	+	+
	≤ 5 %	up to 80 °C	○	+	○	+
	> 5 %	up to 100 °C	–	+	–	+
Water		up to 80 °C	+	+	+	+
Steam		up to 135 °C	+	○	○	+
Steam, approx. 30 min		up to 150 °C	+	○	–	+
Hydrocarbons / fuels			–	+	○	+
Products containing grease	≤ 35 %		+	+	+	+
	> 35 %		–	+	+	+
Oils			–	+	+	+

+ = Good resistance
○ = Reduced service life
– = Not resistant

Other applications on request
* Depending on the installation situation
** Inorganic acids are, for example, hydrochloric acid, nitric acid, sulphuric acid

Catalog
Hygienic Valve Technology

 Hygienic Valves
VARIVENT® and ECOVENT®

 Butterfly Valves T-smart

 Seat Valves T-smart

 Hygienic Valves
and Components

Catalog
Hygienic Pump Technology

 Hygienic Centrifugal Pumps

Catalog
Aseptic Valve Technology

 Aseptic Valve Technology

Catalog
Cleaning Technology

 Cleaning Technology

Hygienic Valves

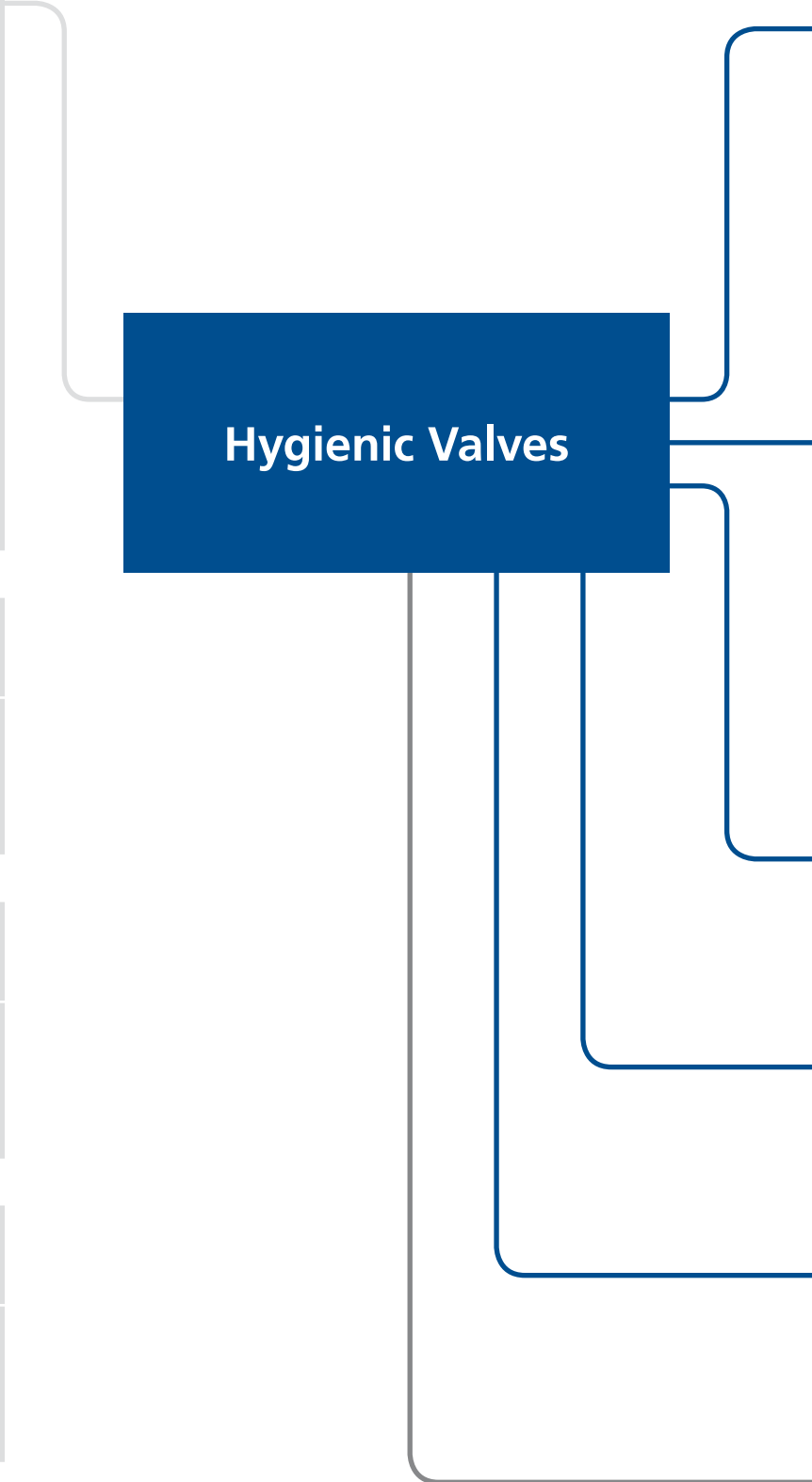

Single-seat valves	Shut-off valves	1
	Divert valves	2
Mixproof seat valves	Mixproof shut-off valves	3
	Mixproof shut-off valves with seat lifting	4
	Mixproof divert valves	5
Tank bottom valves	Single-seat and mixproof tank bottom valves	6
	Options	7
	Spare parts	8
	Control and feedback systems	9



Single-seat shut-off valves

VARIVENT® and ECOVENT® single-seat valves are used for simple shut-off in hygienic applications. The valves are characterized by their ease of operation and flexibility. To avoid water hammers, individual variants in the VARIVENT® modular system are configured for different flow directions.

Function of the valve

In the simple shut-off, there is only one seal in the one-piece valve disc separating the pipelines from one another. This means liquid can pass from one pipeline to the other in the eventuality of a seal defect. For this reason, single-seat shut-off valves are not suitable for separating incompatible products.



Simple shut-off with only one seal



Application examples

In practical use, these valves are used, for example, as emptying/drainage valves or for shutting off a bypass line. Frequently, these types of valve are also used as dosing valves.

The ECOVENT® small valve type N/ECO in nominal widths DN 10 or DN 15 is predominantly used as a feed valve for supplying the spray cleaning of double-seat valves.

Special features

Certified, hygienic configuration

Metallic stop

Flexibility because of the modular principle

Proven seal geometry

Availability of two valve series

VARIVENT®

The structure of the VARIVENT® modular system has many optional versions available to best optimize the valve in the process. Please refer to the options section (section 7) for information about these.



Sizes	
Single-seat shut-off valves	Long-stroke shut-off valves
DN 25–DN 150	DN 65–DN 100
OD 1" –OD 6"	OD 2 ½" –OD 4"
IPS 2" –IPS 6"	

VARIVENT® long-stroke valves are used for transporting fluids with relatively large particles or for viscous products, such as yoghurt with pieces of fruit.

ECOVENT®

The ECOVENT® valve series is characterized by its compact design. Contrary to the VARIVENT® systems with multiple options, this series provides a simple and economical solution for standard requirements.



Sizes
Single-seat shut-off valves
DN 10–DN 100
OD 1" –OD 4"



Housing combinations

VARIVENT® and ECOVENT® single-seat shut-off valves are available with an extremely wide range of housing combinations. In addition, it is possible to select between a clamped and a welded housing connection.

Valve seat version

The clamped housing connection is characterized by a high level of flexibility when it comes to installing the valve. The port orientation of the single-seat shut-off valve can thus be adapted to the pipeline system in question.



Clamped housing connection:
Seat ring clamped by clamping connection

On the other hand, the advantage of the welded valve seat version lies in its low maintenance requirements, because there are no O-rings between the housings.



Welded housing combination:
Housing and seat ring welded (welded housing)

In VARIVENT® and ECOVENT® valve types N, both clamped vertical ports (L0) and a one-piece housing (V0) are available for the housing combinations L and T.



L0-housing



V0-housing

Recommended flow direction

To avoid water hammers when closing the valve while the product is flowing, single-seat shut-off valves should be switched against the flow direction of the product. Valve type N is designed for a flow from the lower to the upper pipeline, whereas valve type U is for the opposite flow direction. Valve type U is only available in the VARIVENT® series, thus making clear one of the major differences between VARIVENT® and ECOVENT®: the difference in the number of variants available in both series.



Valve type N

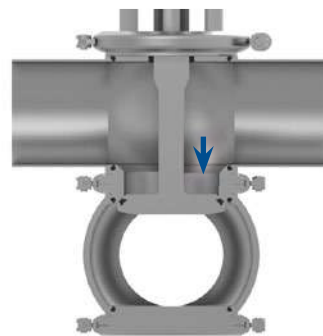

Valve type U

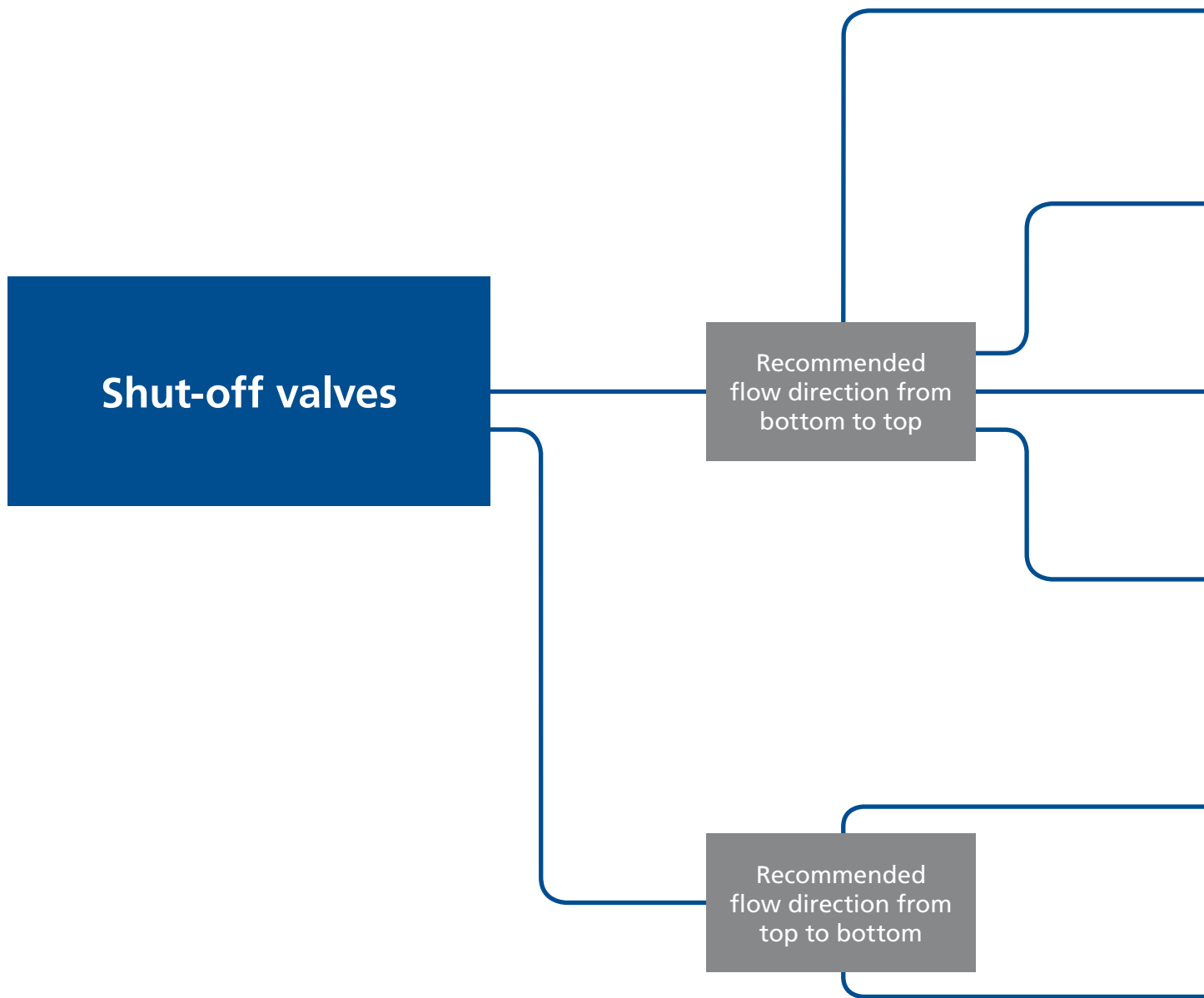

Modular system

VARIVENT®
single-seat valve
type N

Compact design

ECOVENT®
single-seat valve
type N/ECO

Small
nominal width
DN 10 or DN 15

ECOVENT®
single-seat valve
type N/ECO Small

Viscous product
or product with
large particles

VARIVENT®
single-seat long-stroke valve
type N_V

Modular system

VARIVENT®
single-seat valve
type U

Viscous product
or product with
large particles

VARIVENT®
single-seat long-stroke valve
type U_V



Technical data of the standard version		
Recommended flow direction	From bottom to top	
Material in contact with the product	1.4404/AISI 316 L	
Material not in contact with the product	1.4301/AISI 304	
Seal material in contact with the product	EPDM, FKM, HNBR	
Ambient temperature	0 to 45 °C	
Air supply pressure	6 bar (87 psi)	
Product pressure	5 bar (73 psi)	
Surface in contact with the product	DN, OD	Ra ≤ 0.8 µm
	IPS	Ra ≤ 1.2 µm
External housing surface	Matte blasted	
Control and feedback system	Connection 0 (without control top)	
Actuator type	Pneumatic actuator air/spring	
Connection fittings	Welding end	
Identification	Adhesive ID tag	
Valve seat version	Clamped or welded seat ring	
Certificates		

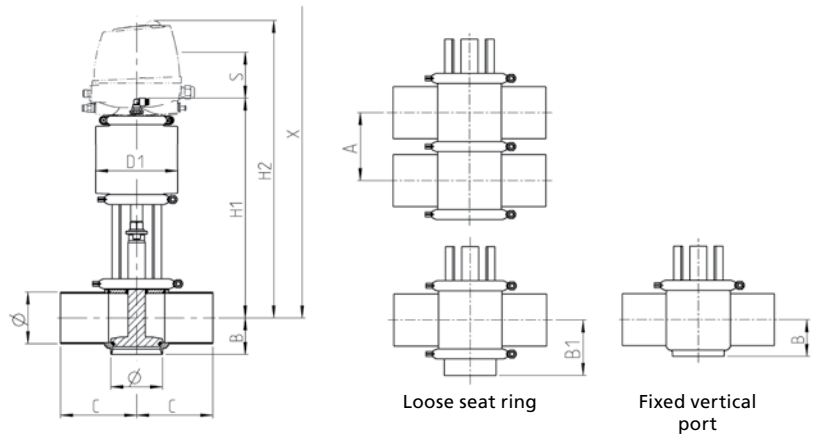

Nominal width	Pipe	Housing				Actuator	Dimensions			Valve	
	Ø [mm]	A [mm]	B [mm]	B1 [mm]	C [mm]	D1 [mm]	H1 [mm]	H2 [mm]	Extension X [mm]	Stroke S [mm]	Weight [kg]
DN 25	29.0 × 1.50	50.0	31	58	90	99	294	423	508	16	6
DN 40	41.0 × 1.50	62.0	39	64	90	110	335	464	549	18	8
DN 50	53.0 × 1.50	74.0	41	70	90	110	341	470	555	30	8
DN 65	70.0 × 2.00	96.0	52	83	125	135	352	481	626	30	13
DN 80	85.0 × 2.00	111.0	60	90	125	135	360	489	634	30	13
DN 100	104.0 × 2.00	130.0	70	100	125	170	399	528	673	30	19
DN 125	129.0 × 2.00	155.0	113	112	150	260	555	684	884	60	46
DN 150	154.0 × 2.00	180.0	125	125	150	260	579	708	908	60	51
OD 1"	25.4 × 1.65	46.0	29	56	90	99	292	421	506	12	6
OD 1 ½"	38.1 × 1.65	59.0	39	62	90	110	337	466	551	18	8
OD 2"	50.8 × 1.65	71.5	42	68	90	110	343	472	557	30	8
OD 2 ½"	63.5 × 1.65	90.0	54	80	125	135	356	485	630	31	13
OD 3"	76.2 × 1.65	103.0	54	86	125	135	363	492	637	29	13
OD 4"	101.6 × 2.11	127.5	69	99	125	170	401	530	675	30	20
OD 6"	152.4 × 2.77	177.0	124	123	150	260	578	707	907	57	51
IPS 2"	60.3 × 2.00	81.0	44	73	114.3	110	338	467	552	30	8
IPS 3"	88.9 × 2.30	115.0	63	92	152.5	135	358	487	632	30	13
IPS 4"	114.3 × 2.30	140.0	75	105	152.5	170	394	523	668	30	20
IPS 6"	168.2 × 2.70	192.0	131	131	152.5	260	573	702	902	60	51



Position	Description of the order code for the standard version								
1	Valve type								
	N VARIVENT® single-seat valve								
2	Housing combinations								
	A	B	C	E	L	T			
3	Supplement to the valve type								
	Reserved for options								
4/5	Nominal width (upper housing / lower housing)								
	DN 25	OD 1"							
	DN 40	OD 1 ½"							
	DN 50	OD 2"		IPS 2"					
	DN 65	OD 2 ½"							
	DN 80	OD 3"		IPS 3"					
	DN 100	OD 4"		IPS 4"					
	DN 125								
	DN 150	OD 6"		IPS 6"					
6	Actuator type								
	S Air/Spring								
7	Non-actuated position								
	Z Spring-to-close (NC)								
	A Spring-to-open (NO)								
8	Standard configuration with 6 bar air supply pressure for 5 bar product pressure (higher pressures on request)								
	Actuator (spring-to-close)	Actuator (spring-to-open)		For nominal widths					
	AA	AA		DN 25, OD 1"					
	BB	BA		DN 40, DN 50, OD 1 ½", OD 2", IPS 2"					
	CD	CB		DN 65, DN 80, OD 2 ½", OD 3", IPS 3"					
	DF	DD		DN 100, OD 4", IPS 4"					
	SH6	EF6		DN 125					
	SK6	SG6		DN 150, OD 6", IPS 6"					
9	Valve seat version (upper housing / lower housing)			Housing combination					
	L0	Loose seat ring/Clamp connection		A	B	C	E	L	T
	V0	Fixed vertical port		√	√	√	√	√	√
	V1	Welded seat ring/ Port orientation 90°							
	V2	Welded seat ring/ Port orientation 180°							
	V3	Welded seat ring/ Port orientation 270°							
10	Seal material in contact with the product								
	1 EPDM (FDA)								
	2 FKM (FDA)								
	3 HNBR (FDA); (up to DN 100, OD 4", IPS OD 4")								
11	Surface quality of the housing								
	1 Inside Ra ≤ 1.2 µm, outside matte blasted (IPS)								
	2 Inside Ra ≤ 0.8 µm, outside matte blasted (DN, OD)								
12	Connection fittings								
	N Welding end								
13	Accessories								
	/52 Adhesive ID tag								
+									
14-19	Air connection / Control and feedback system								
	00000M Metric for air hose Ø 6/4 mm								
	00000Z Inch for air hose Ø OD ¼" (6.35/4.35 mm)								
	XXXXX Order code for different control and feedback systems see section 9								

The code is composed as following, depending on the chosen configuration:

Position	1	2	3	4/5	6	7	8	9	10	11	12	13	14 to 19					
Code	N			/	S						N	/52						







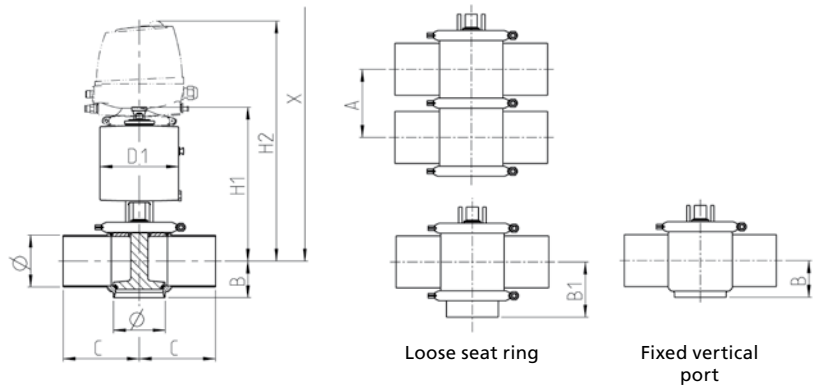







For order codes differing from the standard version, please refer to section 7 (options).



Technical data of the standard version	
Recommended flow direction	From bottom to top
Material in contact with the product	1.4404/AISI 316 L
Material not in contact with the product	1.4301/AISI 304
Seal material in contact with the product	EPDM, FKM, HNBR
Ambient temperature	0 to 45 °C
Air supply pressure	6 bar (87 psi)
Product pressure	5 bar (73 psi)
Surface in contact with the product	Ra ≤ 0.8 µm
External housing surface	Matte blasted
Control and feedback system	Connection 0 (without control top)
Actuator type	Pneumatic actuator air/spring
Connection fittings	Welding end
Identification	Adhesive ID tag
Valve seat version	Clamped or welded seat ring
Certificates	



Nominal width	Pipe	Housing				Actuator	Dimensions			Valve	
	Ø [mm]	A [mm]	B [mm]	B1 [mm]	C [mm]	D1 [mm]	H1 [mm]	H2 [mm]	Extension X [mm]	Stroke S [mm]	Weight [kg]
DN 25	29.0 × 1.50	50.0	31	58.0	90	99	209	338	423	16.0	5
DN 40	41.0 × 1.50	62.0	39	64.0	90	110	243	372	457	20.0	7
DN 50	53.0 × 1.50	74.0	41	70.0	90	110	249	378	463	28.0	7
DN 65	70.0 × 2.00	96.0	52	83.0	125	135	257	386	531	28.0	11
DN 80	85.0 × 2.00	111.0	60	90.5	125	135	264	393	538	28.0	11
DN 100	104.0 × 2.00	130.0	70	100.0	125	170	274	403	548	28.0	16
OD 1"	25.4 × 1.65	46.0	29	56.0	90	99	207	336	421	12.0	5
OD 1 ½"	38.1 × 1.65	59.0	39	62.5	90	110	241	370	455	17.0	7
OD 2"	50.8 × 1.65	71.5	42	69.0	90	110	248	377	462	25.5	7
OD 2 ½"	63.5 × 1.65	90.0	54	80.0	125	135	254	383	528	22.0	11
OD 3"	76.2 × 1.65	103.0	54	86.5	125	135	260	389	534	20.0	11
OD 4"	101.6 × 2.11	127.5	69	99.0	125	170	273	402	547	25.5	17



Position	Description of the order code for the standard version							
1	Valve type							
	N ECOVENT® single-seat valve							
2	Housing combinations							
	A	B	C	E	L	T		
								
3	Supplement to the valve type							
	/ECO							
4/5	Nominal width (upper housing / lower housing)							
	DN 25						OD 1"	
	DN 40						OD 1 ½"	
	DN 50						OD 2"	
	DN 65						OD 2 ½"	
	DN 80						OD 3"	
	DN 100						OD 4"	
6	Actuator type							
	E Air/Spring							
7	Non-actuated position							
	Z Spring-to-close (NC)							
	A Spring-to-open (NO)							
8	Standard configuration with 6 bar air supply pressure for 5 bar product pressure (higher pressures on request)							
	Actuator (spring-to-close)	Actuator (spring-to-open)		For nominal widths				
	EAA	EAA		DN 25, OD 1"				
	EBB	EBA		DN 40, DN 50, OD 1 ½", OD 2"				
	ECD	ECB		DN 65, DN 80, OD 2 ½", OD 3"				
	EDF	EDD		DN 100, OD 4"				
9	Valve seat version (upper housing / lower housing)		Housing combination					
	L0	Loose seat ring/Clamp connection	A	B	C	E	L	T
	V0	Fixed vertical port	√	√	√	√	√	√
	V1	Welded seat ring/ Port orientation 90°						
	V2	Welded seat ring/ Port orientation 180°						
	V3	Welded seat ring/ Port orientation 270°						
10	Seal material in contact with the product							
	1 EPDM (FDA)							
	2 FKM (FDA)							
	3 HNBR (FDA)							
11	Surface quality of the housing							
	2 Inside Ra ≤ 0.8 µm, outside matte blasted							
12	Connection fittings							
	N Welding end							
13	Accessories							
	/52 Adhesive ID tag							
+								
14-19	Air connection / Control and feedback system							
	00000M	Metric for air hose Ø 6/4 mm						
	00000Z	Inch for air hose Ø OD ¼" (6.35/4.35 mm)						
	XXXXX	Order code for different control and feedback systems see section 9						

The code is composed as following, depending on the chosen configuration:

Position	1	2	3	4/5	6	7	8	9	10	11	12	13	14 to 19				
Code	N		/ECO	/	E					2	N	/52					

For order codes differing from the standard version, please refer to section 7 (options).



Technical data of the standard version	
Recommended flow direction	From bottom to top
Material in contact with the product	1.4404/AISI 316 L
Material not in contact with the product	1.4301/AISI 304
Seal material in contact with the product	EPDM, FKM, HNBR
Ambient temperature	0 to 45 °C
Air supply pressure	5 bar (73 psi)
Product pressure	10 bar (145 psi)
Surface in contact with the product	Ra ≤ 0.8 µm
External housing surface	Matte blasted
Control and feedback system	Connection 0 (without control top)
Actuator type	Pneumatic actuator air/spring
Connection fittings	Welding end
Identification	Adhesive ID tag
Valve seat version	Fixed vertical port
Certificates	 

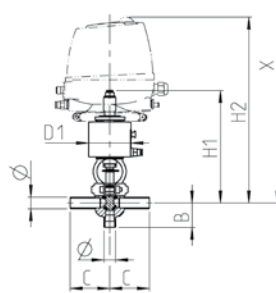

Nominal width	Pipe	Housing			Actuator	Dimensions			Valve	
	Ø [mm]	A [mm]	B [mm]	C [mm]	D1 [mm]	H1 [mm]	H2 [mm]	Extension X [mm]	Stroke S [mm]	Weight [kg]
DN 10	13 × 1.50	44	40	65	70	166	295	345	8.5	4
DN 15	19 × 1.50	44	40	65	70	169	298	348	8.5	4

Position	Description of the order code for the standard version					
1	Valve type N ECOVENT® single-seat valve					
2	Housing combinations 					
3	Supplement to the valve type /ECO					
4/5	Nominal width (upper housing / lower housing) DN 10 DN 15					
6	Actuator type E Air/Spring					
7	Non-actuated position Z Spring-to-close (NC) A Spring-to-open (NO)					
8	Standard configuration with 5 bar air supply pressure for 10 bar product pressure (higher pressures on request) <table border="1"> <tr> <th>Actuator (spring-to-close)</th> <th>Actuator (spring-to-open)</th> </tr> <tr> <td>60/4</td> <td>60/4</td> </tr> </table>		Actuator (spring-to-close)	Actuator (spring-to-open)	60/4	60/4
Actuator (spring-to-close)	Actuator (spring-to-open)					
60/4	60/4					
9	Valve seat version (upper housing / lower housing) V0 Fixed vertical port	Housing combination <table border="1"> <tr> <th>L</th> <th>T</th> </tr> <tr> <td>√</td> <td>√</td> </tr> </table>	L	T	√	√
L	T					
√	√					
10	Seal material in contact with the product 1 EPDM (FDA) 2 FKM (FDA) 3 HNBR (FDA)					
11	Surface quality of the housing 2 Inside Ra ≤ 0.8 μm, outside matte blasted					
12	Connection fittings N Welding end					
13	Accessories /52 Adhesive ID tag					
+						
14-19	Air connection / Control and feedback system 00000M Metric for air hose Ø 6/4 mm 00000Z Inch for air hose Ø OD ¼" (6.35/4.35 mm) XXXXX Order code for different control and feedback systems see section 9					

The code is composed as following, depending on the chosen configuration:

Position	1	2	3	4/5	6	7	8	9	10	11	12	13	14 to 19					
Code	N		/ECO	/	E		60/4	V0			N	/52						

For order codes differing from the standard version, please refer to section 7 (options).





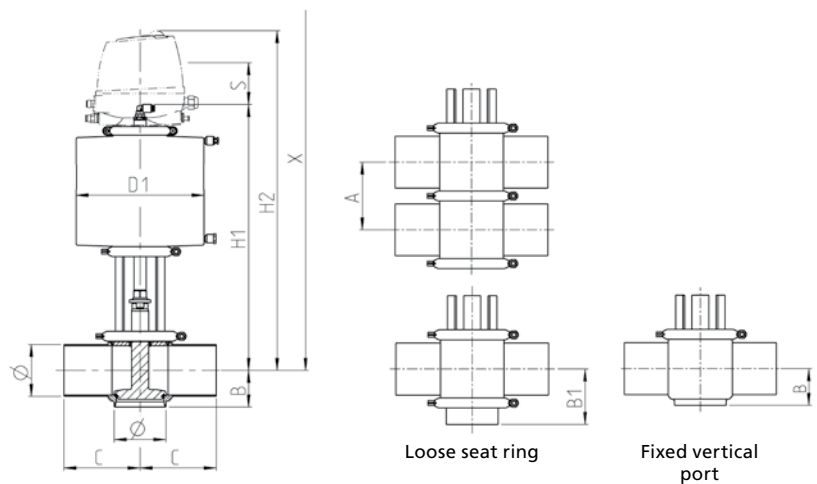







Technical data of the standard version	
Recommended flow direction	From bottom to top
Material in contact with the product	1.4404/AISI 316 L
Material not in contact with the product	1.4301/AISI 304
Seal material in contact with the product	EPDM, FKM, HNBR
Ambient temperature	0 to 45 °C
Air supply pressure	4.8 bar (70 psi)
Product pressure	DN 65–DN 80 OD 2 ½" –OD 3" 10 bar (145 psi)
	DN 100 OD 4" 5.2 bar (75 psi)
Surface in contact with the product	Ra ≤ 0.8 µm
External housing surface	Matte blasted
Control and feedback system	Connection 0 (without control top)
Actuator type	Pneumatic actuator air/spring
Connection fittings	Welding end
Identification	Adhesive ID tag
Valve seat version	Clamped or welded seat ring
Certificates	



Nominal width	Pipe	Housing				Actuator	Dimensions			Valve	
	Ø [mm]	A [mm]	B [mm]	B1 [mm]	C [mm]	D1 [mm]	H1 [mm]	H2 [mm]	Extension X [mm]	Stroke S [mm]	Weight [kg]
DN 65	70.0 × 2.00	96.0	52	83.0	125	210	421	550	695	41.5	23
DN 80	85.0 × 2.00	111.0	60	90.5	125	210	429	558	703	56.5	23
DN 100	104.0 × 2.00	130.0	70	100.0	125	210	438	567	712	60.0	25
OD 2 ½"	63.5 × 1.65	90.0	54	80.0	125	210	425	554	699	42.5	23
OD 3"	76.2 × 1.65	103.0	54	86.5	125	210	432	561	706	55.5	23
OD 4"	101.6 × 2.11	127.5	69	99.0	125	210	440	569	714	60.5	26



Position	Description of the order code for the standard version						
1	Valve type N VARIVENT® single-seat valve						
2	Housing combinations 						
3	Supplement to the valve type V Long-stroke						
4/5	Nominal width (upper housing / lower housing) DN 65 OD 2 ½" DN 80 OD 3" DN 100 OD 4"						
6	Actuator type L Air/spring, long stroke						
7	Non-actuated position Z Spring-to-close (NC) A Spring-to-open (NO)						
8	Standard configuration with 4.8 bar air supply pressure for 10 bar (DN 65–DN 80, OD 2 ½"–OD 3") or 5.2 bar (DN 100, OD 4") product pressure, respectively – (higher pressures on request) Actuator (spring-to-close) ZEF/V Actuator (spring-to-open) ZEF/V						
9	Valve seat version (upper housing / lower housing)	Housing combination					
	L0 Loose seat ring/Clamp connection	A	B	C	E	L	T
	V0 Fixed vertical port	√	√	√	√	√	√
	V1 Welded seat ring/ Port orientation 90°						
	V2 Welded seat ring/ Port orientation 180°						
	V3 Welded seat ring/ Port orientation 270°						
10	Seal material in contact with the product 1 EPDM (FDA) 2 FKM (FDA) 3 HNBR (FDA)						
11	Surface quality of the housing 2 Inside Ra ≤ 0.8 µm, outside matte blasted						
12	Connection fittings N Welding end						
13	Accessories /52 Adhesive ID tag						
+							
14–19	Air connection / Control and feedback system 00000M Metric for air hose Ø 6/4 mm 00000Z Inch for air hose Ø OD ¼" (6.35/4.35 mm) XXXXX Order code for different control and feedback systems see section 9						

The code is composed as following, depending on the chosen configuration:

Position	1	2	3	4/5	6	7	8	9	10	11	12	13	14 to 19				
Code	N		V	/	L		ZEF/V			2	N	/52					

For order codes differing from the standard version, please refer to section 7 (options).



Technical data of the standard version		
Recommended flow direction	From top to bottom	
Material in contact with the product	1.4404/AISI 316 L	
Material not in contact with the product	1.4301/AISI 304	
Seal material in contact with the product	EPDM, FKM, HNBR	
Ambient temperature	0 to 45 °C	
Air supply pressure	6 bar (87 psi)	
Product pressure	5 bar (73 psi)	
Surface in contact with the product	DN, OD	Ra ≤ 0.8 µm
	IPS	Ra ≤ 1.2 µm
External housing surface	Matte blasted	
Control and feedback system	Connection 0 (without control top)	
Actuator type	Pneumatic actuator air/spring	
Connection fittings	Welding end	
Identification	Adhesive ID tag	
Valve seat version	Clamped or welded seat ring	
Certificates		

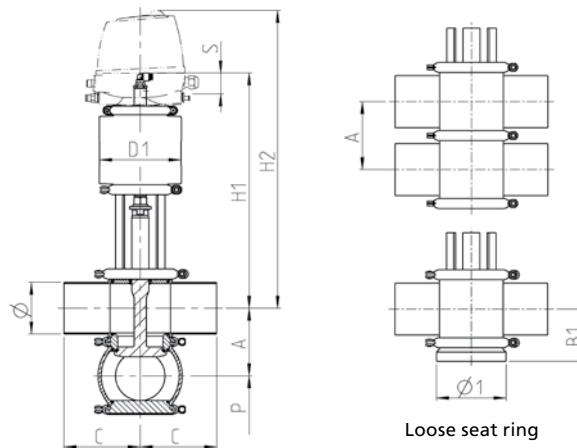

Nominal width	Pipe		Housing			Actuator	Dimensions			Valve	
	Ø [mm]	Ø1 [mm]	A [mm]	B1 [mm]	C [mm]	D1 [mm]	H1 [mm]	H2 [mm]	P [mm]	Stroke S [mm]	Weight [kg]
DN 25	29.0 × 1.50	70 × 2	50.0	50.0	90.0	99	294	423	200	18	8
DN 40	41.0 × 1.50	85 × 2	62.0	56.0	90.0	110	335	464	200	25	11
DN 50	53.0 × 1.50	85 × 2	74.0	62.0	90.0	110	341	470	200	29	11
DN 65	70.0 × 2.00	114 × 3	96.0	78.0	125.0	135	352	481	230	30	17
DN 80	85.0 × 2.00	114 × 3	111.0	85.5	125.0	135	360	489	230	30	18
DN 100	104.0 × 2.00	154 × 2	130.0	95.0	125.0	170	399	528	250	30	25
DN 125	129.0 × 2.00	184 × 3	155.0	107.5	150.0	260	555	684	300	60	56
DN 150	154.0 × 2.00	212 × 4	180.0	120.0	150.0	260	579	708	300	60	63
OD 1"	25.4 × 1.65	70 × 2	46.0	48.0	90.0	99	292	421	200	22	8
OD 1 ½"	38.1 × 1.65	85 × 2	59.0	54.5	90.0	110	337	466	200	25	10
OD 2"	50.8 × 1.65	85 × 2	71.5	60.8	90.0	110	343	472	200	28	11
OD 2 ½"	63.5 × 1.65	114 × 3	90.0	75.0	125.0	135	356	485	230	29	17
OD 3"	76.2 × 1.65	114 × 3	103.0	81.5	125.0	135	363	492	230	31	17
OD 4"	101.6 × 2.11	154 × 2	127.5	93.8	125.0	170	401	530	250	29	25
OD 6"	152.4 × 2.77	212 × 4	177.0	118.5	150.0	260	578	707	300	60	64
IPS 2"	60.3 × 2.00	85 × 2	81.0	65.5	114.3	110	338	467	200	29	12
IPS 3"	88.9 × 2.30	114 × 3	115.0	87.5	152.5	135	358	487	230	30	19
IPS 4"	114.3 × 2.30	154 × 2	140.0	100.0	152.5	170	394	523	250	30	27
IPS 6"	168.2 × 2.70	212 × 4	192.0	126.0	152.5	260	573	702	300	60	65



Position	Description of the order code for the standard version								
1	Valve type								
	U VARIVENT® single-seat valve								
2	Housing combinations								
	A	B	C	E	F*	D*			
3	Supplement to the valve type								
	Reserved for options								
4/5	Nominal width (upper housing / lower housing)								
	DN 25	OD 1"							
	DN 40	OD 1 ½"							
	DN 50	OD 2"		IPS 2"					
	DN 65	OD 2 ½"							
	DN 80	OD 3"		IPS 3"					
	DN 100	OD 4"		IPS 4"					
	DN 125								
	DN 150	OD 6"		IPS 6"					
6	Actuator type								
	S Air/Spring								
7	Non-actuated position								
	Z Spring-to-close (NC)								
	A Spring-to-open (NO)								
8	Standard configuration with 6 bar air supply pressure for 5 bar product pressure (higher pressures on request)								
	Actuator (spring-to-close)	Actuator (spring-to-open)		For nominal widths					
	AA	AA		DN 25, OD 1"					
	BB	BA		DN 40, DN 50, OD 1 ½", OD 2", IPS 2"					
	CD	CB		DN 65, DN 80, OD 2 ½", OD 3", IPS 3"					
	DF	DD		DN 100, OD 4", IPS 4"					
	SH6	EF6		DN 125					
	SK6	SG6		DN 150, OD 6", IPS 6"					
9	Valve seat version (upper housing / lower housing)			Housing combination					
	L0	Loose seat ring/Clamp connection		A	B	C	E	F*	D*
				√	√	√	√	√	√
	V1	Welded seat ring/ Port orientation 90°							
	V2	Welded seat ring/ Port orientation 180°							
	V3	Welded seat ring/ Port orientation 270°							
10	Seal material in contact with the product								
	1 EPDM (FDA)								
	2 FKM (FDA)								
	3 HNBR (FDA); (bis DN 100, OD 4", IPS OD 4")								
11	Surface quality of the housing								
	1 Inside Ra ≤ 1.2 µm, outside matte blasted (IPS)								
	2 Inside Ra ≤ 0.8 µm, outside matte blasted (DN, OD)								
12	Connection fittings								
	N Welding end								
13	Accessories								
	/52 Adhesive ID tag								
+									
14-19	Air connection/Control and feedback system								
	00000M Metric for air hose Ø 6/4 mm								
	00000Z Inch for air hose Ø OD ¼" (6.35/4.35 mm)								
	XXXXX Order code for different control and feedback systems see section 9								

* with housing connection flange U

The code is composed as following, depending on the chosen configuration:

Position	1	2	3	4/5	6	7	8	9	10	11	12	13	14 to 19		
Code	U			/	S						N	/52			

For order codes differing from the standard version, please refer to section 7 (options).



Technical data of the standard version





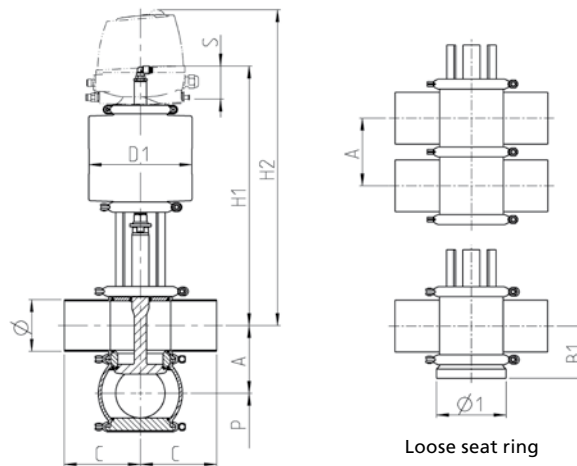





Recommended flow direction	From top to bottom	
Material in contact with the product	1.4404/AISI 316 L	
Material not in contact with the product	1.4301/AISI 304	
Seal material in contact with the product	EPDM, FKM, HNBR	
Ambient temperature	0 to 45 °C	
Air supply pressure	4.8 bar (70 psi)	
Product pressure	DN 80	5 bar (73 psi)
	OD 3"	
	DN 100	5.6 bar (81 psi)
	OD 4"	
Surface in contact with the product	Ra ≤ 0.8 µm	
External housing surface	Matte blasted	
Control and feedback system	Connection 0 (without control top)	
Actuator type	Pneumatic actuator air/spring	
Connection fittings	Welding end	
Identification	Adhesive ID tag	
Valve seat version	Clamped or welded seat ring	

Certificates



Nominal width	Pipe		Housing			Actuator	Dimensions			Valve	
	Ø [mm]	Ø1 [mm]	A [mm]	B1 [mm]	C [mm]	D1 [mm]	H1 [mm]	H2 [mm]	P [mm]	Stroke S [mm]	Weight [kg]
DN 80	85.0 × 2.00	114 × 3	111.0	85.5	125	170	390	519	230	40	21
DN 100	104.0 × 2.00	154 × 2	130.0	95.0	125	210	409	538	250	40	29
OD 3"	76.2 × 1.65	114 × 3	103.0	81.5	125	170	393	522	230	41	21
OD 4"	101.6 × 2.11	154 × 2	127.5	93.8	125	210	411	540	250	39	29



Position	Description of the order code for the standard version							
1	Valve type U VARIVENT® single-seat valve							
2	Housing combinations 							
3	Supplement to the valve type V Long-stroke							
4/5	Nominal width (upper housing / lower housing) DN 80 OD 3" DN 100 OD 4"							
6	Actuator type S Air/Spring							
7	Non-actuated position Z Spring-to-close (NC) A Spring-to-open (NO)							
8	Standard configuration with 4.8 bar air supply pressure for 5 bar (DN 80, OD 3") or 5.6 bar (DN 100, OD 4") product pressure, respectively – (higher pressures on request)							
	Actuator (spring-to-close)		Actuator (spring-to-open)		For nominal widths			
	DD5		DD5		DN 80, OD 3"			
	EF5		EF5		DN 100, OD 4"			
9	Valve seat version (upper housing / lower housing)		Housing combination					
	L0 Loose seat ring/Clamp connection		A	B	C	E	F*	D*
			√	√	√	√	√	√
	V1 Welded seat ring/Port orientation 90°							
	V2 Welded seat ring/Port orientation 180°							
	V3 Welded seat ring/Port orientation 270°							
10	Seal material in contact with the product 1 EPDM (FDA) 2 FKM (FDA) 3 HNBR (FDA)							
11	Surface quality of the housing 2 Inside Ra ≤ 0.8 µm, outside matte blasted							
12	Connection fittings N Welding end							
13	Accessories /52 Adhesive ID tag							
+								
14–19	Air connection / Control and feedback system 00000M Metric for air hose Ø 6/4 mm 00000Z Inch for air hose Ø OD ¼" (6.35/4.35 mm) XXXXX Order code for different control and feedback systems see section 9							

* with housing connection flange U

The code is composed as following, depending on the chosen configuration:

Position	1	2	3	4/5	6	7	8	9	10	11	12	13	14 to 19				
Code	U		V	/	S					2	N	/52					

For order codes differing from the standard version, please refer to section 7 (options).



Single-seat divert valves

VARIVENT® and ECOVENT® single-seat divert valves are used for simple divert functions in hygienic applications. The valves are characterized by their ease of operation and flexibility. The individual variants are designed for different flow directions.

Function of the valve

In single-seat divert valves, there is only one seal for each switching position in the valve disc separating the particular pipelines from one another. This means liquid can pass from one pipeline to the other in the eventuality of a seal defect. For this reason, single-seat divert valves are not suitable for separating incompatible fluids.

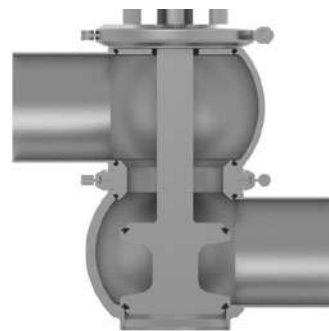

Simple divert valve with only one seal



Application examples

In practice, these valves are frequently used in CIP supply and return lines. One typical application is also found at the end of a valve block in which the valves are fitted as divert valves between the process line and the drainage (e.g. during pushing out).

Special features

Certified, hygienic configuration

Metallic stop

Flexibility because of the modular principle

Proven seal geometry

Availability of two valve series

VARIVENT®

The structure of the VARIVENT® modular system means that different valve configurations (closing direction of the valve disc) and numerous options are available. Please refer to the options section (section 7) for information about these.



ECOVENT®

The ECOVENT® valve series is characterized by its compact design. Contrary to the VARIVENT® systems with multiple options, this series provides a simple and economical solution for standard requirements.



Sizes	
Single-seat divert valves	Long-stroke divert valves
DN 25–DN 150	DN 65–DN 100
OD 1"–OD 6"	OD 2 ½"–OD 4"
IPS 2"–IPS 6"	

Sizes
Single-seat divert valves
DN 10–DN 100
OD 1"–OD 4"

VARIVENT® long-stroke valves are used for manufacturing products with relatively large particles or for viscous products, such as strawberry yoghurt.

Housing combinations

VARIVENT® and ECOVENT® single-seat divert valves are available with an extremely wide range of housing combinations.

Valve seat version

The valves are configured with a clamped housing connection that is characterized by a high level of flexibility during installation of the valve.

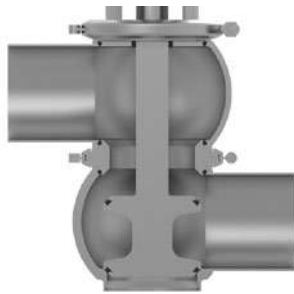

Valve type W

Maintenance

To allow the valve disc to be removed and the seals in the seat ring renewed during maintenance, it is at least necessary to remove the upper housing from the pipeline. For this reason a clamped connection, e.g. a VARIVENT® flange connection, is recommended to be provided on the affected housings or in the connected pipeline system right from the planning phase.

Maintenance in the divert valve type W_R

The radial seal divert valve type W_R was developed to offer the advantage of the welded valve seat version. This design is characterized by its low maintenance requirement. The valve disc with the radial seal can easily be removed upwards through the seat ring. Furthermore, there is no need to renew any O-rings in the seat ring.

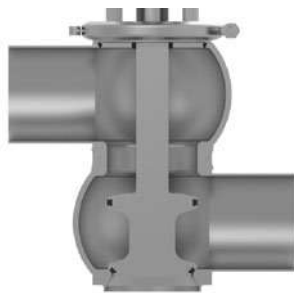

Valve type W_R

Recommended flow direction

To avoid water hammers when closing one path while the product is flowing, single-seat divert valves should be switched against the flow direction of the product if possible. The single-seat divert valve type W is used for merging products from two pipelines, whereas valve type X has been designed for product distribution. The valves are characterized by their ease of operation. Valve type X is only available in the VARIVENT® series, thus making clear one of the major differences between VARIVENT® and ECOVENT®: the difference in the number of variants available in both series.

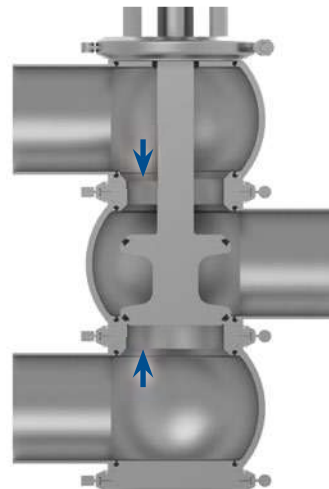

Valve type W

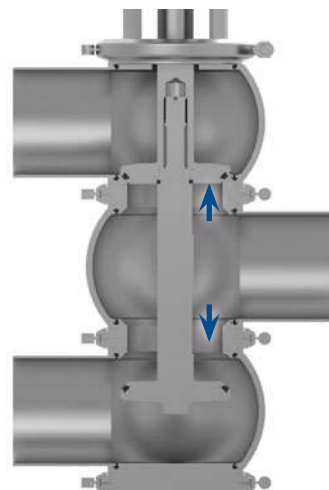



Valve type X

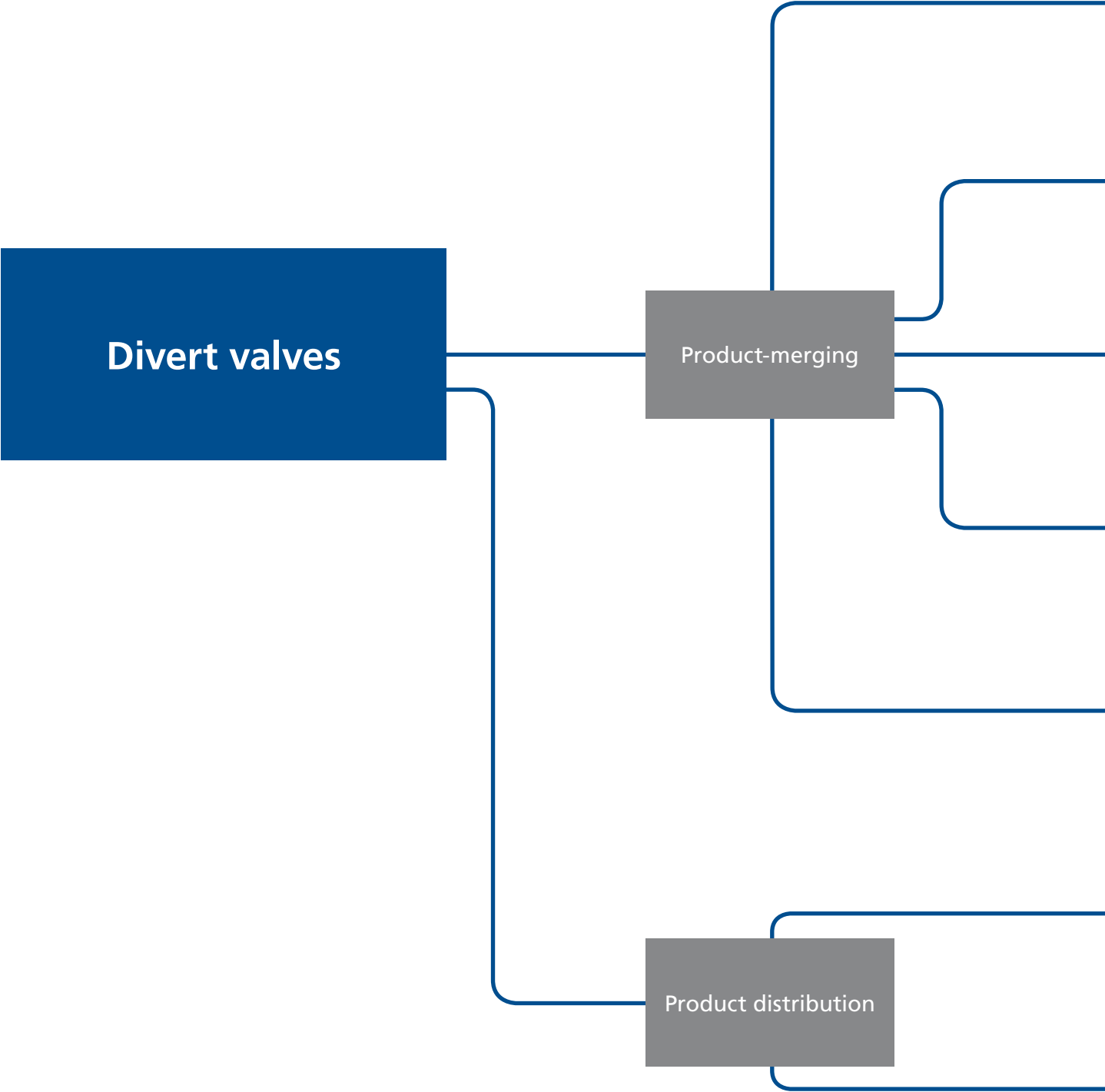

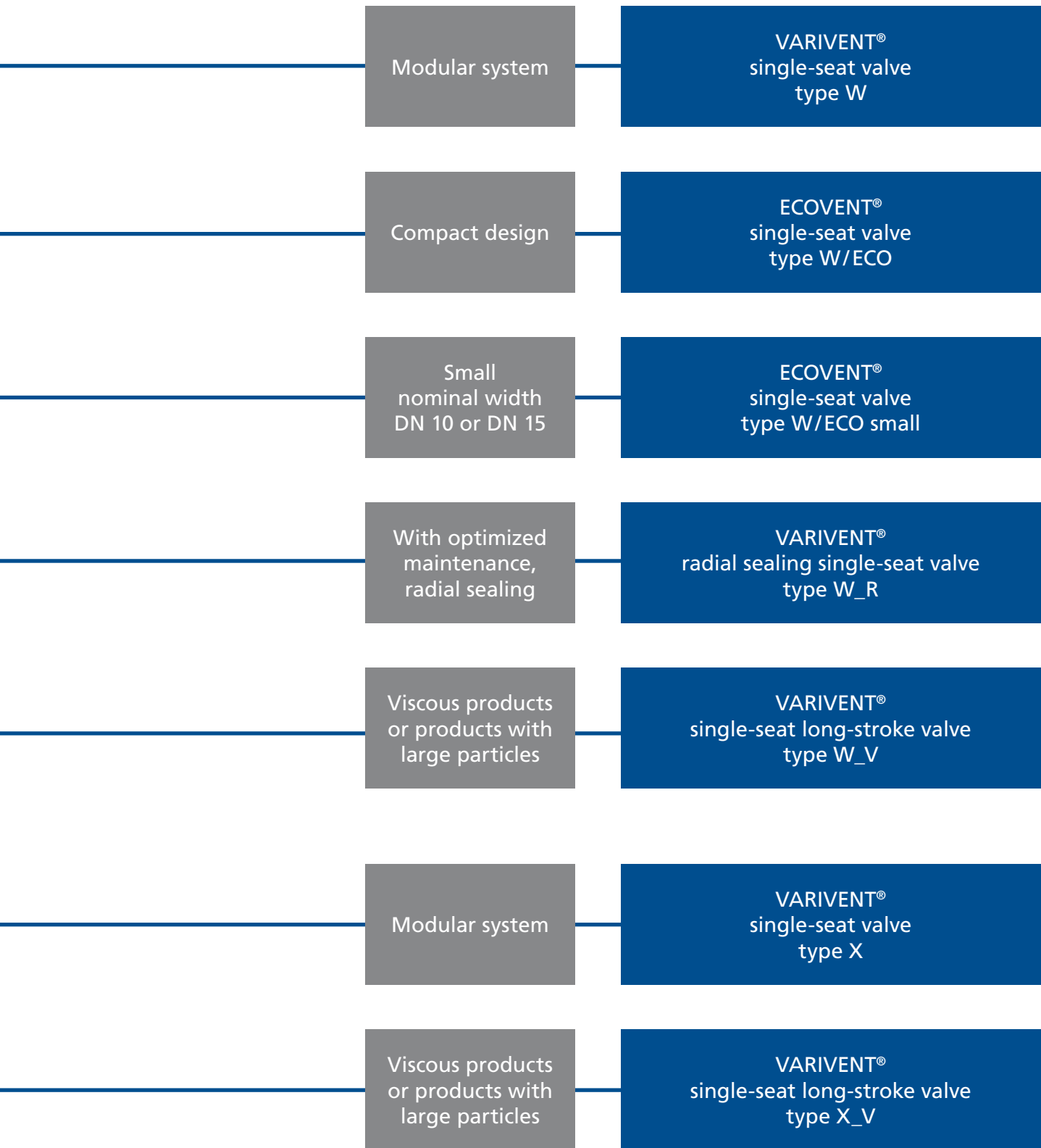





Technical data of the standard version		
Recommended flow direction	Product-merging	
Material in contact with the product	1.4404/AISI 316 L	
Material not in contact with the product	1.4301/AISI 304	
Seal material in contact with the product	EPDM, FKM, HNBR	
Ambient temperature	0 to 45 °C	
Air supply pressure	6 bar (87 psi)	
Product pressure	5 bar (73 psi)	
Surface in contact with the product	DN, OD	Ra ≤ 0.8 µm
	IPS	Ra ≤ 1.2 µm
External housing surface	Matte blasted	
Control and feedback system	Connection 0 (without control top)	
Actuator type	Pneumatic actuator air/spring	
Connection fittings	Welding end	
Identification	Adhesive ID tag	
Valve seat version	Clamped seat ring or fixed vertical port	
Certificates	 	

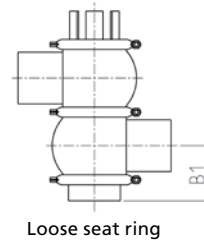
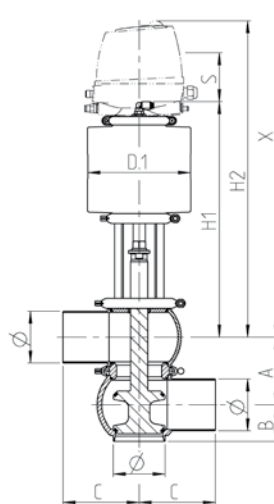

Loose seat ring

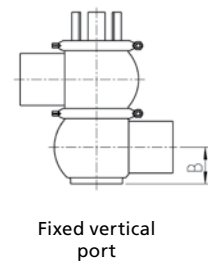

Fixed vertical port

Nominal width	Pipe	Housing				Actuator	Dimensions			Valve	
	Ø [mm]	A [mm]	B [mm]	B1 [mm]	C [mm]	D1 [mm]	H1 [mm]	H2 [mm]	Extension X [mm]	Stroke S [mm]	Weight [kg]
DN 25	29.0 × 1.50	50.0	31	58.0	90	99	294	423	583	11	8
DN 40	41.0 × 1.50	62.0	39	64.0	90	135	335	464	624	25	11
DN 50	53.0 × 1.50	74.0	41	70.0	90	135	341	470	630	25	12
DN 65	70.0 × 2.00	96.0	52	83.0	125	170	382	511	796	25	20
DN 80	85.0 × 2.00	111.0	60	90.5	125	170	390	519	804	25	21
DN 100	104.0 × 2.00	130.0	70	100.0	125	210	399	528	813	25	29
DN 125	129.0 × 2.00	155.0	113	112.0	150	260	555	684	1074	55	57
DN 150	154.0 × 2.00	180.0	125	125.0	150	210	708	837	1227	55	72
OD 1"	25.4 × 1.65	46.0	29	56.0	90	99	292	421	581	7	8
OD 1 ½"	38.1 × 1.65	59.0	39	62.5	90	135	337	466	626	22	11
OD 2"	50.8 × 1.65	71.5	42	69.0	90	135	343	472	632	22	12
OD 2 ½"	63.5 × 1.65	90.0	54	80.0	125	170	386	515	800	19	20
OD 3"	76.2 × 1.65	103.0	54	86.5	125	170	393	522	807	17	20
OD 4"	101.6 × 2.11	127.5	69	99.0	125	210	401	530	815	22	29
OD 6"	152.4 × 2.77	177.0	124	123.5	150	210	707	836	1226	55	72
IPS 2"	60.3 × 2.00	81.0	44	73.5	114.3	135	338	467	627	25	13
IPS 3"	88.9 × 2.30	115.0	63	92.5	152.5	170	388	517	802	25	21
IPS 4"	114.3 × 2.30	140.0	75	105.0	152.5	210	394	523	808	25	30
IPS 6"	168.2 × 2.70	192.0	131	131.0	152.5	210	702	831	1221	55	73

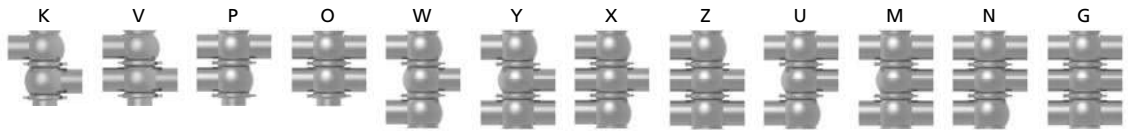
Position	Description of the order code for the standard version												
1	Valve type W VARIVENT® divert valve												
2	Housing combinations 												
3	Supplement to the valve type Reserved for options												
4/5	Nominal width (upper housing / lower housing)												
	DN 25	OD 1"											
	DN 40	OD 1 ½"											
	DN 50	OD 2"	IPS 2"										
	DN 65	OD 2 ½"											
	DN 80	OD 3"	IPS 3"										
	DN 100	OD 4"	IPS 4"										
	DN 125												
	DN 150	OD 6"	IPS 6"										
6	Actuator type S Air/Spring												
7	Non-actuated position Z Spring-to-close (NC) A Spring-to-open (NO)												
8	Standard configuration with 6 bar air supply pressure for 5 bar product pressure (higher pressures on request)												
	Actuator (spring-to-close)	Actuator (spring-to-open)	For nominal widths										
	AA	AA	DN 25, OD 1"										
	CB	CB	DN 40, DN 50, OD 1 ½", OD 2", IPS 2"										
	DD	DD	DN 65, DN 80, OD 2 ½", OD 3", IPS 3"										
	EF	EF	DN 100, OD 4", IPS 4"										
	SH6	SH6	DN 125										
	TK6	TK6	DN 150, OD 6", IPS 6"										
9	Valve seat version (upper housing / lower housing)	Housing combination											
	L0 Loose seat ring/Clamp connection	K	V	P	O	W	Y	X	Z	U	M	N	G
	V0 Fixed vertical port	√	√	√	√	√	√	√	√	√	√	√	√
10	Seal material in contact with the product												
	1 EPDM (FDA)												
	2 FKM (FDA)												
	3 HNBR (FDA); (up to DN 100, OD 4", IPS OD 4")												
11	Surface quality of the housing												
	1 Inside Ra ≤ 1.2 µm, outside matte blasted (IPS)												
	2 Inside Ra ≤ 0.8 µm, outside matte blasted (DN, OD)												
12	Connection fittings												
	N Welding end												
13	Accessories												
	/52 Adhesive ID tag												
+													
14-19	Air connection / Control and feedback system												
	00000M Metric for air hose Ø 6/4 mm												
	00000Z Inch for air hose Ø OD ¼" (6.35/4.35 mm)												
	XXXXX Order code for different control and feedback systems see section 9												

The code is composed as following, depending on the chosen configuration:

Position	1	2	3	4/5	6	7	8	9	10	11	12	13	14 to 19
Code	W			/	S						N	/52	

For order codes differing from the standard version, please refer to section 7 (options).



Technical data of the standard version	
Recommended flow direction	Product-merging
Material in contact with the product	1.4404/AISI 316 L
Material not in contact with the product	1.4301/AISI 304
Seal material in contact with the product	EPDM, FKM, HNBR
Ambient temperature	0 to 45 °C
Air supply pressure	6 bar (87 psi)
Product pressure	5 bar (73 psi)
Surface in contact with the product	Ra ≤ 0.8 µm
External housing surface	Matte blasted
Control and feedback system	Connection 0 (without control top)
Actuator type	Pneumatic actuator air/spring
Connection fittings	Welding end
Identification	Adhesive ID tag
Valve seat version	Clamped seat ring or fixed vertical port
Certificates	

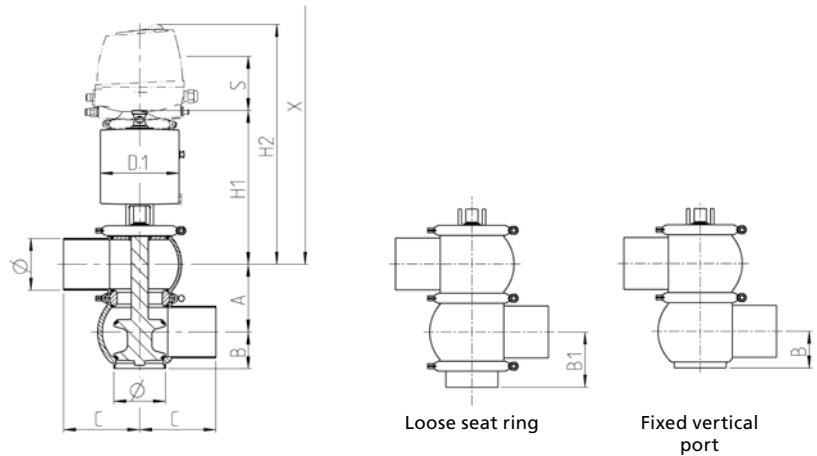

Nominal width	Pipe	Housing				Actuator	Dimensions			Valve	
	Ø [mm]	A [mm]	B [mm]	B1 [mm]	C [mm]	D1 [mm]	H1 [mm]	H2 [mm]	Extension X [mm]	Stroke S [mm]	Weight [kg]
DN 25	29.0 × 1.50	50.0	31	58.0	90	99	209	338	498	15	6
DN 40	41.0 × 1.50	62.0	39	64.0	90	110	243	372	532	24	10
DN 50	53.0 × 1.50	74.0	41	70.0	90	110	249	378	538	24	10
DN 65	70.0 × 2.00	96.0	52	83.0	125	135	257	386	671	26	17
DN 80	85.0 × 2.00	111.0	60	90.5	125	135	264	393	678	26	18
DN 100	104.0 × 2.00	130.0	70	100.0	125	170	274	403	688	26	23
OD 1"	25.4 × 1.65	46.0	29	56.0	90	99	207	336	496	11	6
OD 1 ½"	38.1 × 1.65	59.0	39	62.5	90	110	241	370	530	24	9
OD 2"	50.8 × 1.65	71.5	42	69.0	90	110	248	377	537	24	10
OD 2 ½"	63.5 × 1.65	90.0	54	80.0	125	135	254	383	668	26	18
OD 3"	76.2 × 1.65	103.0	54	86.5	125	135	260	389	674	26	18
OD 4"	101.6 × 2.11	127.5	69	99.0	125	170	273	402	687	26	23

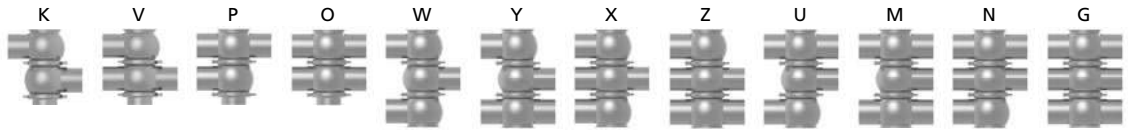
Position	Description of the order code for the standard version																										
1	Valve type W ECOVENT® divert valve																										
2	Housing combinations 																										
3	Supplement to the valve type /ECO																										
4/5	Nominal width (upper housing / lower housing) <table border="1"> <tr><td>DN 25</td><td>OD 1"</td></tr> <tr><td>DN 40</td><td>OD 1 ½"</td></tr> <tr><td>DN 50</td><td>OD 2"</td></tr> <tr><td>DN 65</td><td>OD 2 ½"</td></tr> <tr><td>DN 80</td><td>OD 3"</td></tr> <tr><td>DN 100</td><td>OD 4"</td></tr> </table>												DN 25	OD 1"	DN 40	OD 1 ½"	DN 50	OD 2"	DN 65	OD 2 ½"	DN 80	OD 3"	DN 100	OD 4"			
DN 25	OD 1"																										
DN 40	OD 1 ½"																										
DN 50	OD 2"																										
DN 65	OD 2 ½"																										
DN 80	OD 3"																										
DN 100	OD 4"																										
6	Actuator type E Air/Spring																										
7	Non-actuated position Z Spring-to-close (NC) A Spring-to-open (NO)																										
8	Standard configuration with 6 bar air supply pressure for 5 bar product pressure (higher pressures on request) <table border="1"> <thead> <tr> <th>Actuator (spring-to-close)</th> <th>Actuator (spring-to-open)</th> <th>For nominal widths</th> </tr> </thead> <tbody> <tr> <td>EAA</td> <td>EAA</td> <td>DN 25, OD 1"</td> </tr> <tr> <td>ECB</td> <td>ECB</td> <td>DN 40, DN 50, OD 1 ½", OD 2"</td> </tr> <tr> <td>EDD</td> <td>EDD</td> <td>DN 65, DN 80, OD 2 ½", OD 3"</td> </tr> <tr> <td>EDD*</td> <td>EDD*</td> <td>DN 100, OD 4"</td> </tr> </tbody> </table>												Actuator (spring-to-close)	Actuator (spring-to-open)	For nominal widths	EAA	EAA	DN 25, OD 1"	ECB	ECB	DN 40, DN 50, OD 1 ½", OD 2"	EDD	EDD	DN 65, DN 80, OD 2 ½", OD 3"	EDD*	EDD*	DN 100, OD 4"
Actuator (spring-to-close)	Actuator (spring-to-open)	For nominal widths																									
EAA	EAA	DN 25, OD 1"																									
ECB	ECB	DN 40, DN 50, OD 1 ½", OD 2"																									
EDD	EDD	DN 65, DN 80, OD 2 ½", OD 3"																									
EDD*	EDD*	DN 100, OD 4"																									
9	Valve seat version (upper housing / lower housing)											Housing combination															
	L0	Loose seat ring/Clamp connection										K	V	P	O	W	Y	X	Z	U	M	N	G				
	V0	Fixed vertical port										√	√	√	√	√	√	√	√	√	√	√	√				
10	Seal material in contact with the product 1 EPDM (FDA) 2 FKM (FDA) 3 HNBR (FDA)																										
11	Surface quality of the housing 2 Inside Ra ≤ 0.8 µm, outside matte blasted																										
12	Connection fittings N Welding end																										
13	Accessories /52 Adhesive ID tag																										
+																											
14-19	Air connection / Control and feedback system 00000M Metric for air hose Ø 6/4 mm 00000Z Inch for air hose Ø OD ¼" (6.35/4.35 mm) XXXXX Order code for different control and feedback systems see section 9																										

* with air support

The code is composed as following, depending on the chosen configuration:

Position	1	2	3	4/5	6	7	8	9	10	11	12	13	14 to 19								
Code	W		/ECO	/	E					2	N	/52									

For order codes differing from the standard version, please refer to section 7 (options).



Technical data of the standard version	
Recommended flow direction	Product-merging
Material in contact with the product	1.4404/AISI 316 L
Material not in contact with the product	1.4301/AISI 304
Seal material in contact with the product	EPDM, FKM, HNBR
Ambient temperature	0 to 45 °C
Air supply pressure	5 bar (73 psi)
Product pressure	10 bar (145 psi)
Surface in contact with the product	Ra ≤ 0.8 µm
External housing surface	Matte blasted
Control and feedback system	Connection 0 (without control top)
Actuator type	Pneumatic actuator air/spring
Connection fittings	Welding end
Identification	Adhesive ID tag
Valve seat version	Fixed vertical port
Certificates	

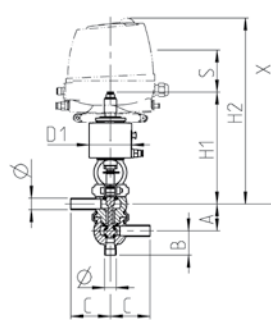

Nominal width	Pipe	Housing			Actuator	Dimensions			Valve	
	Ø [mm]	A [mm]	B [mm]	C [mm]	D1 [mm]	H1 [mm]	H2 [mm]	Extension X [mm]	Stroke S [mm]	Weight [kg]
DN 10	13 × 1.50	44	40	65	70	166	295	345	6	5
DN 15	19 × 1.50	47	40	65	70	169	298	348	6	5

Position	Description of the order code for the standard version
1	Valve type W ECOVENT® divert valve
2	Housing combinations 
3	Supplement to the valve type /ECO
4/5	Nominal width (upper housing / lower housing) DN 10 DN 15
6	Actuator type E Air/Spring
7	Non-actuated position Z Spring-to-close (NC) A Spring-to-open (NO)
8	Standard configuration with 5 bar air supply pressure for 10 bar product pressure (higher pressures on request) Actuator (spring-to-close) 60/4 Actuator (spring-to-open) 60/4
9	Valve seat version (upper housing / lower housing) V0 Fixed vertical port
10	Seal material in contact with the product 1 EPDM (FDA) 2 FKM (FDA) 3 HNBR (FDA)
11	Surface quality of the housing 2 Inside Ra ≤ 0.8 µm, outside matte blasted
12	Connection fittings N Welding end
13	Accessories /52 Adhesive ID tag
+	
14-19	Air connection / Control and feedback system 00000M Metric for air hose Ø 6/4 mm 00000Z Inch for air hose Ø OD ¼" (6.35/4.35 mm) XXXXX Order code for different control and feedback systems see section 9

The code is composed as following, depending on the chosen configuration:

Position	1	2	3	4/5	6	7	8	9	10	11	12	13	14 to 19				
Code	W		/ECO	/	E		60/4	VO		2	N	/52					







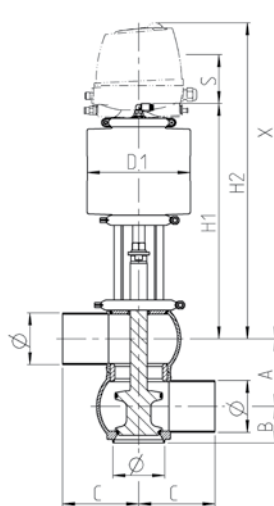



For order codes differing from the standard version, please refer to section 7 (options).



Technical data of the standard version	
Recommended flow direction	Product-merging
Material in contact with the product	1.4404/AISI 316 L
Material not in contact with the product	1.4301/AISI 304
Seal material in contact with the product	EPDM, FKM, HNBR
Ambient temperature	0 to 45 °C
Air supply pressure	6 bar (87 psi)
Product pressure	5 bar (73 psi)
Surface in contact with the product	Ra ≤ 0.8 µm
External housing surface	Matte blasted
Control and feedback system	Connection 0 (without control top)
Actuator type	Pneumatic actuator air/spring
Connection fittings	Welding end
Identification	Adhesive ID tag
Valve seat version	Welded seat ring
Certificates	



Nominal width	Pipe	Housing			Actuator	Dimensions			Valve	
	Ø [mm]	A [mm]	B [mm]	C [mm]	D1 [mm]	H1 [mm]	H2 [mm]	Extension X [mm]	Stroke S [mm]	Weight [kg]
DN 25	29.0 × 1.50	50.0	31	90	99	294	423	583	20	8
DN 40	41.0 × 1.50	62.0	39	90	110	335	464	624	30	11
DN 50	53.0 × 1.50	74.0	41	90	110	341	470	630	30	11
DN 65	70.0 × 2.00	96.0	52	125	135	382	511	796	30	19
DN 80	85.0 × 2.00	111.0	60	125	135	390	519	804	30	20
DN 100	104.0 × 2.00	130.0	70	125	170	399	528	813	30	27
OD 1"	25.4 × 1.65	46.0	29	90	99	292	421	581	20	8
OD 1 ½"	38.1 × 1.65	59.0	39	90	110	337	466	626	27	11
OD 2"	50.8 × 1.65	71.5	42	90	110	343	472	632	28	11
OD 2 ½"	63.5 × 1.65	90.0	54	125	135	386	515	800	25	19
OD 3"	76.2 × 1.65	103.0	54	125	135	393	522	807	30	19
OD 4"	101.6 × 2.11	127.5	69	125	170	401	530	815	28	27

Position	Description of the order code for the standard version		
1	Valve type		
	W	VARIVENT® divert valve	
2	Housing combinations		
			
3	Supplement to the valve type		
	R	Radial sealing	
4/5	Nominal width (upper housing / lower housing)		
	DN 25	OD 1"	
	DN 40	OD 1 ½"	
	DN 50	OD 2"	
	DN 65	OD 2 ½"	
	DN 80	OD 3"	
	DN 100	OD 4"	
6	Actuator type		
	S	Air/Spring	
7	Non-actuated position		
	Z	Spring-to-close (NC)	
	A	Spring-to-open (NO)	
8	Standard configuration with 6 bar air supply pressure for 5 bar product pressure (higher pressures on request)		
	Actuator (spring-to-close)	Actuator (spring-to-open)	For nominal widths
	AA	AA	DN 25, OD 1"
	CB	CB	DN 40, DN 50, OD 1 ½", OD 2"
	DD	DD	DN 65, DN 80, OD 2 ½", OD 3"
	EF	EF	DN 100, OD 4"
9	Valve seat version (upper housing / lower housing)	Housing combination	
		K	P
	V0		
	V1		
	V2		
	V3		
10	Seal material in contact with the product		
	1	EPDM (FDA)	
	2	FKM (FDA)	
	3	HNBR (FDA)	
11	Surface quality of the housing		
	2	Inside Ra ≤ 0.8 µm, outside matte blasted	
12	Connection fittings		
	N	Welding end	
13	Accessories		
	/52	Adhesive ID tag	
+			
14-19	Air connection / Control and feedback system		
	00000M	Metric for air hose Ø 6/4 mm	
	00000Z	Inch for air hose Ø OD ¼" (6.35/4.35 mm)	
	XXXXX	Order code for different control and feedback systems see section 9	

The code is composed as following, depending on the chosen configuration:

Position	1	2	3	4/5	6	7	8	9	10	11	12	13	14 to 19				
Code	W		R	/	S					2	N	/52					

For order codes differing from the standard version, please refer to section 7 (options).



Technical data of the standard version	
Recommended flow direction	Product-merging
Material in contact with the product	1.4404/AISI 316 L
Material not in contact with the product	1.4301/AISI 304
Seal material in contact with the product	EPDM, FKM, HNBR
Ambient temperature	0 to 45 °C
Air supply pressure	6.4 bar (93 psi)
Product pressure	DN 65–DN 80 OD 2 ½" –OD 3" 10 bar (145 psi)
	DN 100 OD 4" 5.2 bar (75 psi)
Surface in contact with the product	Ra ≤ 0.8 µm
External housing surface	Matte blasted
Control and feedback system	Connection 0 (without control top)
Actuator type	Pneumatic actuator air/spring
Connection fittings	Welding end
Identification	Adhesive ID tag
Valve seat version	Clamped seat ring or fixed vertical port
Certificates	

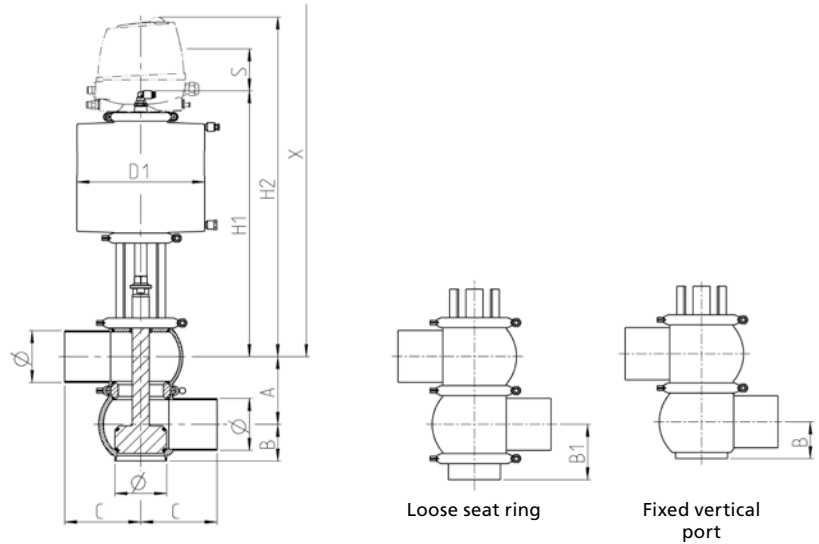

Nominal width	Pipe	Housing				Actuator	Dimensions			Valve	
	Ø [mm]	A [mm]	B [mm]	B1 [mm]	C [mm]	D1 [mm]	H1 [mm]	H2 [mm]	Extension X [mm]	Stroke S [mm]	Weight [kg]
DN 65	70.0 × 2.00	96.0	52	83.0	125	210	421	550	835	50.0	26
DN 80	85.0 × 2.00	111.0	60	90.5	125	210	429	558	843	50.0	28
DN 100	104.0 × 2.00	130.0	70	100.0	125	210	438	567	852	55.0	34
OD 2 ½"	63.5 × 1.65	90.0	54	80.0	125	210	425	554	839	44.0	26
OD 3"	76.2 × 1.65	103.0	54	86.5	125	210	432	561	846	42.0	27
OD 4"	101.6 × 2.11	127.5	69	99.0	125	210	440	569	854	52.5	34

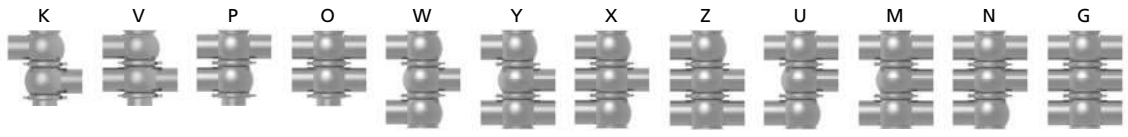
Position	Description of the order code for the standard version													
1	Valve type W VARIVENT® divert valve													
2	Housing combinations 													
3	Supplement to the valve type V Long-stroke													
4/5	Nominal width (upper housing / lower housing) DN 65 OD 2 ½" DN 80 OD 3" DN 100 OD 4"													
6	Actuator type L Air/spring, long stroke													
7	Non-actuated position Z Spring-to-close (NC) A Spring-to-open (NO)													
8	Standard configuration with 6.4 bar air supply pressure for 10 bar (DN 65–DN 80, OD 2 ½"–OD 3") or 5.2 bar (DN 100, OD 4") product pressure, respectively – (higher pressures on request) Actuator (spring-to-close) ZEF/V Actuator (spring-to-open) ZEF/V													
9	Valve seat version (upper housing / lower housing)											Housing combination		
	L0	Loose seat ring/Clamp connection	K	V	P	O	W	Y	X	Z	U	M	N	G
	V0	Fixed vertical port	√	√	√	√	√	√	√	√	√	√	√	√
10	Seal material in contact with the product 1 EPDM (FDA) 2 FKM (FDA) 3 HNBR (FDA)													
11	Surface quality of the housing 2 Inside Ra ≤ 0.8 µm, outside matte blasted													
12	Connection fittings N Welding end													
13	Accessories /52 Adhesive ID tag													
+														
14–19	Air connection / Control and feedback system 00000M Metric for air hose Ø 6/4 mm 00000Z Inch for air hose Ø OD ¼" (6.35/4.35 mm) XXXXXX Order code for different control and feedback systems see section 9													

The code is composed as following, depending on the chosen configuration:

Position	1	2	3	4/5	6	7	8	9	10	11	12	13	14 to 19				
Code	W		V	/	L		ZEF/V			2	N	/52					

For order codes differing from the standard version, please refer to section 7 (options).



Technical data of the standard version		
Recommended flow direction	Product-dividing	
Material in contact with the product	1.4404/AISI 316 L	
Material not in contact with the product	1.4301/AISI 304	
Seal material in contact with the product	EPDM, FKM, HNBR	
Ambient temperature	0 to 45 °C	
Air supply pressure	6 bar (87 psi)	
Product pressure	5 bar (73 psi)	
Surface in contact with the product	DN, OD	Ra ≤ 0.8 µm
	IPS	Ra ≤ 1.2 µm
External housing surface	Matte blasted	
Control and feedback system	Connection 0 (without control top)	
Actuator type	Pneumatic actuator air/spring	
Connection fittings	Welding end	
Identification	Adhesive ID tag	
Valve seat version	Clamped seat ring	
Certificates		

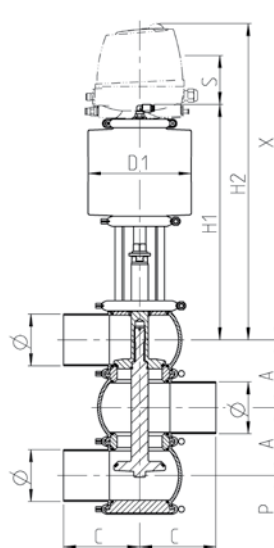

Nominal width	Pipe	Housing		Actuator	Dimensions				Valve	
	Ø [mm]	A [mm]	C [mm]	D1 [mm]	H1 [mm]	H2 [mm]	P [mm]	Extension X [mm]	Stroke S [mm]	Weight [kg]
DN 25	29.0 × 1.50	50.0	90	99	294	423	200	508.00	8	9
DN 40	41.0 × 1.50	62.0	90	110	335	464	200	549.00	13	13
DN 50	53.0 × 1.50	74.0	90	110	341	470	200	555.00	14	14
DN 65	70.0 × 2.00	96.0	125	135	382	511	230	656.00	25	24
DN 80	85.0 × 2.00	111.0	125	135	390	519	230	663.50	25	25
DN 100	104.0 × 2.00	130.0	125	170	399	528	250	673.00	25	34
DN 125	129.0 × 2.00	155.0	150	260	555	684	300	883.50	55	65
DN 150	154.0 × 2.00	180.0	150	260	708	837	300	1037.00	55	82
OD 1"	25.4 × 1.65	46.0	90	99	292	421	200	506.00	7	9
OD 1 ½"	38.1 × 1.65	59.0	90	110	337	466	200	550.50	16	13
OD 2"	50.8 × 1.65	71.5	90	110	343	472	200	556.75	16	13
OD 2 ½"	63.5 × 1.65	90.0	125	135	386	515	230	660.00	25	23
OD 3"	76.2 × 1.65	103.0	125	135	393	522	230	666.50	18	24
OD 4"	101.6 × 2.11	127.5	125	170	401	530	250	674.75	27	33
OD 6"	152.4 × 2.77	177.0	150	260	707	836	300	1035.50	55	82
IPS 2"	60.3 × 2.00	81.0	114.3	110	338	467	200	551.50	20	14
IPS 3"	88.9 × 2.30	115.0	152.5	135	388	517	230	661.50	21	25
IPS 4"	114.3 × 2.30	140.0	152.5	170	394	523	250	668.00	25	35
IPS 6"	168.2 × 2.70	192.0	152.5	260	702	831	300	1031.00	55	84

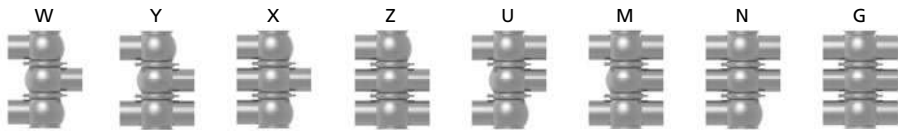
Position	Description of the order code for the standard version																								
1	Valve type X VARIVENT® divert valve																								
2	Housing combinations 																								
3	Supplement to the valve type Reserved for options																								
4/5	Nominal width (upper housing / lower housing) <table border="1"> <tr> <td>DN 25</td> <td>OD 1"</td> <td></td> </tr> <tr> <td>DN 40</td> <td>OD 1 ½"</td> <td></td> </tr> <tr> <td>DN 50</td> <td>OD 2"</td> <td>IPS 2"</td> </tr> <tr> <td>DN 65</td> <td>OD 2 ½"</td> <td></td> </tr> <tr> <td>DN 80</td> <td>OD 3"</td> <td>IPS 3"</td> </tr> <tr> <td>DN 100</td> <td>OD 4"</td> <td>IPS 4"</td> </tr> <tr> <td>DN 125</td> <td></td> <td></td> </tr> <tr> <td>DN 150</td> <td>OD 6"</td> <td>IPS 6"</td> </tr> </table>	DN 25	OD 1"		DN 40	OD 1 ½"		DN 50	OD 2"	IPS 2"	DN 65	OD 2 ½"		DN 80	OD 3"	IPS 3"	DN 100	OD 4"	IPS 4"	DN 125			DN 150	OD 6"	IPS 6"
DN 25	OD 1"																								
DN 40	OD 1 ½"																								
DN 50	OD 2"	IPS 2"																							
DN 65	OD 2 ½"																								
DN 80	OD 3"	IPS 3"																							
DN 100	OD 4"	IPS 4"																							
DN 125																									
DN 150	OD 6"	IPS 6"																							
6	Actuator type S Air/Spring																								
7	Non-actuated position Z Spring-to-close (NC) A Spring-to-open (NO)																								
8	Standard configuration with 6 bar air supply pressure for 5 bar product pressure (higher pressures on request) <table border="1"> <thead> <tr> <th>Actuator (spring-to-close)</th> <th>Actuator (spring-to-open)</th> <th>For nominal widths</th> </tr> </thead> <tbody> <tr> <td>AA</td> <td>AA</td> <td>DN 25, OD 1"</td> </tr> <tr> <td>CB</td> <td>CB</td> <td>DN 40, DN 50, OD 1 ½", OD 2", IPS 2"</td> </tr> <tr> <td>DD</td> <td>DD</td> <td>DN 65, DN 80, OD 2 ½", OD 3", IPS 3"</td> </tr> <tr> <td>EF</td> <td>EF</td> <td>DN 100, OD 4", IPS 4"</td> </tr> <tr> <td>SH6</td> <td>SH6</td> <td>DN 125</td> </tr> <tr> <td>TK6</td> <td>TK6</td> <td>DN 150, OD 6", IPS 6"</td> </tr> </tbody> </table>	Actuator (spring-to-close)	Actuator (spring-to-open)	For nominal widths	AA	AA	DN 25, OD 1"	CB	CB	DN 40, DN 50, OD 1 ½", OD 2", IPS 2"	DD	DD	DN 65, DN 80, OD 2 ½", OD 3", IPS 3"	EF	EF	DN 100, OD 4", IPS 4"	SH6	SH6	DN 125	TK6	TK6	DN 150, OD 6", IPS 6"			
Actuator (spring-to-close)	Actuator (spring-to-open)	For nominal widths																							
AA	AA	DN 25, OD 1"																							
CB	CB	DN 40, DN 50, OD 1 ½", OD 2", IPS 2"																							
DD	DD	DN 65, DN 80, OD 2 ½", OD 3", IPS 3"																							
EF	EF	DN 100, OD 4", IPS 4"																							
SH6	SH6	DN 125																							
TK6	TK6	DN 150, OD 6", IPS 6"																							
9	Valve seat version (upper housing / lower housing) L0 Loose seat ring/Clamp connection																								
10	Seal material in contact with the product 1 EPDM (FDA) 2 FKM (FDA) 3 HNBR (FDA); (up to DN 100, OD 4", IPS OD 4")																								
11	Surface quality of the housing 1 Inside Ra ≤ 1.2 µm, outside matte blasted (IPS) 2 Inside Ra ≤ 0.8 µm, outside matte blasted (DN, OD)																								
12	Connection fittings N Welding end																								
13	Accessories /52 Adhesive ID tag																								
+																									
14-19	Air connection / Control and feedback system 00000M Metric for air hose Ø 6/4 mm 00000Z Inch for air hose Ø OD ¼" (6.35/4.35 mm) XXXXX Order code for different control and feedback systems see section 9																								

The code is composed as following, depending on the chosen configuration:

Position	1	2	3	4/5	6	7	8	9	10	11	12	13	14 to 19
Code	X			/	S			LO			N	/52	

For order codes differing from the standard version, please refer to section 7 (options).



Technical data of the standard version	
Recommended flow direction	Product-dividing
Material in contact with the product	1.4404/AISI 316 L
Material not in contact with the product	1.4301/AISI 304
Seal material in contact with the product	EPDM, FKM, HNBR
Ambient temperature	0 to 45 °C
Air supply pressure	OD 2 ½"–OD 3" 4.8 bar (70 psi)
	OD 4" 6.3 bar (91 psi)
Product pressure	OD 2 ½"–OD 3" 5 bar (73 psi)
	OD 4" 5.2 bar (75 psi)
Surface in contact with the product	Ra ≤ 0.8 µm
External housing surface	Matte blasted
Control and feedback system	Connection 0 (without control top)
Actuator type	Pneumatic actuator air/spring
Connection fittings	Welding end
Identification	Adhesive ID tag
Valve seat version	Clamped seat ring
Certificates	

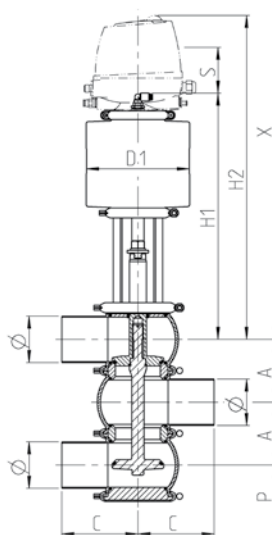

Nominal width	Pipe	Housing		Actuator	Dimensions				Valve	
	Ø [mm]	A [mm]	C [mm]	D1 [mm]	H1 [mm]	H2 [mm]	P [mm]	Extension X [mm]	Stroke S [mm]	Weight [kg]
OD 2 ½"	63.5 × 1.65	90	125	135	396	525	230	670.0	35	24
OD 3"	76.2 × 1.65	103	125	135	403	532	230	676.5	35	24
OD 4"	101.6 × 2.11	127.5	125	210	439	568	280	712.5	55	36

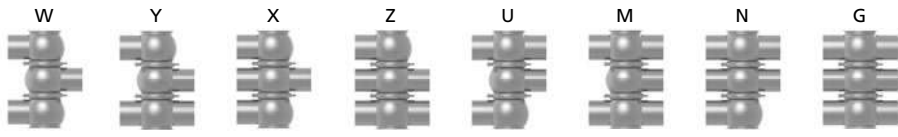
Position	Description of the order code for the standard version									
1	Valve type X VARIVENT® divert valve									
2	Housing combinations 									
3	Supplement to the valve type V Long-stroke									
4/5	Nominal width (upper housing / lower housing) OD 2 ½" OD 3" OD 4"									
6	Actuator type S Air/Spring									
7	Non-actuated position Z Spring-to-close (NC) A Spring-to-open (NO)									
8	Standard configuration with 4.8 bar air supply pressure for 5 bar product pressure (OD 2 ½" – OD 3") or with 6.3 bar air supply pressure for 5.2 bar product pressure (OD 4"), respectively – (higher pressures on request) <table border="1" style="width:100%; border-collapse: collapse;"> <thead> <tr> <th>Actuator (spring-to-close)</th> <th>Actuator (spring-to-open)</th> <th>Nominal width</th> </tr> </thead> <tbody> <tr> <td>DD5</td> <td>DD5</td> <td>OD 2 ½", OD 3"</td> </tr> <tr> <td>ZEF/V</td> <td>ZEF/V</td> <td>OD 4"</td> </tr> </tbody> </table>	Actuator (spring-to-close)	Actuator (spring-to-open)	Nominal width	DD5	DD5	OD 2 ½", OD 3"	ZEF/V	ZEF/V	OD 4"
Actuator (spring-to-close)	Actuator (spring-to-open)	Nominal width								
DD5	DD5	OD 2 ½", OD 3"								
ZEF/V	ZEF/V	OD 4"								
9	Valve seat version (upper housing / lower housing) L0 Loose seat ring/Clamp connection									
10	Seal material in contact with the product 1 EPDM (FDA) 2 FKM (FDA) 3 HNBR (FDA)									
11	Surface quality of the housing 2 Inside Ra ≤ 0.8 µm, outside matte blasted									
12	Connection fittings N Welding end									
13	Accessories /52 Adhesive ID tag									
+										
14–19	Air connection / Control and feedback system 00000M Metric for air hose Ø 6/4 mm 00000Z Inch for air hose Ø OD ¼" (6.35/4.35 mm) XXXXX Order code for different control and feedback systems see section 9									

The code is composed as following, depending on the chosen configuration:

Position	1	2	3	4/5	6	7	8	9	10	11	12	13	14 to 19					
Code	X		V	/	S			L0		2	N	/52						

For order codes differing from the standard version, please refer to section 7 (options).



VARIVENT®

The structure of the VARIVENT® modular system has many optional versions available to best optimize the valve in the process. Please refer to the options section (section 7) for information about these.

VARIVENT® long-stroke valves are used for transporting products with relatively large particles or for viscous products, such as yoghurt with pieces of fruit.

Function of the valve

When the valve is closed (non-actuated position), there are always two seals between the separated pipelines. If one seal is defective, the resulting leakage will be directed through the leakage outlet into the periphery, without mixing with the product in the second pipeline.

This method enables that there is no mixing between the products from two pipelines.

Sizes		
Double-seat valves type D and R	Double-seat valve type B	Double-seat long-stroke valves
DN 25–DN 150	DN 65–DN 150	
OD 1"–OD 6"	OD 2 ½"–OD 6"	OD 3"–OD 4"
IPS2"–IPS 6"	IPS 2"–IPS 6"	

Mixproof separation

VARIVENT® double-seat valves are used for mixproof shut-off of incompatible products at the pipe junctions.

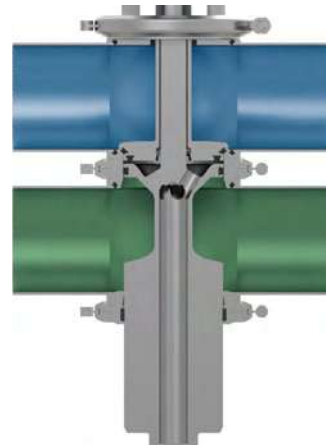
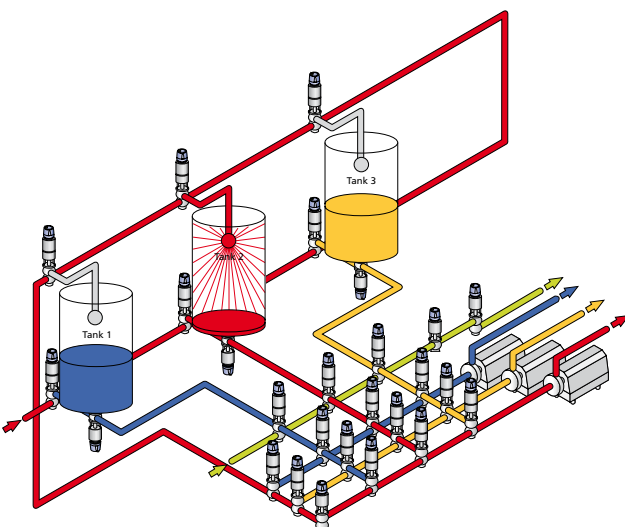

Mixproof separation by two seals



Application examples

To accommodate the different requirements of various industries, applications and processes, we offer mixproof shut-off valves of various technical configurations in our portfolio. The selection matrix provides an overview of all the options.

VARIVENT® double-seat valves with spray cleaning of the leakage chamber are frequently used in non-critical areas:

- Breweries:** Cold process area, e.g. fermenting cellar
- Dairies:** Before heat treatment, e.g. milk reception, raw milk storage...

Special features

Certified, hygienic configuration

Metallic stop

Flexibility because of the modular principle

Proven seal geometry

Mixproof separation

Availability of different valve configurations

Spray cleaning connection for cleaning the leakage chamber

Variety of types

The different variants of the VARIVENT® double-seat valve make it possible to select valves that are optimally adapted to the process.

The axial sealing valve types D and B entail a small switching leakage during each switching procedure, but they notably have a very long service life with the axial seals. The radial sealing valve type R, on the other hand, offers the advantage of switching nearly without any switching leakage.

Valve types B and R are additionally characterized by a balancer in the lower valve housing. This enables the valve to reliably remain in the closed position even if there are water hammers in the lower pipeline.

Switching leakage

In axial sealing double-seat valves, with every switching procedure there is a short time during which the lower valve disc is neither in contact with the middle seal of the upper valve disc, nor has it reached the axial seat surface of the seat ring. During this brief moment liquid can percolate through the resulting gap into the leakage chamber and flow out into the atmosphere. This is referred to as the switching leakage.

In radial sealing double-seat valves, this gap does not occur during the switching procedure, which means the switching leakage is reduced to a minimum (possibility of product residues adhering to the metallic surfaces).

Water hammer safety

If there is a water hammer in the lower pipeline, the force of the water hammer acts on the lower valve disc and could exceed the locking force of the actuator spring.

This gives rise to the danger of the lower valve disc being lifted by the pressure in the pipeline.

In axial sealing double-seat valves, this would result in a connection to the atmosphere, leading to a leak (see switching leakage). The connection to the atmosphere would also cause a sudden reduction in the excess pressure in the pipeline. Then the actuator spring would close the valve again.

Valves with a lower balancer are available to prevent the lower valve disc from lifting during a water hammer in the lower pipeline. With its downward-facing compensation surface, the balancer adjusts out the operating direction of the pressure and prevents movement of the lower valve disc up to a particular excess pressure.

Radial sealing double-seat valves are always equipped with this lower balancer to prevent the opening movement of the lower valve disc.

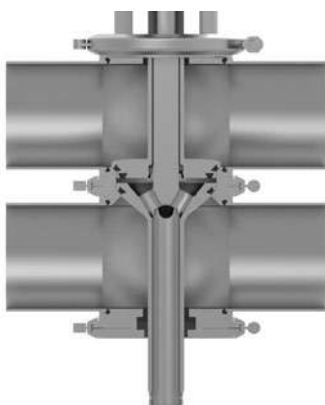

Valve type D

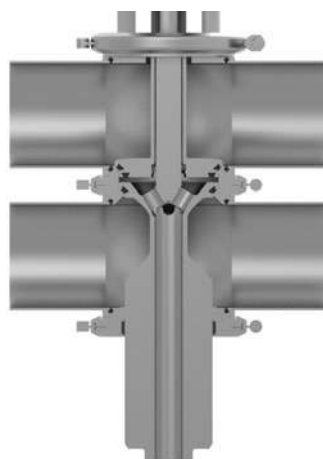

Valve type B

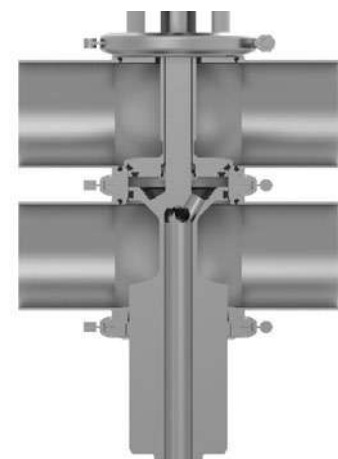

Valve type R

Cleaning the leakage chamber

Spray cleaning

A cleaning connection that is to be connected at the level of the lantern makes it possible to supply external cleaning media into the leakage chamber, in order to clean this chamber using an integrated spray nozzle. After that, the cleaning media flows through the leakage outlet without pressure into the periphery. Cleaning takes place with the valve closed, which means the seal surfaces in contact with the seat ring are not touched during cleaning. In this way, the leakage chamber can be cleaned independently from the pipe cleaning. In addition, this allows interim flushing to occur before or after a switching procedure of the valve.

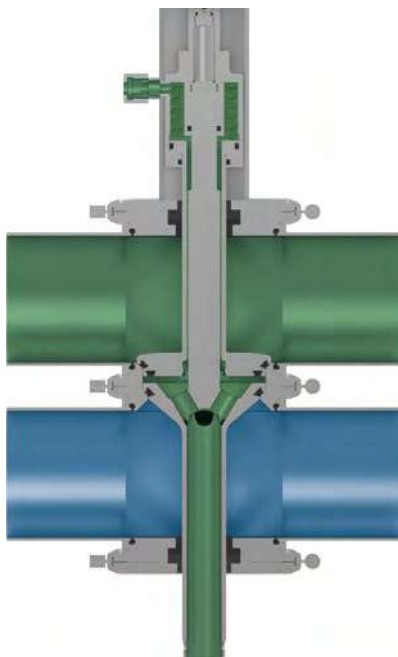

Spray cleaning in the double-seat valve

Periphery

For spray cleaning via the external connection in the lantern, it is necessary to have feed valves in the periphery in order to channel the cleaning media to the cleaning connection at the intended time. For this purpose feed valves with a relatively small nominal width are used on the pipeline carrying the cleaning media. Each feed valve generally supplies several cleaning connections of double-seat valves. It should be noted that all connected double-seat valves must have an adequate supply of cleaning media during cleaning. As a rule of thumb, no more than six double-seat valves should be supplied from one feed valve.

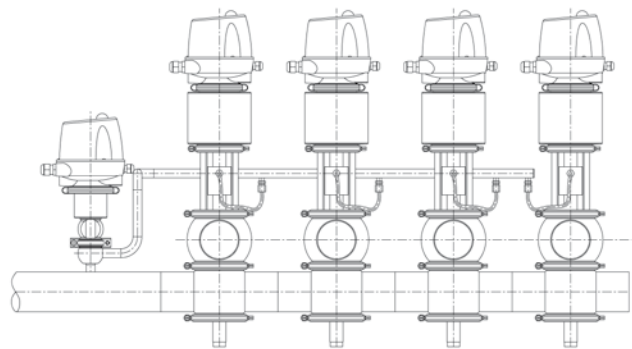

Application example of a feed valve



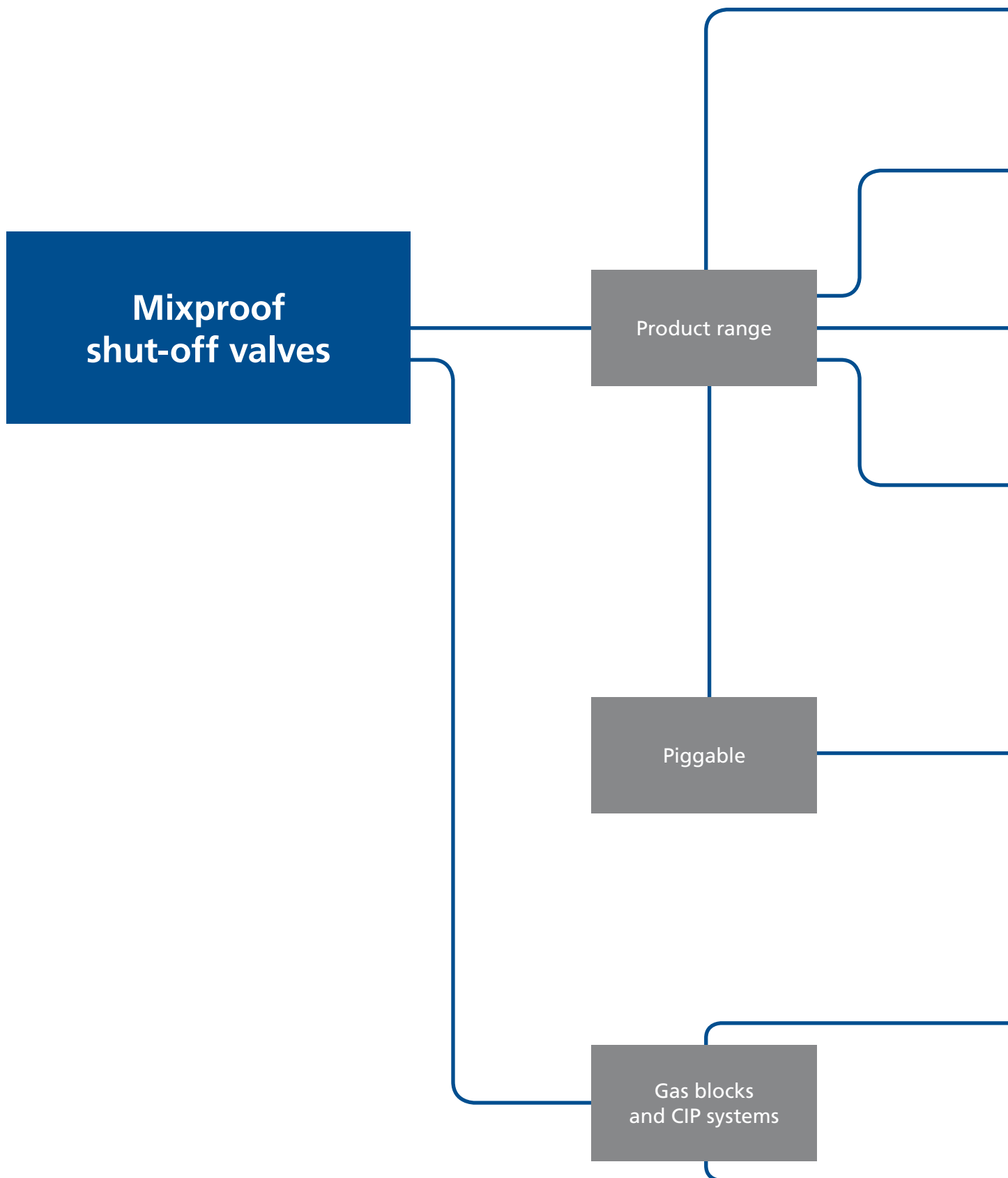

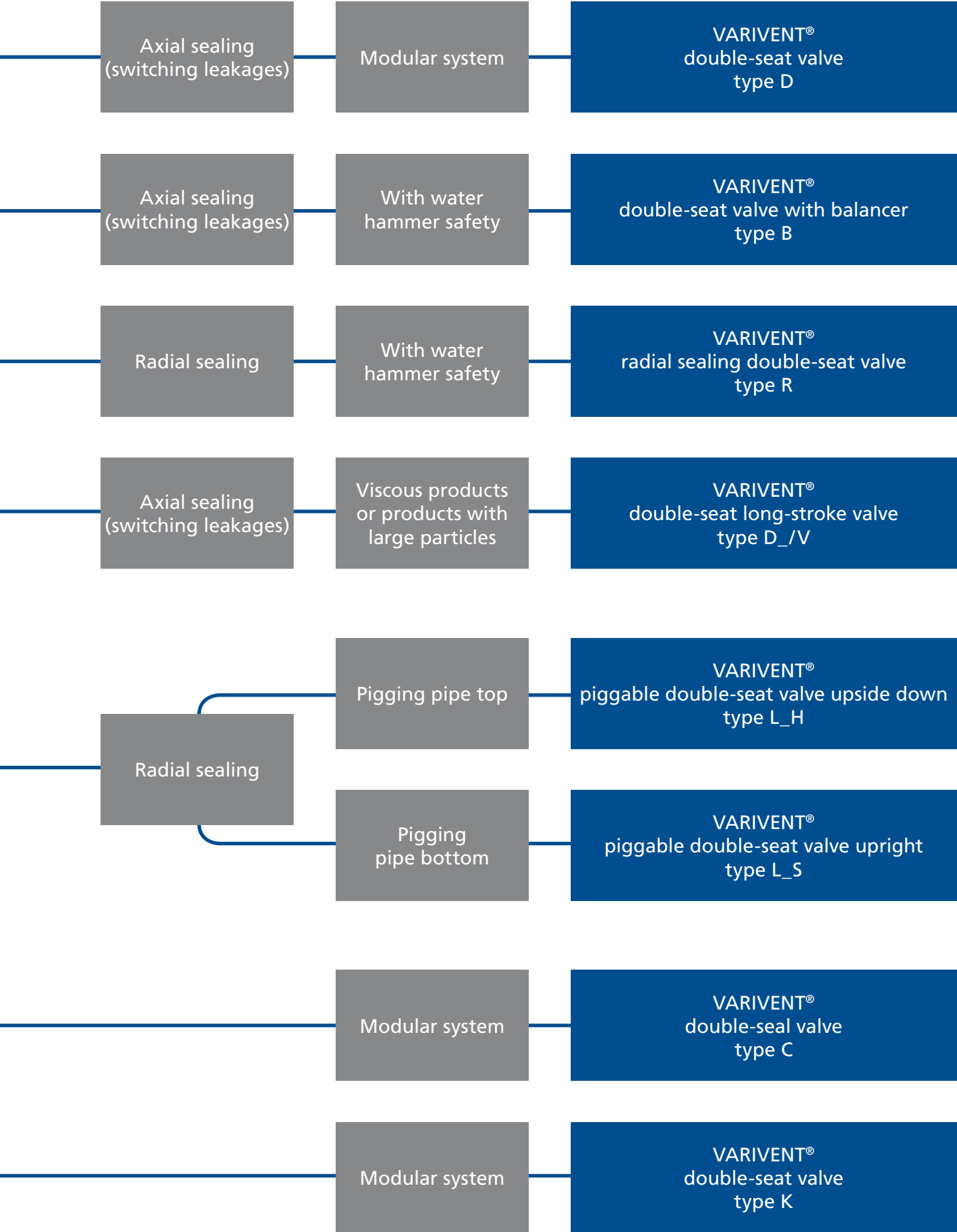





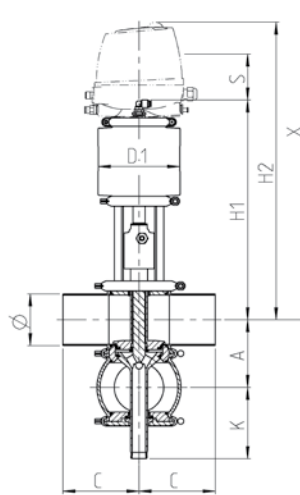



Technical data of the standard version		
Material in contact with the product	1.4404/AISI 316 L	
Material not in contact with the product	1.4301/AISI 304	
Seal material in contact with the product	EPDM, FKM, HNBR	
Ambient temperature	0 to 45 °C	
Air supply pressure	6 bar (87 psi)	
Product pressure	5 bar (73 psi)	
Surface in contact with the product	DN, OD	Ra ≤ 0.8 µm
	IPS	Ra ≤ 1.2 µm
External housing surface	Matte blasted	
Control and feedback system	Connection 0 (without control top)	
Actuator type	Pneumatic actuator air/spring	
Connection fittings	Welding end	
Identification	Adhesive ID tag	
Valve seat version	Clamped or welded seat ring	
Certificates		



		Pipe	Housing			Actuator	Dimensions			Valve	
Nominal width		Ø [mm]	A [mm]	C [mm]	K [mm]	D1 [mm]	H1 [mm]	H2 [mm]	Extension X [mm]	Stroke S [mm]	Weight [kg]
DN 25	25	29.0 x 1.50	50.0	90	81	99	294	423	648	22.0	8
DN 40	40	41.0 x 1.50	62.0	90	93	110	335	464	689	22.0	11
DN 50	50	53.0 x 1.50	74.0	90	99	110	341	470	695	30.0	12
DN 65	65	70.0 x 2.00	96.0	125	125	135	352	481	831	30.0	18
DN 80	80	85.0 x 2.00	111.0	125	117	135	360	489	839	30.0	19
DN 100	100	104.0 x 2.00	130.0	125	137	170	399	528	878	30.0	27
DN 125	125	129.0 x 2.00	155.0	150	171	260	555	684	1174	60.0	58
DN 150	150	154.0 x 2.00	180.0	150	196	260	579	708	1198	60.0	66
OD 1"	1"	25.4 x 1.65	46.0	90	83	99	292	421	646	18.0	8
OD 1 1/2"	1 1/2"	38.1 x 1.65	59.0	90	94	110	337	466	691	22.0	11
OD 2"	2"	50.8 x 1.65	71.5	90	100	110	343	472	697	30.5	11
OD 2 1/2"	2 1/2"	63.5 x 1.65	90.0	125	128	135	356	485	835	31.0	18
OD 3"	3"	76.2 x 1.65	103.0	125	121	135	363	492	842	29.0	18
OD 4"	4"	101.6 x 2.11	127.5	125	138	170	401	530	880	30.5	27
OD 6"	6"	152.4 x 2.77	177.0	150	197	260	578	707	1197	60.0	67
IPS 2"	2"	60.3 x 2.00	81.0	114.3	95	110	338	467	692	30.0	12
IPS 3"	3"	88.9 x 2.30	115.0	152.5	115	135	358	487	837	30.0	19
IPS 4"	4"	114.3 x 2.30	140.0	152.5	132	170	394	523	873	30.0	28
IPS 6"	6"	168.2 x 2.70	192.0	152.5	190	260	573	702	1192	60.0	68

Please note: A 10–100 mm clearance below the leakage outlet is required with this valve type.

Position	Description of the order code for the standard version			
1	Valve type			
	D VARIVENT® double-seat valve			
2	Housing combinations			
				
3	Supplement to the valve type			
	Reserved for options			
4/5	Nominal width (upper housing / lower housing)			
	DN 25	OD 1"		
	DN 40	OD 1 ½"		
	DN 50	OD 2"	IPS 2"	
	DN 65	OD 2 ½"		
	DN 80	OD 3"	IPS 3"	
	DN 100	OD 4"	IPS 4"	
	DN 125			
	DN 150	OD 6"	IPS 6"	
6	Actuator type			
	S Air/Spring			
7	Non-actuated position			
	Z Spring-to-close (NC)			
8	Standard configuration with 6 bar air supply pressure for 5 bar product pressure (higher pressures on request)			
	Actuator (spring-to-close)		For nominal widths	
	AA		DN 25, OD 1"	
	BB		DN 40, DN 50, OD 1 ½", OD 2", IPS 2"	
	CD		DN 65, DN 80, OD 2 ½", OD 3", IPS 3"	
	DF		DN 100, OD 4", IPS 4"	
	SH6		DN 125	
	SK6		DN 150, OD 6", IPS 6"	
9	Valve seat version (upper housing / lower housing)		Housing combination	
	L0	Loose seat ring/Clamp connection	A	B
			√	√
	V1	Welded seat ring/ Port orientation 90°		
	V2	Welded seat ring/ Port orientation 180°		
	V3	Welded seat ring/ Port orientation 270°		
10	Seal material in contact with the product			
	1	EPDM (FDA)		
	2	FKM (FDA)		
	3	HNBR (FDA); (up to DN 100, OD 4", IPS OD 4")		
11	Surface quality of the housing			
	1	Inside Ra ≤ 1.2 µm, outside matte blasted (IPS)		
	2	Inside Ra ≤ 0.8 µm, outside matte blasted (DN, OD)		
12	Connection fittings			
	N	Welding end		
13	Accessories			
	/52	Adhesive ID tag		
+				
14-19	Air connection / Control and feedback system			
	00000M	Metric for air hose Ø 6/4 mm		
	00000Z	Inch for air hose Ø OD ¼" (6.35/4.35 mm)		
	XXXXX	Order code for different control and feedback systems see section 9		

The code is composed as following, depending on the chosen configuration:

Position	1	2	3	4/5	6	7	8	9	10	11	12	13	14 to 19
Code	D			/	S	Z					N	/52	

For order codes differing from the standard version, please refer to section 7 (options).





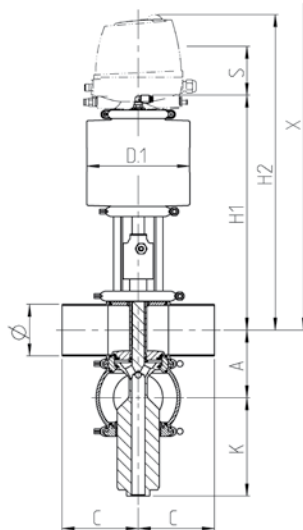









Technical data of the standard version		
Material in contact with the product	1.4404/AISI 316 L	
Material not in contact with the product	1.4301/AISI 304	
Seal material in contact with the product	EPDM, FKM, HNBR	
Ambient temperature	0 to 45 °C	
Air supply pressure	6 bar (87 psi)	
Product pressure	5 bar (73 psi)	
Water hammer safety	Up to 25 bar	
Surface in contact with the product	DN, OD	Ra ≤ 0.8 µm
	IPS	Ra ≤ 1.2 µm
External housing surface	Matte blasted	
Control and feedback system	Connection 0 (without control top)	
Actuator type	Pneumatic actuator air/spring	
Connection fittings	Welding end	
Identification	Adhesive ID tag	
Valve seat version	Clamped or welded seat ring	
Certificates		



Nominal width	Pipe		Housing			Actuator	Dimensions			Valve	
		Ø [mm]	A [mm]	C [mm]	K [mm]	D1 [mm]	H1 [mm]	H2 [mm]	Extension X [mm]	Stroke S [mm]	Weight [kg]
DN 65	70.0 × 2.00	96.0	125	125.0	170	382	511	916	30.0	24	
DN 80	85.0 × 2.00	111.0	125	117.0	170	390	519	924	30.0	24	
DN 100	104.0 × 2.00	130.0	125	137.0	210	399	528	933	30.0	32	
DN 125	129.0 × 2.00	155.0	150	171.0	210	555	684	1274	60.0	51	
DN 150	154.0 × 2.00	180.0	150	196.0	260	579	708	1298	60.0	65	
OD 2 ½"	63.5 × 1.65	90.0	125	128.0	170	386	515	920	31.0	23	
OD 3"	76.2 × 1.65	103.0	125	121.0	170	393	522	927	29.0	24	
OD 4"	101.6 × 2.11	127.5	125	138.0	210	401	530	935	30.5	32	
OD 6"	152.4 × 2.77	177.0	150	276.5	260	578	707	1297	60.0	66	
IPS 2"	60.3 × 2.00	81.0	114.3	95.0	110	345	474	734	30.0	13	
IPS 3"	88.9 × 2.30	115.0	152.5	115.0	170	392	521	926	30.0	25	
IPS 4"	114.3 × 2.30	140.0	152.5	132.0	210	404	533	938	30.0	33	
IPS 6"	168.2 × 2.70	192.0	152.5	190.0	260	573	702	1292	60.0	67	

Please note: A 10–100 mm clearance below the leakage outlet is required with this valve type.

Position	Description of the order code for the standard version					
1	Valve type					
	B VARIVENT® double-seat valve					
2	Housing combinations					
						
3	Supplement to the valve type					
	Reserved for options					
4/5	Nominal width (upper housing / lower housing)					
	DN 65	OD 2 ½"	IPS 2"			
	DN 80	OD 3"	IPS 3"			
	DN 100	OD 4"	IPS 4"			
	DN 125					
	DN 150	OD 6"	IPS 6"			
6	Actuator type					
	S Air/Spring					
7	Non-actuated position					
	Z Spring-to-close (NC)					
8	Standard configuration with 6 bar air supply pressure for 5 bar product pressure (higher pressures on request)					
	Actuator (spring-to-close)		For nominal widths			
	BB		IPS 2"			
	DD		DN 65, DN 80, OD 2 ½", OD 3", IPS 3"			
	EF		DN 100, OD 4", IPS 4"			
	EF6		DN 125			
	SG6		DN 150, OD 6", IPS 6"			
9	Valve seat version (upper housing / lower housing)		Housing combination			
	L0	Loose seat ring/Clamp connection	A ✓	B ✓	C ✓	E ✓
	V1	Welded seat ring/ Port orientation 90°				
	V2	Welded seat ring/ Port orientation 180°				
	V3	Welded seat ring/ Port orientation 270°				
10	Seal material in contact with the product					
	1 EPDM (FDA)					
	2 FKM (FDA)					
	3 HNBR (FDA); (up to DN 100, OD 4", IPS OD 4")					
11	Surface quality of the housing					
	1 Inside Ra ≤ 1.2 µm, outside matte blasted (IPS)					
	2 Inside Ra ≤ 0.8 µm, outside matte blasted (DN, OD)					
12	Connection fittings					
	N Welding end					
13	Accessories					
	/52 Adhesive ID tag					
+						
14-19	Air connection / Control and feedback system					
	00000M Metric for air hose Ø 6/4 mm					
	00000Z Inch for air hose Ø OD ¼" (6.35/4.35 mm)					
	XXXXX Order code for different control and feedback systems see section 9					

The code is composed as following, depending on the chosen configuration:

Position	1	2	3	4/5	6	7	8	9	10	11	12	13	14 to 19		
Code	B			/	S	Z					N	/52			

For order codes differing from the standard version, please refer to section 7 (options).







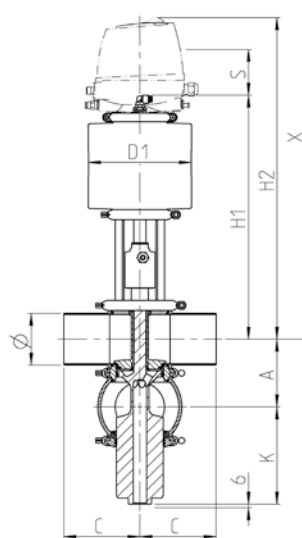



Technical data of the standard version	
Material in contact with the product	1.4404/AISI 316 L
Material not in contact with the product	1.4301/AISI 304
Seal material in contact with the product	EPDM, FKM, HNBR
Ambient temperature	0 to 45 °C
Air supply pressure	6 bar (87 psi)
Product pressure	5 bar (73 psi)
Water hammer safety	30 bar (up to DN 50, OD 2", IPS 2") 50 bar (from DN 65, OD 2 1/2", IPS 3")
Surface in contact with the product	DN, OD Ra ≤ 0.8 µm
	IPS Ra ≤ 1.2 µm
External housing surface	Matte blasted
Control and feedback system	Connection 0 (without control top)
Actuator type	Pneumatic actuator air/spring
Connection fittings	Welding end
Identification	Adhesive ID tag
Valve seat version	Clamped or welded seat ring
Certificates	

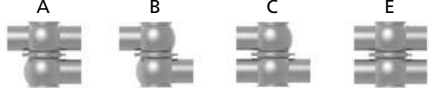

Nominal width	Pipe		Housing			Actuator	Dimensions			Valve	
		Ø [mm]	A [mm]	C [mm]	K [mm]	D1 [mm]	H1 [mm]	H2 [mm]	Extension X [mm]	Stroke S [mm]	Weight [kg]
DN 25	29.0 × 1.50	29.0	50.0	90	91.0	135	329.0	458.0	718	22	11
DN 40	41.0 × 1.50	41.0	62.0	90	129.5	135	338.0	467.0	727	25	14
DN 50	53.0 × 1.50	53.0	74.0	90	135.5	135	341.0	470.0	730	30	14
DN 65	70.0 × 2.00	70.0	96.0	125	164.5	170	382.0	511.0	916	30	24
DN 80	85.0 × 2.00	85.0	111.0	125	172.0	170	399.5	528.5	934	40	26
DN 100	104.0 × 2.00	104.0	130.0	125	192.5	170	409.0	538.0	943	40	29
DN 125	129.0 × 2.00	129.0	155.0	150	258.0	210	554.5	683.5	1274	60	52
DN 150	154.0 × 2.00	154.0	180.0	150	272.5	210	661.0	790.0	1380	60	64
OD 1"	25.4 × 1.65	25.4	46.0	90	93.0	135	327.0	456.0	716	18	11
OD 1 1/2"	38.1 × 1.65	38.1	59.0	90	128.0	135	336.5	465.5	726	22	14
OD 2"	50.8 × 1.65	50.8	71.5	90	137.0	135	343.0	472.0	732	30	14
OD 2 1/2"	63.5 × 1.65	63.5	90.0	125	167.5	170	386.0	515.0	920	31	24
OD 3"	76.2 × 1.65	76.2	103.0	125	176.0	170	402.5	531.5	937	39	25
OD 4"	101.6 × 2.11	101.6	127.5	125	194.0	170	411.0	540.0	945	40	31
OD 6"	152.4 × 2.77	152.4	177.0	150	274.0	210	659.5	788.5	1379	60	65
IPS 2"	60.3 × 2.00	60.3	81.0	114.3	139	135	344.5	473.5	734	29	15
IPS 3"	88.9 × 2.30	88.9	115.0	152.5	174	170	401.5	530.5	936	40	26
IPS 4"	114.3 × 2.30	114.3	140.0	152.5	197.5	170	414.0	543.0	948	40	31
IPS 6"	168.2 × 2.70	168.2	192.0	152.5	278.5	210	655.0	784.0	1374	60	66

Please note: A 10–100 mm clearance below the leakage outlet is required with this valve type.

Position	Description of the order code for the standard version			
1	Valve type			
	R VARIVENT® double-seat valve, radial sealing			
2	Housing combinations			
				
3	Supplement to the valve type			
	Reserved for options			
4/5	Nominal width (upper housing / lower housing)			
	DN 25	OD 1"		
	DN 40	OD 1 ½"		
	DN 50	OD 2"	IPS 2"	
	DN 65	OD 2 ½"		
	DN 80	OD 3"	IPS 3"	
	DN 100	OD 4"	IPS 4"	
	DN 125			
	DN 150	OD 6"	IPS 6"	
6	Actuator type			
	S Air/Spring			
7	Non-actuated position			
	Z Spring-to-close (NC)			
8	Standard configuration with 6 bar air supply pressure for 5 bar product pressure (higher pressures on request)			
	Actuator (spring-to-close)		For nominal widths	
	CD		DN 25, DN 40, DN 50, OD 1", OD 1 ½", OD 2", IPS 2"	
	DD		DN 65, OD 2 ½"	
	DD5		DN 80, DN 100, OD 3", OD 4", IPS 3", IPS 4"	
	EF6		DN 125	
	RF6		DN 150, OD 6", IPS 6"	
9	Valve seat version (upper housing / lower housing)		Housing combination	
	L0	Loose seat ring/Clamp connection	A	B
			✓	✓
	V1	Welded seat ring/ Port orientation 90°		
	V2	Welded seat ring/ Port orientation 180°		
	V3	Welded seat ring/ Port orientation 270°		
10	Seal material in contact with the product			
	1	EPDM (FDA)		
	2	FKM (FDA)		
	3	HNBR (FDA); (up to DN 100, OD 4", IPS OD 4")		
11	Surface quality of the housing			
	1	Inside Ra ≤ 1.2 µm, outside matte blasted (IPS)		
	2	Inside Ra ≤ 0.8 µm, outside matte blasted (DN, OD)		
12	Connection fittings			
	N	Welding end		
13	Accessories			
	/52	Adhesive ID tag (up to DN 50, OD 2", IPS 2")		
	/52/05	Adhesive ID tag (from DN 65, OD 2 ½", IPS 3")		
+				
14-19	Air connection/Control and feedback system			
	00000M	Metric for air hose Ø 6/4 mm		
	00000Z	Inch for air hose Ø OD ¼" (6.35/4.35 mm)		
	XXXXX	Order code for different control and feedback systems see section 9		

The code is composed as following, depending on the chosen configuration:

Position	1	2	3	4/5	6	7	8	9	10	11	12	13	14 to 19
Code	R			/	S	Z					N	/52/05	+

For order codes differing from the standard version, please refer to section 7 (options).





Technical data of the standard version	
Material in contact with the product	1.4404/AISI 316 L
Material not in contact with the product	1.4301/AISI 304
Seal material in contact with the product	EPDM, FKM, HNBR
Ambient temperature	0 to 45 °C
Air supply pressure	6 bar (87 psi)
Product pressure	5 bar (73 psi)
Surface in contact with the product	Ra ≤ 0.8 µm
External housing surface	Matte blasted
Control and feedback system	Connection 0 (without control top)
Actuator type	Pneumatic actuator air/spring
Connection fittings	Welding end
Identification	Adhesive ID tag
Valve seat version	Clamped or welded seat ring
Certificates	

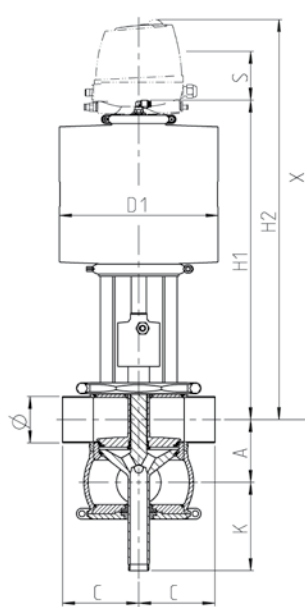

Nominal width	Pipe		Housing			Actuator	Dimensions			Valve	
	Ø [mm]	A [mm]	C [mm]	K [mm]	D1 [mm]	H1 [mm]	H2 [mm]	Extension X [mm]	Stroke S [mm]	Weight [kg]	
OD 3"	76.2 × 1.65	103.0	150	145	261	528.50	657.50	1007.50	60	53	
OD 4"	101.6 × 2.11	127.5	150	157	261	540.75	669.75	1019.75	60	61	

Please note: A 10–100 mm clearance below the leakage outlet is required with this valve type.

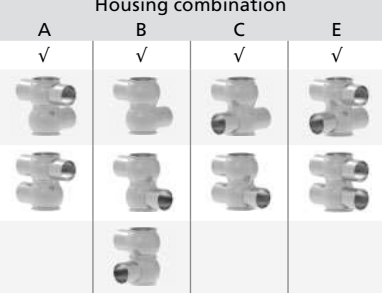
Position	Description of the order code for the standard version	
1	Valve type D VARIVENT® double-seat valve	
2	Housing combinations 	
3	Supplement to the valve type /V Long-stroke	
4/5	Nominal width (upper housing / lower housing) OD 3" OD 4"	
6	Actuator type S Air/Spring	
7	Non-actuated position Z Spring-to-close (NC)	
8	Standard configuration with 6 bar air supply pressure for 5 bar product pressure (higher pressures on request)	
	Actuator (spring-to-close) SH6 SK6	For nominal widths OD 3" OD 4"
9	Valve seat version (upper housing / lower housing) L0 Loose seat ring/Clamp connection V1 Welded seat ring/ Port orientation 90° V2 Welded seat ring/ Port orientation 180° V3 Welded seat ring/ Port orientation 270°	Housing combination A B C E 
10	Seal material in contact with the product 1 EPDM (FDA) 2 FKM (FDA) 3 HNBR (FDA)	
11	Surface quality of the housing 2 Inside Ra ≤ 0.8 µm, outside matte blasted	
12	Connection fittings N Welding end	
13	Accessories /52 Adhesive ID tag	
+		
14-19	Air connection / Control and feedback system 00000M Metric for air hose Ø 6/4 mm 00000Z Inch for air hose Ø OD ¼" (6.35/4.35 mm) XXXXXX Order code for different control and feedback systems see section 9	

The code is composed as following, depending on the chosen configuration:

Position	1	2	3	4/5	6	7	8	9	10	11	12	13	14 to 19					
Code	D		/V	/	S	Z				2	N	/52						

For order codes differing from the standard version, please refer to section 7 (options).





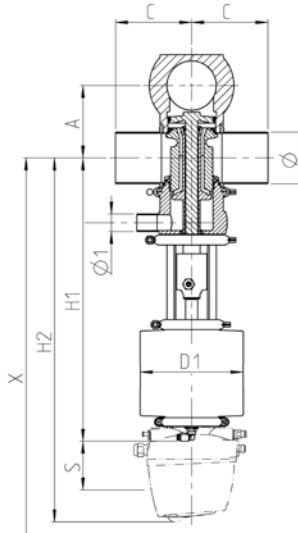

Technical data of the standard version	
Material in contact with the product	1.4404/AISI 316 L
Material not in contact with the product	1.4301/AISI 304
Seal material in contact with the product	EPDM, FKM, HNBR
Ambient temperature	0 to 45 °C
Air supply pressure	6 bar (87 psi)
Product pressure	7 bar (101 psi)
Surface in contact with the product	Ra ≤ 0.8 µm
External housing surface	Matte blasted
Control and feedback system	Connection 0 (without control top)
Actuator type	Pneumatic actuator air/spring
Connection fittings	Welding end
Identification	Adhesive ID tag
Valve seat version	Welded seat ring
Certificates	

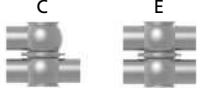

	Pipe	Pipe leakage	Housing		Actuator	Dimensions			Valve	
Nominal width	Ø [mm]	Ø1 [mm]	A [mm]	C [mm]	D1 [mm]	H1 [mm]	H2 [mm]	Extension X [mm]	Stroke S [mm]	Weight [kg]
DN 40	41.0 × 1.50	23 × 1.5	74.0	90	135	414.5	543.5	648.5	25	16
DN 50	53.0 × 1.50	23 × 1.5	86.0	90	135	420.5	549.5	654.5	33	16
DN 65	70.0 × 2.00	29 × 1.5	104.0	125	170	460.5	589.5	764.5	35	29
DN 80	85.0 × 2.00	29 × 1.5	119.0	125	170	468.0	597.0	772.0	35	29
DN 100	104.0 × 2.00	29 × 1.5	138.0	125	210	467.5	596.5	771.5	35	43
OD 1 ½"	38.1 × 1.65	23 × 1.5	71.0	90	135	416.0	545.0	650.0	25	16
OD 2"	50.8 × 1.65	23 × 1.5	83.5	90	135	422.3	551.3	656.3	33	16
OD 2 ½"	63.5 × 1.65	29 × 1.5	98.0	125	170	464.5	593.5	768.5	35	28
OD 3"	76.2 × 1.65	29 × 1.5	111.0	125	170	471.0	600.0	775.0	35	29
OD 4"	101.6 × 2.11	29 × 1.5	135.5	125	210	469.3	598.3	773.3	35	43

Position	Description of the order code for the standard version											
1	Valve type L VARIVENT® double-seat valve, piggable											
2	Housing combinations 											
3	Supplement to the valve type H Upside down											
4/5	Nominal width (upper housing / lower housing) <table border="1"> <tr><td>DN 40</td><td>OD 1 ½"</td></tr> <tr><td>DN 50</td><td>OD 2"</td></tr> <tr><td>DN 65</td><td>OD 2 ½"</td></tr> <tr><td>DN 80</td><td>OD 3"</td></tr> <tr><td>DN 100</td><td>OD 4"</td></tr> </table>		DN 40	OD 1 ½"	DN 50	OD 2"	DN 65	OD 2 ½"	DN 80	OD 3"	DN 100	OD 4"
DN 40	OD 1 ½"											
DN 50	OD 2"											
DN 65	OD 2 ½"											
DN 80	OD 3"											
DN 100	OD 4"											
6	Actuator type S Air/Spring											
7	Non-actuated position Z Spring-to-close (NC)											
8	Standard configuration with 6 bar air supply pressure for 7 bar product pressure (higher pressures on request)											
	Actuator (spring-to-close) CD DF EG	For nominal widths DN 40, DN 50, OD 1 ½", OD 2" DN 65, DN 80, OD 2 ½", OD 3" DN 100, OD 4"										
9	Valve seat version (upper housing / lower housing) V1 Welded seat ring/ Port orientation 90°	Housing combination C  E 										
10	Seal material in contact with the product 1 EPDM (FDA) 2 FKM (FDA) 3 HNBR (FDA)											
11	Surface quality of the housing 2 Inside Ra ≤ 0.8 µm, outside matte blasted											
12	Connection fittings N Welding end											
13	Accessories /52 Adhesive ID tag											
+												
14-19	Air connection / Control and feedback system 00000M Metric for air hose Ø 6/4 mm 00000Z Inch for air hose Ø OD ¼" (6.35/4.35 mm) XXXXXX Order code for different control and feedback systems see section 9											

The code is composed as following, depending on the chosen configuration:

Position	1	2	3	4/5	6	7	8	9	10	11	12	13	14 to 19
Code	L		H	/	S	Z		V1		2	N	/52	

For order codes differing from the standard version, please refer to section 7 (options).





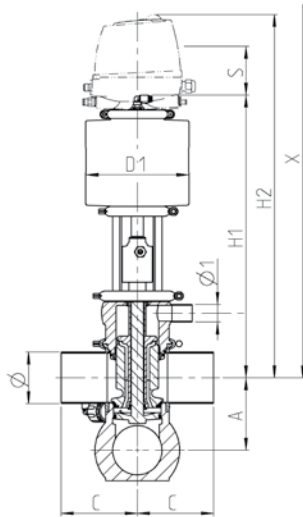

Technical data of the standard version	
Material in contact with the product	1.4404/AISI 316 L
Material not in contact with the product	1.4301/AISI 304
Seal material in contact with the product	EPDM, FKM, HNBR
Ambient temperature	0 to 45 °C
Air supply pressure	6 bar (87 psi)
Product pressure	7 bar (101 psi)
Surface in contact with the product	Ra ≤ 0.8 µm
External housing surface	Matte blasted
Control and feedback system	Connection 0 (without control top)
Actuator type	Pneumatic actuator air/spring
Connection fittings	Welding end
Identification	Adhesive ID tag
Valve seat version	Welded seat ring
Certificates	

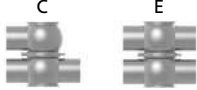

Nominal width	Pipe		Pipe leakage		Housing		Actuator		Dimensions			Valve	
	DN	Ø [mm]	Ø1 [mm]	A [mm]	C [mm]	D1 [mm]	H1 [mm]	H2 [mm]	Extension X [mm]	Stroke S [mm]	Weight [kg]		
DN 40	41.0 × 1.50	23 × 1.5	74.0	90	135	414.5	543.5	648.5	25	16			
DN 50	53.0 × 1.50	23 × 1.5	86.0	90	135	420.5	549.5	654.5	33	17			
DN 65	70.0 × 2.00	29 × 1.5	104.0	125	170	460.5	589.5	764.5	35	29			
DN 80	85.0 × 2.00	29 × 1.5	119.0	125	170	468.0	597.0	772.0	35	30			
DN 100	104.0 × 2.00	29 × 1.5	138.0	125	210	467.5	596.5	771.5	35	38			
OD 1 ½"	38.1 × 1.65	23 × 1.5	71.0	90	135	416.0	545.0	650.0	25	16			
OD 2"	50.8 × 1.65	23 × 1.5	83.5	90	135	422.3	551.3	656.3	33	17			
OD 2 ½"	63.5 × 1.65	29 × 1.5	98.0	125	170	464.5	593.5	768.5	35	28			
OD 3"	76.2 × 1.65	29 × 1.5	111.0	125	170	471.0	600.0	775.0	35	29			
OD 4"	101.6 × 2.11	29 × 1.5	135.5	125	210	469.3	598.3	773.3	35	38			

Position	Description of the order code for the standard version											
1	Valve type L VARIVENT® double-seat valve, piggable											
2	Housing combinations 											
3	Supplement to the valve type S Upright											
4/5	Nominal width (upper housing / lower housing) <table border="1"> <tr><td>DN 40</td><td>OD 1 ½"</td></tr> <tr><td>DN 50</td><td>OD 2"</td></tr> <tr><td>DN 65</td><td>OD 2 ½"</td></tr> <tr><td>DN 80</td><td>OD 3"</td></tr> <tr><td>DN 100</td><td>OD 4"</td></tr> </table>		DN 40	OD 1 ½"	DN 50	OD 2"	DN 65	OD 2 ½"	DN 80	OD 3"	DN 100	OD 4"
DN 40	OD 1 ½"											
DN 50	OD 2"											
DN 65	OD 2 ½"											
DN 80	OD 3"											
DN 100	OD 4"											
6	Actuator type S Air/Spring											
7	Non-actuated position Z Spring-to-close (NC)											
8	Standard configuration with 6 bar air supply pressure for 7 bar product pressure (higher pressures on request)											
	Actuator (spring-to-close) CD DF EG	For nominal widths DN 40, DN 50, OD 1 ½", OD 2" DN 65, DN 80, OD 2 ½", OD 3" DN 100, OD 4"										
9	Valve seat version (upper housing / lower housing) V1 Welded seat ring/ Port orientation 90°	Housing combination C  E 										
10	Seal material in contact with the product 1 EPDM (FDA) 2 FKM (FDA) 3 HNBR (FDA)											
11	Surface quality of the housing 2 Inside Ra ≤ 0.8 µm, outside matte blasted											
12	Connection fittings N Welding end											
13	Accessories /52 Adhesive ID tag											
+												
14-19	Air connection / Control and feedback system 00000M Metric for air hose Ø 6/4 mm 00000Z Inch for air hose Ø OD ¼" (6.35/4.35 mm) XXXXXX Order code for different control and feedback systems see section 9											

The code is composed as following, depending on the chosen configuration:

Position	1	2	3	4/5	6	7	8	9	10	11	12	13	14 to 19
Code	L		S	/	S	Z				2	N	/52	

For order codes differing from the standard version, please refer to section 7 (options).





VARIVENT®

The VARIVENT® modular system has many available versions for optimizing the valves in the process system. Please refer to the options section (section 7) for information about these.

Sizes	
Double-seat valves type C	Double-seat valves type K
DN 25 – DN 150	DN 25 – DN 150
OD 1" – OD 6"	OD 1" – OD 6"
	IPS 2" – IPS 6"

Application examples

VARIVENT® double-seat valves type C and double-seat valves type K are predominantly used in areas where hygiene is not critical, e.g. CIP systems and gas blocks (brewery).

Mixproof separation

VARIVENT® mixproof valves type C and K are used as efficient alternatives for mixproof separation of incompatible products at pipeline junctions within CIP systems or gas blocks.

When the valve is closed (non-actuated position), there are always two seals between the separated pipelines. If one seal is defective, the resulting leakage will be directed through the leakage outlet into the periphery, without mixing with the product in the second pipeline.

The valve types

Valve type K represents a typical double-seat valve with two independent valve discs in which these two seals are located.

Valve type C, on the other hand, is a double-seat valve in which these two seals are together with the leakage chamber in between them in a valve disc.



Double-seat valve type K



Double-seat valve type C

In both versions, two seals prevent any mixture between a product line and a line carrying a cleaning media.



Cleaning the leakage chamber

Double-seat valve type C

In the standard version, two flushing valves are connected to the leakage chamber between the two valve disc seals. One flushing valve is always used for the leakage outlet, while the second flushing valve is in contact with cleaning media through an olive screw fitting, in order to clean the leakage chamber.

In this case, it is necessary to have a supply valve connected in the periphery to supply the flushing valve with cleaning media at the required time.

Cleaning takes place while the main valve is closed, which means the seal surfaces of the valve disc seals that are in contact are not reached.

Double-seat valve type K

The double-seat valve type K does not have either an external spraying connection nor a lifting actuator. The leakage chamber is flushed by the fluid that emerges from the leakage chamber as a result of the switching leakage during the main stroke. For this reason, the valve is not suitable for use in hygienic areas.

The advantages of the valve type K are its slightly increased safety against water hammers that could occur in the lower pipeline, as well as having a wider selection of available housing combinations.

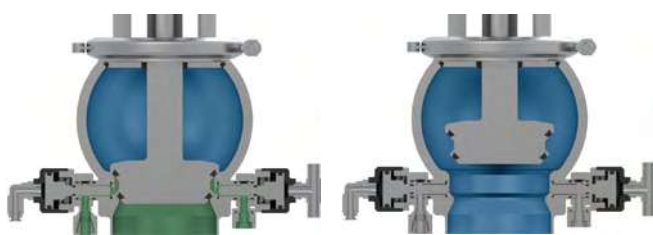

Valve closed, cleaning of the leakage chamber

Valve open, flushing valves closed



Arrangement of the flushing valves





Detection of leakage with only one flushing valve



Switching leakage



Technical data of the standard version	
Material in contact with the product	1.4404/AISI 316 L
Material not in contact with the product	1.4301/AISI 304
Seal material in contact with the product	EPDM, FKM, HNBR
Ambient temperature	0 to 45 °C
Air supply pressure	6 bar (87 psi)
Product pressure	5 bar (73 psi)
Surface in contact with the product	Ra ≤ 0.8 µm
External housing surface	Matte blasted
Control and feedback system	Connection 0 (without control top)
Actuator type	Pneumatic actuator air/spring
Connection fittings	Welding end
Identification	Adhesive ID tag
Valve seat version	Fixed vertical port
Certificates	 

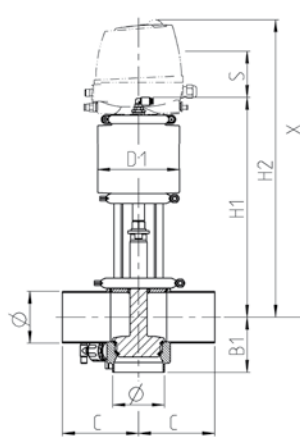

Nominal width	Pipe		Housing		Actuator	Dimensions			Valve	
	DN	Ø [mm]	B1 [mm]	C [mm]	D1 [mm]	H1 [mm]	H2 [mm]	Extension X [mm]	Stroke S [mm]	Weight [kg]
DN 25	29.0 × 1.50	58	90	99	294	423	528	16	8	
DN 40	41.0 × 1.50	64	90	110	338	467	572	14	10	
DN 50	53.0 × 1.50	70	90	110	341	470	575	26	10	
DN 65	70.0 × 2.00	83	125	135	352	481	656	30	15	
DN 80	85.0 × 2.00	91	125	135	360	489	664	30	16	
DN 100	104.0 × 2.00	100	125	170	399	528	703	30	23	
DN 125	129.0 × 2.00	113	150	260	555	684	914	60	49	
DN 150	154.0 × 2.00	125	150	260	579	708	938	60	55	
OD 1"	25.4 × 1.65	56	90	135	292	421	526	12	8	
OD 1 ½"	38.1 × 1.65	63	90	135	337	466	571	14	10	
OD 2"	50.8 × 1.65	69	90	135	343	472	577	27	10	
OD 2 ½"	63.5 × 1.65	80	125	170	356	485	660	31	15	
OD 3"	76.2 × 1.65	87	125	170	363	492	667	29	15	
OD 4"	101.6 × 2.11	99	125	170	401	530	705	30	22	

Position	Description of the order code for the standard version																
1	Valve type C VARIVENT® double-seal valve																
2	Housing combinations 																
3	Supplement to the valve type Reserved for options																
4/5	Nominal width (upper housing / lower housing) <table border="1"> <tr><td>DN 25</td><td>OD 1"</td></tr> <tr><td>DN 40</td><td>OD 1 ½"</td></tr> <tr><td>DN 50</td><td>OD 2"</td></tr> <tr><td>DN 65</td><td>OD 2 ½"</td></tr> <tr><td>DN 80</td><td>OD 3"</td></tr> <tr><td>DN 100</td><td>OD 4"</td></tr> <tr><td>DN 125</td><td></td></tr> <tr><td>DN 150</td><td></td></tr> </table>	DN 25	OD 1"	DN 40	OD 1 ½"	DN 50	OD 2"	DN 65	OD 2 ½"	DN 80	OD 3"	DN 100	OD 4"	DN 125		DN 150	
DN 25	OD 1"																
DN 40	OD 1 ½"																
DN 50	OD 2"																
DN 65	OD 2 ½"																
DN 80	OD 3"																
DN 100	OD 4"																
DN 125																	
DN 150																	
6	Actuator type S Air/Spring																
7	Non-actuated position Z Spring-to-close (NC)																
8	Standard configuration with 6 bar air supply pressure for 5 bar product pressure (higher pressures on request) <table border="1"> <thead> <tr> <th>Actuator (spring-to-close)</th> <th>For nominal widths</th> </tr> </thead> <tbody> <tr><td>AA</td><td>DN 25, OD 1"</td></tr> <tr><td>BB</td><td>DN 40, DN 50, OD 1 ½", OD 2"</td></tr> <tr><td>CD</td><td>DN 65, DN 80, OD 2 ½", OD 3"</td></tr> <tr><td>DF</td><td>DN 100, OD 4"</td></tr> <tr><td>SH6</td><td>DN 125</td></tr> <tr><td>SK6</td><td>DN 150</td></tr> </tbody> </table>	Actuator (spring-to-close)	For nominal widths	AA	DN 25, OD 1"	BB	DN 40, DN 50, OD 1 ½", OD 2"	CD	DN 65, DN 80, OD 2 ½", OD 3"	DF	DN 100, OD 4"	SH6	DN 125	SK6	DN 150		
Actuator (spring-to-close)	For nominal widths																
AA	DN 25, OD 1"																
BB	DN 40, DN 50, OD 1 ½", OD 2"																
CD	DN 65, DN 80, OD 2 ½", OD 3"																
DF	DN 100, OD 4"																
SH6	DN 125																
SK6	DN 150																
9	Valve seat version (upper housing / lower housing) V0 Fixed vertical port																
10	Seal material in contact with the product 1 EPDM (FDA) 2 FKM (FDA) 3 HNBR (FDA); (up to DN 100)																
11	Surface quality of the housing 2 Inside Ra ≤ 0.8 µm, outside matte blasted																
12	Connection fittings N Welding end																
13	Accessories /52 Adhesive ID tag																
+																	
14–19	Air connection / Control and feedback system 00000M Metric for air hose Ø 6/4 mm 00000Z Inch for air hose Ø OD ¼" (6.35/4.35 mm) XXXXX Order code for different control and feedback systems see section 9																

The code is composed as following, depending on the chosen configuration:

Position	1	2	3	4/5	6	7	8	9	10	11	12	13	14 to 19
Code	C			/	S	Z		V0		2	N	/52	







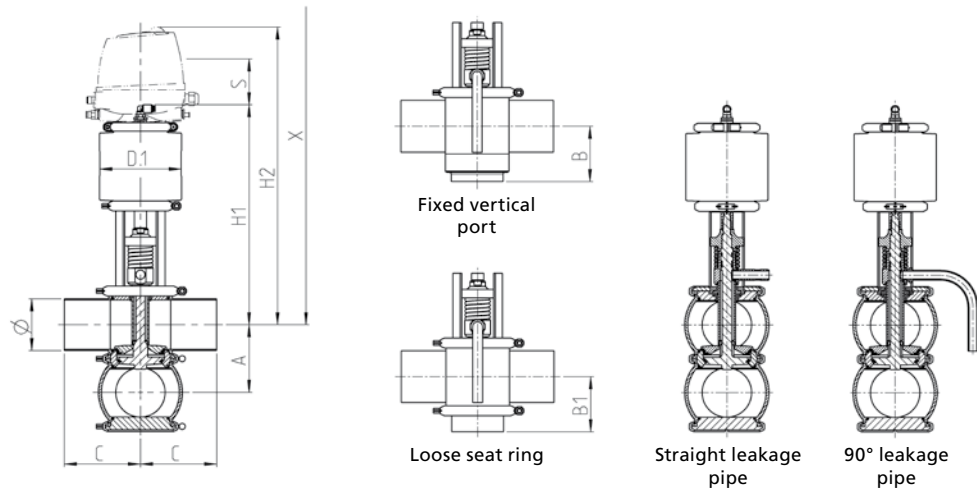



For order codes differing from the standard version, please refer to section 7 (options).



Technical data of the standard version		
Material in contact with the product	1.4404/AISI 316 L	
Material not in contact with the product	1.4301/AISI 304	
Seal material in contact with the product	EPDM, FKM, HNBR	
Ambient temperature	0 to 45 °C	
Air supply pressure	6 bar (87 psi)	
Product pressure	5 bar (73 psi)	
Surface in contact with the product	DN, OD	Ra ≤ 0.8 µm
	IPS	Ra ≤ 1.2 µm
External housing surface	Matte blasted	
Control and feedback system	Connection 0 (without control top)	
Actuator type	Pneumatic actuator air/spring	
Connection fittings	Welding end	
Identification	Adhesive ID tag	
Valve seat version	Clamped or welded seat ring	
Certificates		



Nominal width	Pipe		Housing				Actuator	Dimensions			Valve	
	Ø [mm]	A [mm]	B [mm]	B1 [mm]	C [mm]	D1 [mm]	H1 [mm]	H2 [mm]	Extension X [mm]	Stroke S [mm]	Weight [kg]	
DN 25	29.0 × 1.50	50.0	31.0	58.0	90	135	329.0	458.0	563	22	9	
DN 40	41.0 × 1.50	62.0	39.0	64.0	90	135	338.0	467.0	572	25	11	
DN 50	53.0 × 1.50	74.0	41.0	70.0	90	135	341.0	470.0	575	30	11	
DN 65	70.0 × 2.00	96.0	52.0	83.0	125	170	382.0	511.0	686	30	18	
DN 80	85.0 × 2.00	111.0	60.0	90.5	125	170	399.5	528.5	704	40	18	
DN 100	104.0 × 2.00	130.0	70.0	100.0	125	170	409.0	538.0	713	40	26	
DN 125	129.0 × 2.00	155.0	112.0	113.0	150	210	554.5	683.5	914	60	57	
DN 150	154.0 × 2.00	180.0	125.0	125.0	150	210	661.0	790.0	1020	60	65	
OD 1"	25.4 × 1.65	46.0	29.0	56.0	90	135	327.0	456.0	561	18	9	
OD 1 ½"	38.1 × 1.65	59.0	39.0	62.5	90	135	336.5	465.5	571	22	11	
OD 2"	50.8 × 1.65	71.5	42.0	69.0	90	135	343.0	472.0	577	30	11	
OD 2 ½"	63.5 × 1.65	90.0	54.0	80.0	125	170	386.0	515.0	690	30	17	
OD 3"	76.2 × 1.65	103.0	54.0	86.5	125	170	402.5	531.5	707	39	18	
OD 4"	101.6 × 2.11	127.5	69.0	99.0	125	170	411.0	540.0	715	40	26	
OD 6"	152.4 × 2.77	177.0	123.5	123.5	150	210	659.5	788.5	1019	60	66	
IPS 2"	60.3 × 2.00	81.0	44.0	73.5	114.3	135	344.5	473.5	579	29	12	
IPS 3"	88.9 × 2.30	115.0	63.0	92.5	152.5	170	401.5	530.5	706	40	19	
IPS 4"	114.3 × 2.30	140.0	75.0	105.0	152.5	170	414.0	543.0	718	40	27	
IPS 6"	168.2 × 2.70	192.0	131.0	131.0	152.5	210	655.0	784.0	1014	60	67	

Position	Description of the order code for the standard version						
1	Valve type K VARIVENT® double-seat valve						
2	Housing combinations A B C E L T 						
3	Supplement to the valve type Reserved for options						
4/5	Nominal width (upper housing / lower housing)						
	DN 25	OD 1"					
	DN 40	OD 1 ½"				IPS 2"	
	DN 50	OD 2"					
	DN 65	OD 2 ½"					
	DN 80	OD 3"				IPS 3"	
	DN 100	OD 4"				IPS 4"	
	DN 125						
	DN 150	OD 6"				IPS 6"	
6	Actuator type S Air/Spring						
7	Non-actuated position Z Spring-to-close (NC)						
8	Standard configuration with 6 bar air supply pressure for 5 bar product pressure (higher pressures on request)						
	Actuator (spring-to-close)			For nominal widths			
	AA			DN 25, OD 1"			
	BB			DN 40, DN 50, OD 1 ½", OD 2", IPS 2"			
	CD			DN 65, DN 80, OD 2 ½", OD 3", IPS 3"			
	DF			DN 100, OD 4", IPS 4"			
	SH6			DN 125			
	SK6			DN 150, OD 6", IPS 6"			
9	Valve seat version (upper housing / lower housing)			Housing combination			
	L0	Loose seat ring/Clamp connection	√	√	√	√	√
	V0	Fixed vertical port				√	√
	V1	Welded seat ring/ Port orientation 90°					
	V2	Welded seat ring/ Port orientation 180°					
	V3	Welded seat ring/ Port orientation 270°					
10	Seal material in contact with the product						
	1	EPDM (FDA)					
	2	FKM (FDA)					
	3	HNBR (FDA); (up to DN 100, OD 4", IPS OD 4")					
11	Surface quality of the housing						
	1	Inside Ra ≤ 1.2 µm, outside matte blasted (IPS)					
	2	Inside Ra ≤ 0.8 µm, outside matte blasted (DN, OD)					
12	Connection fittings						
	N	Welding end					
13	Accessories						
	/52	Adhesive ID tag					
	/K1	Straight leakage pipe					
	/K2	90° leakage pipe					
+							
14-19	Air connection / Control and feedback system						
	00000M	Metric for air hose Ø 6/4 mm					
	00000Z	Inch for air hose Ø OD ¼" (6.35/4.35 mm)					
	XXXXX	Order code for different control and feedback systems see section 9					

The code is composed as following, depending on the chosen configuration:

Position	1	2	3	4/5	6	7	8	9	10	11	12	13	14 to 19						
Code	K			/	S	Z					N	/52							

For order codes differing from the standard version, please refer to section 7 (options).





VARIVENT®

The structure of the VARIVENT® modular system means that many options are available. Please refer to the options section (section 7) for information about these.

VARIVENT® long-stroke valves are used for manufacturing products with relatively large particles or for viscous products, such as strawberry yoghurt.

Sizes		
Double-seat valves type D and R	Double-seat valve type B	Double-seat long-stroke valves
DN 25–DN 150	DN 65–DN 150	
OD 1"–OD 6"	OD 2 ½"–OD 6"	OD 3"–OD 4"
IPS2"–IPS 6"	IPS 2"–IPS 6"	

Function of the valve

When the valve is closed (non-actuated position), there are always two seals between the separated pipelines. If one seal is defective, the resulting leakage will be directed through the leakage outlet into the periphery, without mixing with the product in the second pipeline.

This method enables that there is no mixing between the products from two pipelines.

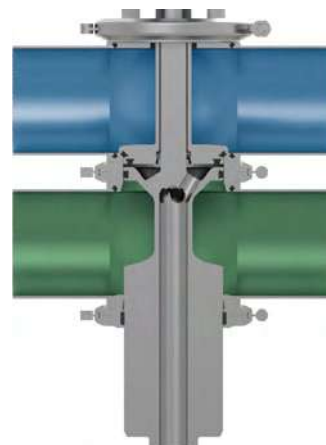

Mixproof separation by two seals

Mixproof separation

VARIVENT® double-seat valves are used for mixproof shut-off of incompatible fluids at pipe junctions.

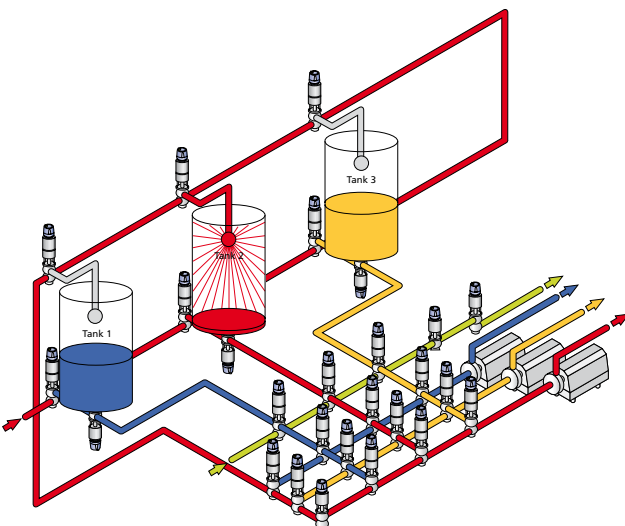



Application examples

To accommodate the different requirements of various industries, applications and processes, we have a variety of mixproof shut-off valves in our portfolio. The selection matrix provides an overview of all the options.

Special features
Certified hygienic configuration
Metallic stop
Flexibility because of the modular principle
Proven seal geometry
Mixproof separation
Different valve configurations available
Separate lifting actuator for lifting both valve discs
Optional spray cleaning connection for cleaning the leakage chamber



Variety of types

The different variants of the VARIVENT® double-seat valve make it possible to select valves that are optimally adapted to the process.

The axial sealing valve types D and B entail a small switching leakage during each switching procedure, but they notably have a very long service life with the axial seals. The radial sealing valve type R, on the other hand, offers the advantage of switching nearly without any switching leakage.

Valve types B and R are additionally characterized by a balancer in the lower valve housing. This enables the valve to reliably remain in the closed position even if there are water hammers in the lower pipeline.

Switching leakage

In axial sealing double-seat valves, with every switching procedure there is a short time during which the lower valve disc is neither in contact with the middle seal of the upper valve disc, nor has it reached the axial seat surface of the seat ring. During this brief moment liquid can percolate through the resulting gap into the leakage chamber and flow out into the atmosphere. This is referred to as the switching leakage.

In radial sealing double-seat valves, this gap does not occur during the switching procedure, which means the switching leakage is reduced to a minimum (possibility of product residues adhering to the metallic surfaces).

Water hammer safety

If there is a water hammer in the lower pipeline, the force of the water hammer acts on the lower valve disc and could exceed the locking force of the actuator spring.

This gives rise to the danger of the lower valve disc being lifted by the pressure in the pipeline.

In axial sealing double-seat valves, this would result in a connection to the atmosphere, leading to a leak (see switching leakage). The connection to the atmosphere would also cause a sudden reduction in the excess pressure in the pipeline. Then the actuator spring would close the valve again.

Valves with a lower balancer are available to prevent the lower valve disc from lifting during a water hammer in the lower pipeline. With its downward-facing compensation surface, the balancer adjusts out the operating direction of the pressure and prevents movement of the lower valve disc up to a particular excess pressure.

Radial sealing double-seat valves are always equipped with this lower balancer to prevent the opening movement of the lower valve disc.

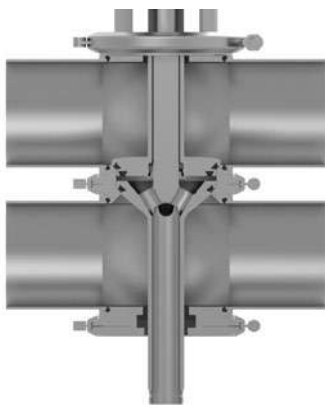

Valve type D

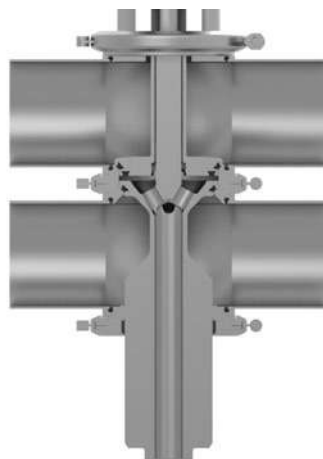

Valve type B

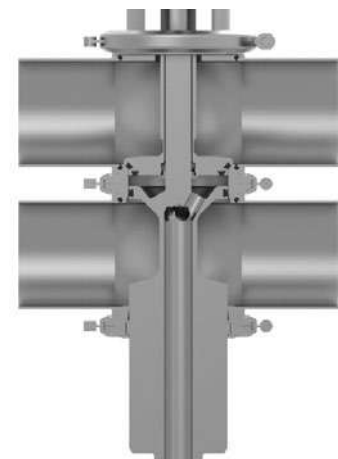

Valve type R

Cleaning the leakage chamber

Lifting actuator

Double-seat valves are equipped with a lifting actuator which permits individual lifting of each valve disc during the particular pipe cleaning.

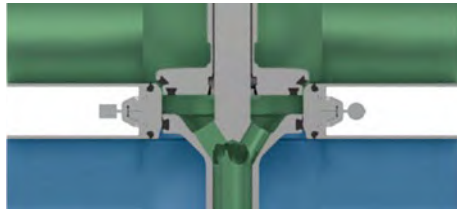

If there is cleaning media in the upper pipeline, the upper valve disc can be lifted to allow the surface of the seal and the leakage chamber to be cleaned.

In this case, the cleaning media passes the seal of the lifted valve disc, cleans the leakage chamber and then flows out through the leakage outlet into the periphery. This way it is possible to clean all surfaces that come into contact with the product, including the surfaces of the valve disc seals.

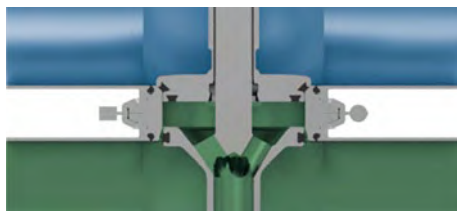

In the radial sealed double-seat valve type R, the lower valve disc opens downward.

If there is cleaning media in the lower pipeline, double-seat valve type D and B permit lifting of the lower valve disc upwards.

Spray cleaning

A cleaning connection that is to be connected at the level of the lantern makes it possible to supply external cleaning media into the leakage chamber, so to clean this chamber or to carry out an additional intermediate flushing before or after a switching procedure. After that, the cleaning media flows through the leakage outlet without pressure into the periphery.

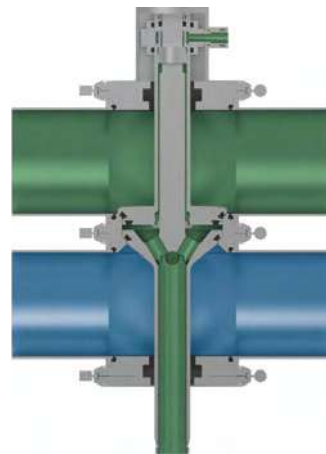

Spray cleaning in the double-seat valve

In this way, the leakage chamber can be cleaned independently from the pipe cleaning. In addition, this allows interim flushing to occur before or after a switching procedure of the valve.

Periphery

For spray cleaning via the external connection in the lantern, it is necessary to have feed valves in the periphery to channel the cleaning media into the cleaning connection of the double-seat valve at the intended time. For this purpose feed valves with a relatively small nominal width are used on the pipeline carrying the cleaning media. Each feed valve generally supplies several cleaning connections of double-seat valves. It should be noted that all connected double-seat valves must have an adequate supply of cleaning media during cleaning. As a rule of thumb, no more than six double-seat valves should be supplied from one feed valve.

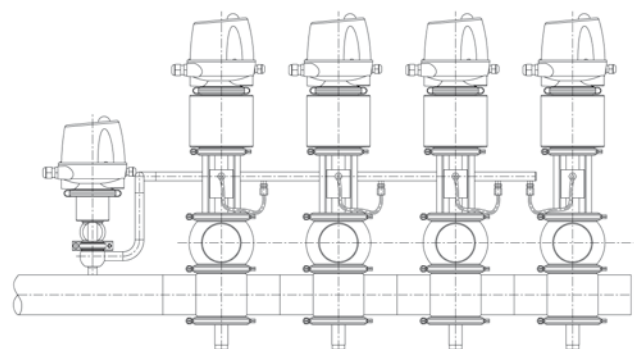

Application example of a feed valve



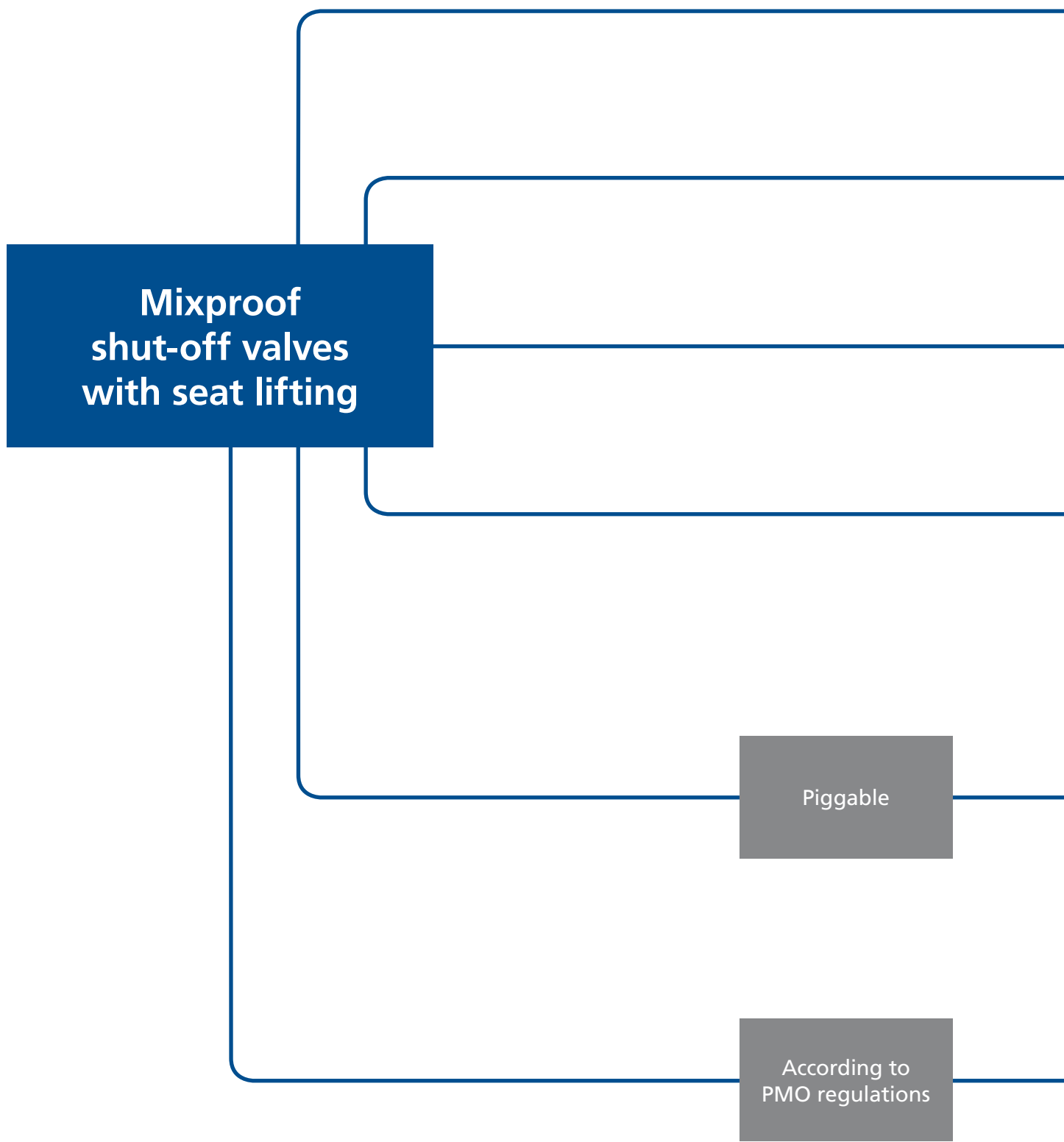

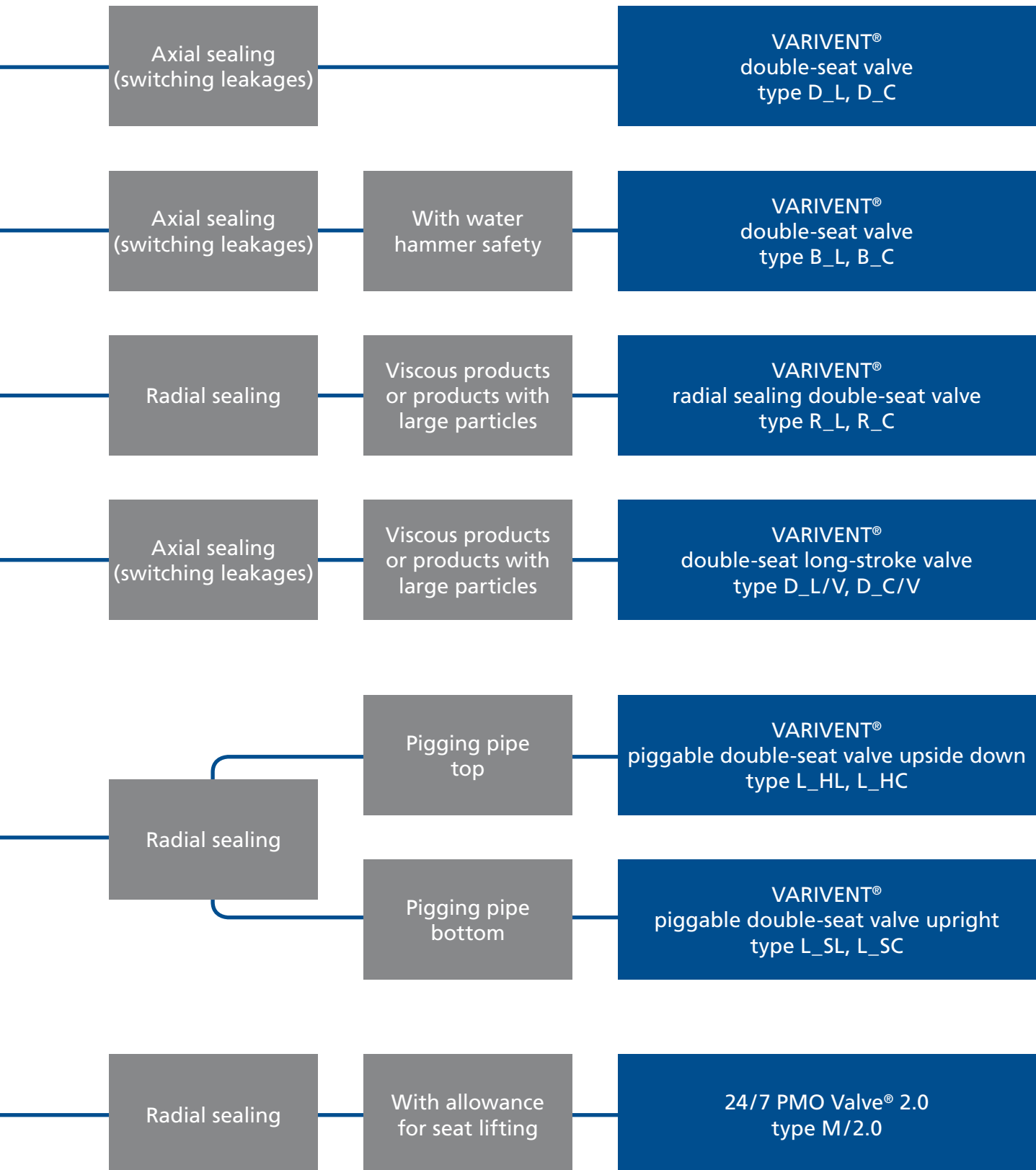



Technical data of the standard version		
Material in contact with the product	1.4404/AISI 316 L	
Material not in contact with the product	1.4301/AISI 304	
Seal material in contact with the product	EPDM, FKM, HNBR	
Ambient temperature	0 to 45 °C	
Air supply pressure	6 bar (87 psi)	
Product pressure	5 bar (73 psi)	
Surface in contact with the product	DN, OD	Ra ≤ 0.8 µm
	IPS	Ra ≤ 1.2 µm
External housing surface	Matte blasted	
Control and feedback system	Connection 0 (without control top)	
Actuator type	Pneumatic actuator air/spring	
Connection fittings	Welding end	
Identification	Adhesive ID tag	
Valve seat version	Clamped or welded seat ring	
Certificates		

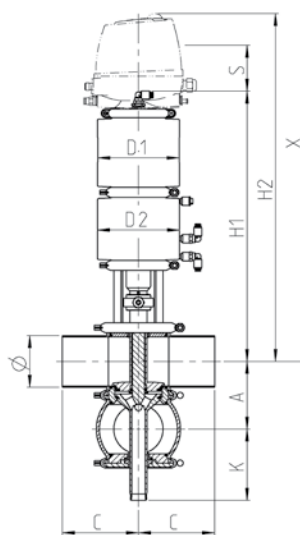







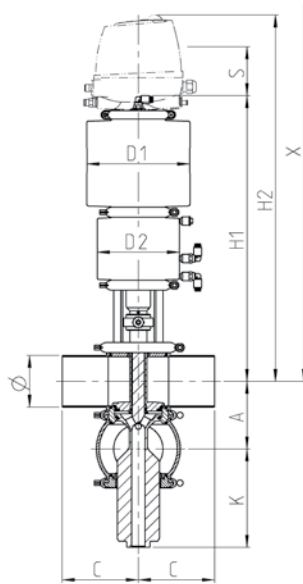



Nominal width	Pipe	Housing			Actuator		Dimensions			Valve	
	Ø [mm]	A [mm]	C [mm]	K [mm]	D1 [mm]	D2 [mm]	H1 [mm]	H2 [mm]	Extension X [mm]	Stroke S [mm]	Weight [kg]
DN 25	29.0 × 1.50	50.0	90	81	110	110	412	541	766	22	14
DN 40	41.0 × 1.50	62.0	90	93	110	110	426	555	780	22	16
DN 50	53.0 × 1.50	74.0	90	99	110	110	424	553	778	30	16
DN 65	70.0 × 2.00	96.0	125	125	135	135	435	564	914	30	23
DN 80	85.0 × 2.00	111.0	125	117	135	135	443	572	922	30	24
DN 100	104.0 × 2.00	130.0	125	137	170	170	482	611	961	30	34
DN 125	129.0 × 2.00	155.0	150	171	260	210	663	792	1282	60	72
DN 150	154.0 × 2.00	180.0	150	196	260	210	687	816	1306	60	85
OD 1"	25.4 × 1.65	46.0	90	83	110	110	414	543	768	18	14
OD 1 ½"	38.1 × 1.65	59.0	90	94	110	110	428	557	782	22	16
OD 2"	50.8 × 1.65	71.5	90	100	110	110	425	554	779	22	16
OD 2 ½"	63.5 × 1.65	90.0	125	128	135	135	438	567	917	30	23
OD 3"	76.2 × 1.65	103.0	125	121	135	135	447	576	926	30	23
OD 4"	101.6 × 2.11	127.5	125	138	170	170	483	612	962	30	34
OD 6"	152.4 × 2.77	177.0	150	197	260	210	689	818	1308	60	81
IPS 2"	60.3 × 2.00	81.0	114.3	95	110	110	421	550	775	30	17
IPS 3"	88.9 × 2.30	115.0	152.5	115	135	135	441	570	920	30	25
IPS 4"	114.3 × 2.30	140.0	152.5	132	170	170	477	606	956	30	35
IPS 6"	168.2 × 2.70	192.0	152.5	190	260	210	681	810	1300	60	82



Technical data of the standard version		
Material in contact with the product	1.4404/AISI 316 L	
Material not in contact with the product	1.4301/AISI 304	
Seal material in contact with the product	EPDM, FKM, HNBR	
Ambient temperature	0 to 45 °C	
Air supply pressure	6 bar (87 psi)	
Product pressure	5 bar (73 psi)	
Water hammer safety	Up to 25 bar	
Surface in contact with the product	DN, OD	Ra ≤ 0.8 µm
	IPS	Ra ≤ 1.2 µm
External housing surface	Matte blasted	
Control and feedback system	Connection 0 (without control top)	
Actuator type	Pneumatic actuator air/spring	
Connection fittings	Welding end	
Identification	Adhesive ID tag	
Valve seat version	Clamped or welded seat ring	
Certificates		



Nominal width	Pipe	Housing			Actuator		Dimensions			Valve	
	Ø [mm]	A [mm]	C [mm]	K [mm]	D1 [mm]	D2 [mm]	H1 [mm]	H2 [mm]	Extension X [mm]	Stroke S [mm]	Weight [kg]
DN 65	70.0 x 2.00	96.0	125	154	170	135	465	594.0	999	30	29
DN 80	85.0 x 2.00	111.0	125	162	170	135	473	601.5	1007	30	30
DN 100	104.0 x 2.00	130.0	125	162	210	170	482	611.0	1016	30	39
DN 125	129.0 x 2.00	155.0	150	265	210	210	663	791.5	1382	60	65
DN 150	154.0 x 2.00	180.0	150	275	260	210	687	816.0	1406	60	84
OD 2 1/2"	63.5 x 1.65	90.0	125	157	170	135	468	597.0	1002	30	29
OD 3"	76.2 x 1.65	103.0	125	166	170	135	477	605.5	1011	30	29
OD 4"	101.6 x 2.11	127.5	125	183	210	170	483	612.25	1017	30	39
OD 6"	152.4 x 2.77	177.0	150	277	260	210	689	817.5	1408	60	80
IPS 2"	60.3 x 2.00	81.0	114.3	131	110	110	428	556.5	817	30	18
IPS 3"	88.9 x 2.30	115.0	152.5	164	170	135	475	603.5	1009	30	30
IPS 4"	114.3 x 2.30	140.0	152.5	187	210	170	487	616.0	1021	30	41
IPS 6"	168.2 x 2.70	192.0	152.5	291	260	210	681	810.0	1400	60	81

Position	Description of the order code for the standard version					
1	Valve type					
	B VARIVENT® double-seat valve, with balancer					
2	Housing combinations					
						
3	Supplement to the valve type					
	L With lifting actuator and spray cleaning					
	C With lifting actuator without spray cleaning					
4/5	Nominal width (upper housing / lower housing)					
	DN 65	OD 2 ½"	IPS 2"			
	DN 80	OD 3"	IPS 3"			
	DN 100	OD 4"	IPS 4"			
	DN 125					
	DN 150	OD 6"	IPS 6"			
6	Actuator type					
	S Air/Spring					
7	Non-actuated position					
	Z Spring-to-close (NC)					
8	Standard configuration with 6 bar air supply pressure for 5 bar product pressure (higher pressures on request)					
	Actuator (spring-to-close)	/ Lifting actuator	For nominal widths			
	BB	/BLB	IPS 2"			
	DD	/CLB	DN 65, DN 80, OD 2 ½", OD 3", IPS 3"			
	EF	/DLB	DN 100, OD 4", IPS 4"			
	EF6	/EL6	DN 125			
	SG6	/EL6	DN 150, OD 6", IPS 6"			
9	Valve seat version (upper housing / lower housing)		Housing combination			
	L0	Loose seat ring/Clamp connection	A	B	C	E
			√	√	√	√
	V1	Welded seat ring/ Port orientation 90°				
	V2	Welded seat ring/ Port orientation 180°				
	V3	Welded seat ring/ Port orientation 270°				
10	Seal material in contact with the product					
	1 EPDM (FDA)					
	2 FKM (FDA)					
	3 HNBR (FDA); (up to DN 100, OD 4", IPS OD 4")					
11	Surface quality of the housing					
	1 Inside Ra ≤ 1.2 µm, outside matte blasted (IPS)					
	2 Inside Ra ≤ 0.8 µm, outside matte blasted (DN, OD)					
12	Connection fittings					
	N Welding end					
13	Accessories					
	/52 Adhesive ID tag					
+						
14-19	Air connection / Control and feedback system					
	00000M Metric for air hose Ø 6/4 mm					
	00000Z Inch for air hose Ø OD ¼" (6.35/4.35 mm)					
	XXXXX Order code for different control and feedback systems see section 9					

The code is composed as following, depending on the chosen configuration:

Position	1	2	3	4/5	6	7	8	9	10	11	12	13	14 to 19				
Code	B			/	S	Z	/				N	/52					







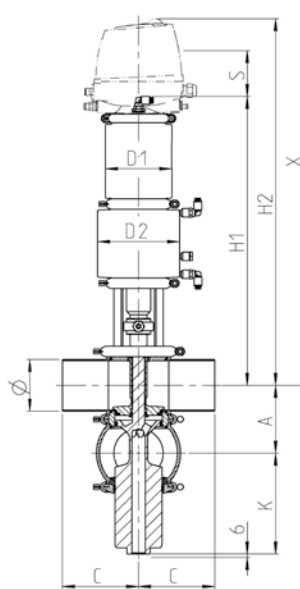

For order codes differing from the standard version, please refer to section 7 (options).



Technical data of the standard version	
Material in contact with the product	1.4404/AISI 316 L
Material not in contact with the product	1.4301/AISI 304
Seal material in contact with the product	EPDM, FKM, HNBR
Ambient temperature	0 to 45 °C
Air supply pressure	6 bar (87 psi)
Product pressure	5 bar (73 psi)
Water hammer safety	30 bar (up to DN 50, OD 2", IPS 2") 50 bar (from DN 65, OD 2 1/2", IPS 3")
Surface in contact with the product	DN, OD Ra ≤ 0.8 µm
	IPS Ra ≤ 1.2 µm
External housing surface	Matte blasted
Control and feedback system	Connection 0 (without control top)
Actuator type	Pneumatic actuator air/spring
Connection fittings	Welding end
Identification	Adhesive ID tag
Valve seat version	Clamped or welded seat ring
Certificates	



Nominal width	Pipe	Housing			Actuator		Dimensions			Valve	
	Ø [mm]	A [mm]	C [mm]	K [mm]	D1 [mm]	D2 [mm]	H1 [mm]	H2 [mm]	Extension X [mm]	Stroke S [mm]	Weight [kg]
DN 25	29.0 × 1.50	50.0	90	91.0	110	110	412.00	541.00	801	25	14
DN 40	41.0 × 1.50	62.0	90	129.5	110	110	426.00	555.00	815	28	17
DN 50	53.0 × 1.50	74.0	90	135.5	110	110	424.00	553.00	813	31	17
DN 65	70.0 × 2.00	96.0	125	164.5	110	135	435.00	564.00	969	35	25
DN 80	85.0 × 2.00	111.0	125	172.0	110	135	472.50	601.50	1007	45	26
DN 100	104.0 × 2.00	130.0	125	192.5	110	170	482.00	611.00	1016	45	32
DN 125	129.0 × 2.00	155.0	150	258.0	170	210	615.50	744.50	1335	65	59
DN 150	154.0 × 2.00	180.0	150	272.5	170	210	640.00	769.00	1359	65	70
OD 1"	25.4 × 1.65	46.0	90	93.0	110	110	414.00	543.00	803	22	14
OD 1 1/2"	38.1 × 1.65	59.0	90	128.0	110	110	427.50	556.50	817	21	17
OD 2"	50.8 × 1.65	71.5	90	137.0	110	110	425.25	554.25	814	31	17
OD 2 1/2"	63.5 × 1.65	90.0	125	167.5	110	135	438.00	567.00	972	35	25
OD 3"	76.2 × 1.65	103.0	125	176.0	110	135	476.50	605.50	1011	45	26
OD 4"	101.6 × 2.11	127.5	125	194.0	110	170	483.25	612.25	1017	45	32
OD 6"	152.4 × 2.77	177.0	150	274.0	170	210	641.50	770.50	1361	60	66
IPS 2"	60.3 × 2.00	81.0	114.3	139.0	110	110	427.50	556.50	817	31	18
IPS 3"	88.9 × 2.30	115.0	152.5	174.0	110	135	474.50	603.50	1009	35	27
IPS 4"	114.3 × 2.30	140.0	152.5	197.5	110	170	487.00	616.00	1021	45	34
IPS 6"	168.2 × 2.70	192.0	152.5	278.5	170	210	634.00	763.00	1353	65	67

Position	Description of the order code for the standard version			
1	Valve type			
	R	VARIVENT® double-seat valve, radial sealing		
2	Housing combinations			
	A	B	C	E
				
3	Supplement to the valve type			
	L	With lifting actuator and spray cleaning		
	C	With lifting actuator without spray cleaning		
4/5	Nominal width (upper housing / lower housing)			
	DN 25	OD 1"		
	DN 40	OD 1 ½"		
	DN 50	OD 2"	IPS 2"	
	DN 65	OD 2 ½"		
	DN 80	OD 3"	IPS 3"	
	DN 100	OD 4"	IPS 4"	
	DN 125			
	DN 150	OD 6"	IPS 6"	
6	Actuator type			
	S	Air/Spring		
7	Non-actuated position			
	Z	Spring-to-close (NC)		
8	Standard configuration with 6 bar air supply pressure for 5 bar product pressure (higher pressures on request)			
	Actuator (spring-to-close)	/Lifting actuator	For nominal widths	
	BD	/BLR	DN 25, DN 40, DN 50, OD 1", OD 1 ½", OD 2", IPS 2"	
	BD	/CLR	DN 65, OD 2 ½"	
	BD	/CLR5	DN 80, OD 3", IPS 3"	
	BD5	/DLR5	DN 100, OD 4", IPS 4"	
	DF6	/ELR6	DN 125, DN 150, OD 6", IPS 6"	
9	Valve seat version (upper housing / lower housing)		Housing combination	
	L0	Loose seat ring/Clamp connection	A	B
			✓	✓
	V1	Welded seat ring/ Port orientation 90°		
	V2	Welded seat ring/ Port orientation 180°		
	V3	Welded seat ring/ Port orientation 270°		
10	Seal material in contact with the product			
	1	EPDM (FDA)		
	2	FKM (FDA)		
	3	HNBR (FDA); (up to DN 100, OD 4", IPS OD 4")		
11	Surface quality of the housing			
	1	Inside Ra ≤ 1.2 µm, outside matte blasted (IPS)		
	2	Inside Ra ≤ 0.8 µm, outside matte blasted (DN, OD)		
12	Connection fittings			
	N	Welding end		
13	Accessories			
	/52	Adhesive ID tag (up to DN 50, OD 2", IPS 2")		
	/52/05	Adhesive ID tag (from DN 65, OD 2 ½", IPS 3")		
+				
14-19	Air connection/Control and feedback system			
	00000M	Metric for air hose Ø 6/4 mm		
	00000Z	Inch for air hose Ø OD ¼" (6.35/4.35 mm)		
	XXXXX	Order code for different control and feedback systems see section 9		

The code is composed as following, depending on the chosen configuration:

Position	1	2	3	4/5	6	7	8	9	10	11	12	13	14 to 19					
Code	R			/	S	Z					N							

For order codes differing from the standard version, please refer to section 7 (options).







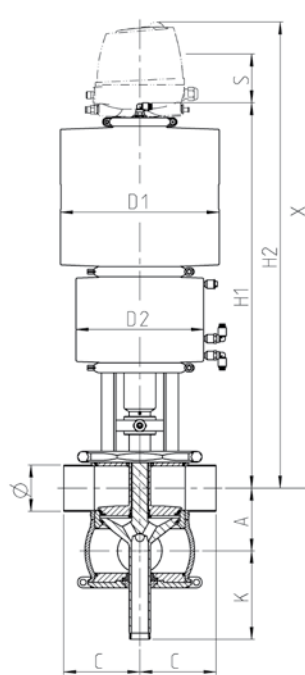

Technical data of the standard version	
Material in contact with the product	1.4404/AISI 316 L
Material not in contact with the product	1.4301/AISI 304
Seal material in contact with the product	EPDM, FKM, HNBR
Ambient temperature	0 to 45 °C
Air supply pressure	6 bar (87 psi)
Product pressure	5 bar (73 psi)
Surface in contact with the product	Ra ≤ 0.8 µm
External housing surface	Matte blasted
Control and feedback system	Connection 0 (without control top)
Actuator type	Pneumatic actuator air/spring
Connection fittings	Welding end
Identification	Adhesive ID tag
Valve seat version	Clamped or welded seat ring
Certificates	



Nominal width	Pipe	Housing			Actuator		Dimensions			Valve	
	Ø [mm]	A [mm]	C [mm]	K [mm]	D1 [mm]	D2 [mm]	H1 [mm]	H2 [mm]	Extension X [mm]	Stroke [mm]	Weight [kg]
OD 3"	76.2 × 1.65	103.0	125	145	260	210	637	766	1116	60	67
OD 4"	101.6 × 2.11	127.5	150	157	260	210	649	778	1128	60	75

Position	Description of the order code for the standard version	
1	Valve type D VARIVENT® double-seat valve	
2	Housing combinations 	
3	Supplement to the valve type L/V Long stroke with lifting actuator and spray cleaning C/V Long stroke with lifting actuator without spray cleaning	
4/5	Nominal width (upper housing / lower housing) OD 3" OD 4"	
6	Actuator type S Air/Spring	
7	Non-actuated position Z Spring-to-close (NC)	
8	Standard configuration with 6 bar air supply pressure for 5 bar product pressure (higher pressures on request)	
	Actuator (spring-to-close)	Lifting actuator
	SH6	/ELB
	SK6	/ELB
		For nominal widths
		OD 3"
		OD 4"
9	Valve seat version (upper housing / lower housing)	Housing combination
	L0 Loose seat ring/ Clamp connection	A B C E
	V1 Welded seat ring/ Port orientation 90°	
	V2 Welded seat ring/ Port orientation 180°	
	V3 Welded seat ring/ Port orientation 270°	
10	Seal material in contact with the product	
	1 EPDM (FDA)	
	2 FKM (FDA)	
	3 HNBR (FDA)	
11	Surface quality of the housing	
	2 Inside Ra ≤ 0.8 µm, outside matte blasted	
12	Connection fittings	
	N Welding end	
13	Accessories	
	/52 Adhesive ID tag	
+		
14-19	Air connection / Control and feedback system	
	00000M Metric for air hose Ø 6/4 mm	
	00000Z Inch for air hose Ø OD ¼" (6.35/4.35 mm)	
	XXXXX Order code for different control and feedback systems see section 9	



The code is composed as following, depending on the chosen configuration:

Position	1	2	3	4/5	6	7	8	9	10	11	12	13	14 to 19				
Code	D			/	S	Z	/			2	N	/52					



For order codes differing from the standard version, please refer to section 7 (options).

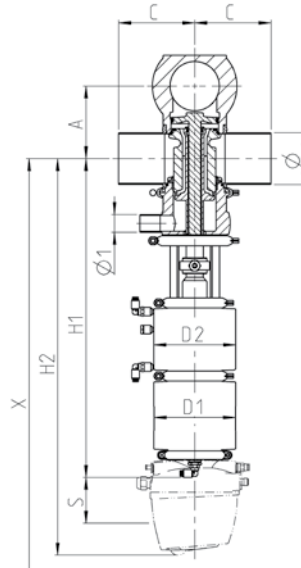

Technical data of the standard version	
Material in contact with the product	1.4404/AISI 316 L
Material not in contact with the product	1.4301/AISI 304
Seal material in contact with the product	EPDM, FKM, HNBR
Ambient temperature	0 to 45 °C
Air supply pressure	6 bar (87 psi)
Product pressure	7 bar (101 psi)
Surface in contact with the product	Ra ≤ 0.8 µm
External housing surface	Matte blasted
Control and feedback system	Connection 0 (without control top)
Actuator type	Pneumatic actuator air/spring
Connection fittings	Welding end
Identification	Adhesive ID tag
Valve seat version	Welded seat ring
Certificates	

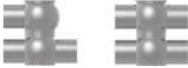

Nominal width	Pipe	Pipe leakage	Housing		Actuator		Dimensions			Valve	
	Ø [mm]	Ø1 [mm]	A [mm]	C [mm]	D1 [mm]	D2 [mm]	H1 [mm]	H2 [mm]	Extension X [mm]	Stroke S [mm]	Weight [kg]
DN 40	41.0 × 1.50	23 × 1.5	74.0	90	110	170	544	544	649	25	16
DN 50	53.0 × 1.50	23 × 1.5	86.0	90	110	170	550	550	655	33	16
DN 65	70.0 × 2.00	29 × 1.5	104.0	125	135	170	590	590	765	35	29
DN 80	85.0 × 2.00	29 × 1.5	119.0	125	135	170	597	597	772	35	29
DN 100	104.0 × 2.00	29 × 1.5	138.0	125	170	170	597	597	772	35	43
OD 1 ½"	38.1 × 1.65	23 × 1.5	71.0	90	110	170	545	545	650	25	16
OD 2"	50.8 × 1.65	23 × 1.5	83.5	90	110	170	551	551	656	33	16
OD 2 ½"	63.5 × 1.65	29 × 1.5	98.0	125	135	170	594	594	769	35	29
OD 3"	76.2 × 1.65	29 × 1.5	111.0	125	135	170	600	600	775	35	28
OD 4"	101.6 × 2.11	29 × 1.5	135.5	125	170	170	598	598	773	35	43

Position	Description of the order code for the standard version		
1	Valve type		
	L	VARIVENT® double-seat valve, piggable	
2	Housing combinations		
	C	E	
3	Supplement to the valve type		
	HL	Suspended with lifting actuator and spray cleaning	
	HC	Suspended with lifting actuator without spray cleaning	
4/5	Nominal width (upper housing / lower housing)		
	DN 40	OD 1 ½"	
	DN 50	OD 2"	
	DN 65	OD 2 ½"	
	DN 80	OD 3"	
	DN 100	OD 4"	
6	Actuator type		
	S	Air/Spring	
7	Non-actuated position		
	Z	Spring-to-close (NC)	
8	Standard configuration with 6 bar air supply pressure for 7 bar product pressure (higher pressures on request)		
	Actuator (spring-to-close)	/Lifting actuator	For nominal widths
	BD	/BLRN 40	DN 40, OD 1 ½"
	BD	/BLRN 50	DN 50, OD 2"
	CF	/CLT	DN 65, DN 80, OD 2 ½", OD 3"
	DG	/DLRN	DN 100, OD 4"
9	Valve seat version (upper housing /lower housing)		Housing combination
	V1	Welded seat ring/ Port orientation 90°	C E 
10	Seal material in contact with the product		
	1	EPDM (FDA)	
	2	FKM (FDA)	
	3	HNBR (FDA)	
11	Surface quality of the housing		
	2	Inside Ra ≤ 0.8 µm, outside matte blasted	
12	Connection fittings		
	N	Welding end	
13	Accessories		
	/52	Adhesive ID tag	
+			
14-19	Air connection/ Control and feedback system		
	00000M	Metric for air hose Ø 6/4 mm	
	00000Z	Inch for air hose Ø OD ¼" (6.35/4.35 mm)	
	XXXXX	Order code for different control and feedback systems see section 9	

The code is composed as following, depending on the chosen configuration:

Position	1	2	3	4/5	6	7	8	9	10	11	12	13	14 to 19			
Code	L			/	S	Z	/	V1		2	N	/52				



For order codes differing from the standard version, please refer to section 7 (options).

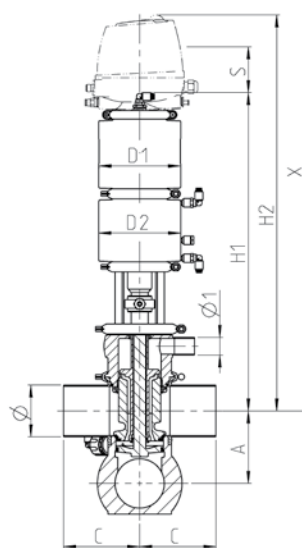

Technical data of the standard version	
Material in contact with the product	1.4404/AISI 316 L
Material not in contact with the product	1.4301/AISI 304
Seal material in contact with the product	EPDM, FKM, HNBR
Ambient temperature	0 to 45 °C
Air supply pressure	6 bar (87 psi)
Product pressure	7 bar (101 psi)
Surface in contact with the product	Ra ≤ 0.8 µm
External housing surface	Matte blasted
Control and feedback system	Connection 0 (without control top)
Actuator type	Pneumatic actuator air/spring
Connection fittings	Welding end
Identification	Adhesive ID tag
Valve seat version	Welded seat ring
Certificates	



Nominal width	Pipe	Pipe leakage	Housing		Actuator		Dimensions			Valve	
	Ø [mm]	Ø1 [mm]	A [mm]	C [mm]	D1 [mm]	D2 [mm]	H1 [mm]	H2 [mm]	Extension X [mm]	Stroke S [mm]	Weight [kg]
DN 40	41.0 × 1.50	23 × 1.5	74.0	90	110	170	415	544	649	25	16
DN 50	53.0 × 1.50	23 × 1.5	86.0	90	110	170	421	550	655	33	17
DN 65	70.0 × 2.00	29 × 1.5	104.0	125	135	170	461	590	765	35	29
DN 80	85.0 × 2.00	29 × 1.5	119.0	125	135	170	468	597	772	35	30
DN 100	104.0 × 2.00	29 × 1.5	138.0	125	170	170	468	597	772	35	38
OD 1 ½"	38.1 × 1.65	23 × 1.5	71.0	90	110	170	416	545	650	25	16
OD 2"	50.8 × 1.65	23 × 1.5	83.5	90	110	170	422	551	656	33	17
OD 2 ½"	63.5 × 1.65	29 × 1.5	98.0	125	135	170	465	594	769	35	29
OD 3"	76.2 × 1.65	29 × 1.5	111.0	125	135	170	471	600	775	35	28
OD 4"	101.6 × 2.11	29 × 1.5	135.5	125	170	170	469	598	773	35	38

Position	Description of the order code for the standard version		
1	Valve type L VARIVENT® double-seat valve, piggable		
2	Housing combinations 		
3	Supplement to the valve type SL Upright with lifting actuator and spray cleaning SC Upright with lifting actuator without spray cleaning		
4/5	Nominal width (upper housing / lower housing) DN 40 OD 1 ½" DN 50 OD 2" DN 65 OD 2 ½" DN 80 OD 3" DN 100 OD 4"		
6	Actuator type S Air/Spring		
7	Non-actuated position Z Spring-to-close (NC)		
8	Standard configuration with 6 bar air supply pressure for 7 bar product pressure (higher pressures on request)		
	Actuator (spring-to-close)	/Lifting actuator	For nominal widths
	BD	/BLRN 40	DN 40, OD 1 ½"
	BD	/BLRN 50	DN 50, OD 2"
	CF	/CLT	DN 65, DN 80, OD 2 ½", OD 3"
	DG	/DLRN	DN 100, OD 4"
9	Valve seat version (upper housing /lower housing)	Housing combination	
	V1 Welded seat ring/ Port orientation 90°		
10	Seal material in contact with the product 1 EPDM (FDA) 2 FKM (FDA) 3 HNBR (FDA)		
11	Surface quality of the housing 2 Inside Ra ≤ 0.8 µm, outside matte blasted		
12	Connection fittings N Welding end		
13	Accessories /52 Adhesive ID tag		
+			
14-19	Air connection/ Control and feedback system 00000M Metric for air hose Ø 6/4 mm 00000Z Inch for air hose Ø OD ¼" (6.35/4.35 mm) XXXXX Order code for different control and feedback systems see section 9		



The code is composed as following, depending on the chosen configuration:

Position	1	2	3	4/5	6	7	8	9	10	11	12	13	14 to 19					
Code	L			/	S	Z	/	V1		2	N	/52						

For order codes differing from the standard version, please refer to section 7 (options).



VARIVENT®

The 24/7 PMO Valve® 2.0 is standardized and tailor-made for use in PMO-regulated systems.

Sizes
Double-seat valves
OD 1 ½" – OD 6"

Application examples

Dairy plants that are subject to the PMO use this valve in all non-aseptic process areas, e.g. milk reception, raw milk storage and distribution systems, pasteurizer in- and outlets and filling lines.

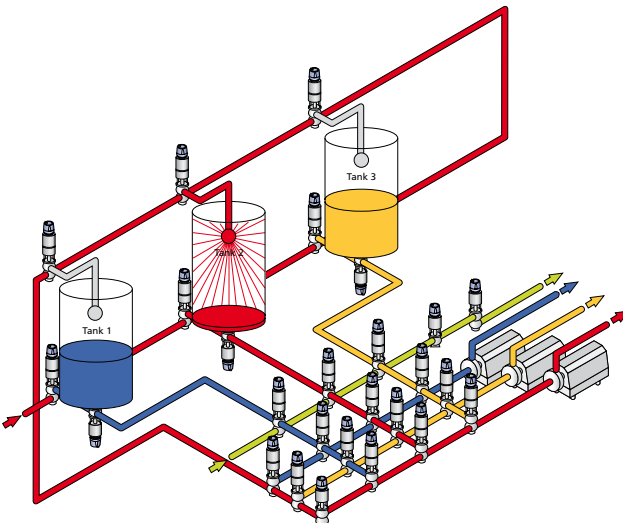

This method prevents any mixture between a product pipe and a pipe carrying cleaning media.

24/7 PMO VALVE®

24/7 PMO Valve® is a registered trade mark of GEA Tuchenhagen GmbH. It describes double-seat valves that have been authorised for use in PMO-regulated systems, where seat lifting occurs to clean the leakage chamber while the other pipeline is carrying product. This grants system operators the possibility of cleaning all valve parts in contact with the product simultaneously with the production process. In this way, the valves permit uninterrupted production on a 24/7 basis.

Mixproof separation

The VARIVENT® 24/7 PMO Valve® 2.0 is almost exclusively used in dairy applications subject to the regulations of the Pasteurized Milk Ordinance (PMO). Primarily, this concerns dairies in the United States. These valves are used for mixproof shut-off of incompatible products at pipe junctions.

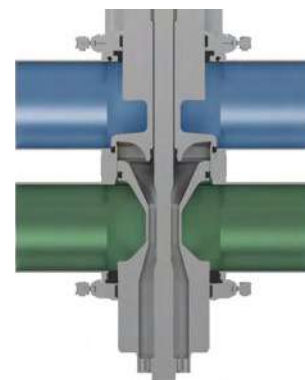

Mixproof separation by two seals

When the valve is closed (non-actuated position), there are always two seals between the separated pipelines. If one seal is defective, the resulting leakage will be directed through the leakage outlet into the periphery, without mixing with the product in the second pipeline.

Cleaning the leakage chamber

Lifting actuator

The valves are always equipped with a lifting actuator which permits individual lifting of an individual valve disc during the particular pipe cleaning. The 24/7 PMO Valve® 2.0 satisfies the strict requirements of the PMO (Pasteurized Milk Ordinance) and is certified acc. to 3-A Standard 85-02 for performing the lift function while milk or milk products are being transported in the other pipeline.

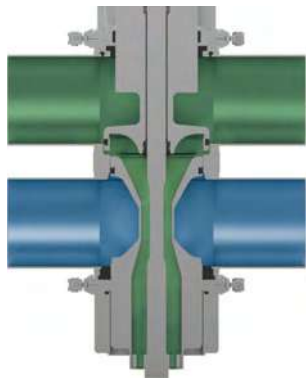

If there is cleaning media in the upper pipeline, the upper valve disc can be lifted up to allow the surface of the seal and the leakage chamber to be cleaned.

In this case, the cleaning media passes the seal of the lifted valve disc, cleans the leakage chamber and then flows out through the leakage outlet into the periphery. Therefore, it is possible to clean all surfaces that come into contact with the product, including the seal surfaces of the valve disc seals.

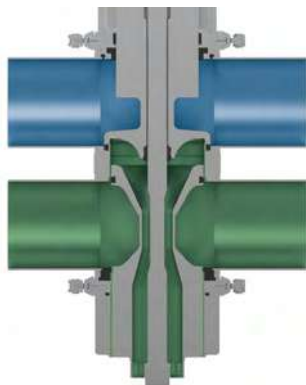

If there is cleaning media in the lower pipeline, the lower valve disc can be lowered downward to allow the surface of the seal and the leakage chamber to be cleaned.

Cleaning of the balancer surface

Article “Item 12p. Cleaning and sanitizing of containers and equipment” of the PMO stipulates that each surface that comes into contact with the product must be cleaned at least once a day. For this reason, the 24/7 PMO Valve® 2.0 is equipped with a balancer cleaning device as standard. During lifting of the lower valve disc, a gap is automatically left open between the lower balancer seal and the valve disc. Cleaning media can thus get into the balancer cleaning device and clean the surface of the balancer. In this way, the valve meets the requirements of Item 12p. of the PMO without requiring further measures to be taken. Optionally, however, the valves can also be delivered without a balancer cleaning device if the surface will be cleaned in another way, e.g. by a full stroke during cleaning.

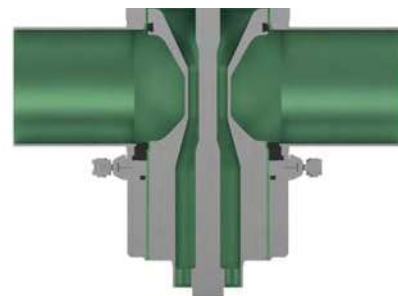

Cleaning of the balancer surface by the balancer cleaning device

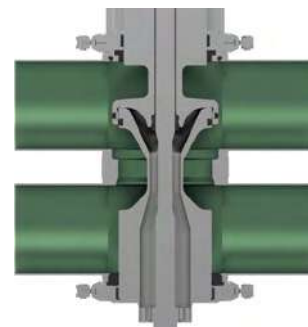

Cleaning of the balancer surface by a full stroke







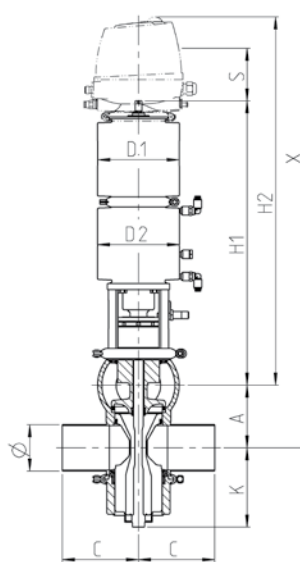

Technical data of the standard version	
Material in contact with the product	1.4404/AISI 316 L
Material not in contact with the product	1.4301/AISI 304
Seal material in contact with the product	EPDM, FKM, HNBR
Ambient temperature	0 to 45 °C
Air supply pressure	6 bar (87 psi)
Product pressure	10 bar (145 psi)
Surface in contact with the product	Ra ≤ 0.8 µm
External housing surface	Matte blasted
Control and feedback system	Selectable; the feedback of all valve positions is required acc. to PMO
Actuator type	Pneumatic actuator air/spring
Connection fittings	Welding end
Identification	Adhesive ID tag
Valve seat version	Welded seat ring
Certificates	



Nominal width	Pipe	Housing			Actuator		Dimensions		Valve	
	Ø [mm]	A [mm]	C [mm]	K [mm]	D1 [mm]	D2 [mm]	H2 [mm]	Extension X [mm]	Stroke S [mm]	Weight [kg]
OD 1 ½"	38.1 × 1.65	59.0	90	94.5	110	110	564.0	789.0	27.5	17
OD 2"	50.8 × 1.65	71.5	90	108.5	110	110	570.0	795.0	35.0	20
OD 2 ½"	63.5 × 1.65	90.0	125	124.0	135	135	598.0	948.0	45.0	27
OD 3"	76.2 × 1.65	103.0	125	130.5	135	135	605.0	955.0	45.0	27
OD 4"	101.6 × 2.11	127.5	125	142.5	135	135	617.0	967.0	45.0	39
OD 6"	152.4 × 2.77	177.0	150	190.0	170	210	761.5	1251.5	65.0	80

Position	Description of the order code for the standard version		
1	Valve type M 24/7 PMO Valve® 2.0		
2	Housing combinations 		
3	Supplement to the valve type O With lifting actuator without spray cleaning		
4/5	Nominal width (upper housing / lower housing) OD 1 1/2" OD 2" OD 2 1/2" OD 3" OD 4" OD 6"		
6	Actuator type S Air/Spring		
7	Non-actuated position Z Spring-to-close (NC)		
8	Standard configuration with 6 bar air supply pressure for 10 bar product pressure (higher pressures on request)		
	Actuator (spring-to-close)	/Lifting actuator	For nominal widths
	BD	/BLM	OD 1 1/2", OD 2"
	CF5	/CLM	OD 2 1/2", OD 3", OD 4"
	DG6	/ELM	OD 6"
9	Valve seat version (upper housing / lower housing)	Housing combination	
	V1 Welded seat ring/ Port orientation 90°		
	V2 Welded seat ring/ Port orientation 180°		
	V3 Welded seat ring/ Port orientation 270°		
10	Seal material in contact with the product		
	1 EPDM (FDA)		
	2 FKM (FDA)		
	3 HNBR (FDA); (up to OD 4")		
11	Surface quality of the housing		
	5 Inside Ra ≤ 0.8 µm, valve completely ground		
12	Connection fittings		
	N Welding end		
13	Accessories		
	/3A/52 /B/2.0	Valve after 3-A, adhesive ID tag, with outer balancer flushing (balancer cleaning device)	
	/3A/52 /2.0	Valve after 3-A, adhesive ID tag, without outer balancer flushing (balancer cleaning device)	
+			
14-19	Air connection/Control and feedback system XXXXXX Order code for control and feedback systems see section 9		

The code is composed as following, depending on the chosen configuration:

Position	1	2	3	4/5	6	7	8	9	10	11	12	13	14 to 19
Code	M		O	/	S	Z				5	N		

For order codes differing from the standard version, please refer to section 7 (options).



VARIVENT®

The VARIVENT® modular system has many options available. Please refer to the options section (section 7) for information about these.

Sizes
Double-seat divert valves
DN 25–DN 150
OD 1" –OD 6"
IPS 2" –IPS 6"

Mixproof separation

VARIVENT® mixproof divert valves are used for distributing liquid in pipelines, i.e. for distributing a liquid from one pipeline into two others, in which case one of the two pipelines must be shut off from the outlet line with a mixproof function.

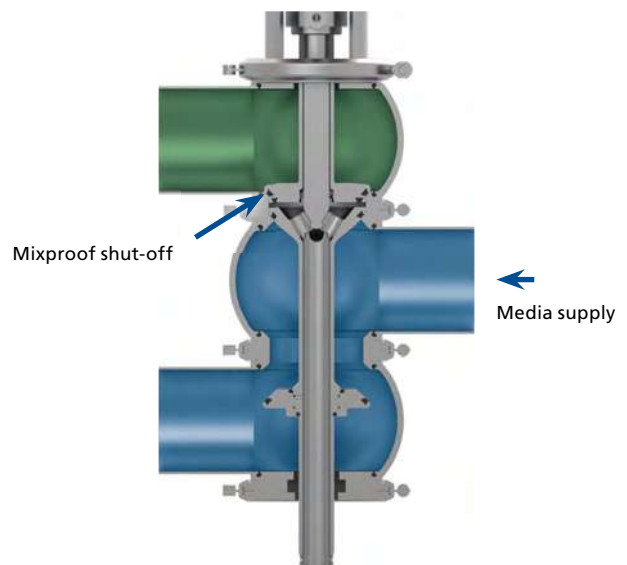

Mixproof separation between the upper and middle housing by two seals

Application examples

The typical application for this mixproof valve with changeover function is the divert function after a pasteurizer. For this application, the VARIVENT® mixproof divert valve type Y has been approved by the German Federal Dairy Research Center in Kiel for use after a pasteurizer.

Special features
Certified hygienic configuration
Metallic stop
Flexibility because of the modular principle
Proven seal geometry
Mixproof separation
Optional separate lifting actuator for lifting the two valve discs
Optional spray cleaning connection for cleaning the leakage chamber

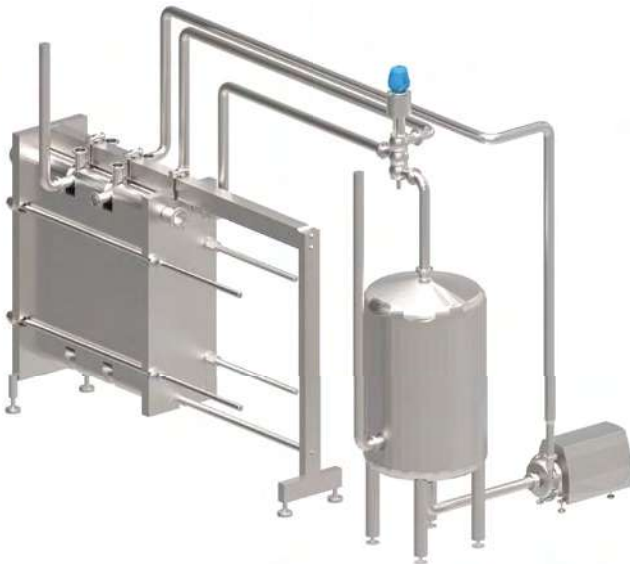

Mixproof divert function after a pasteurizer

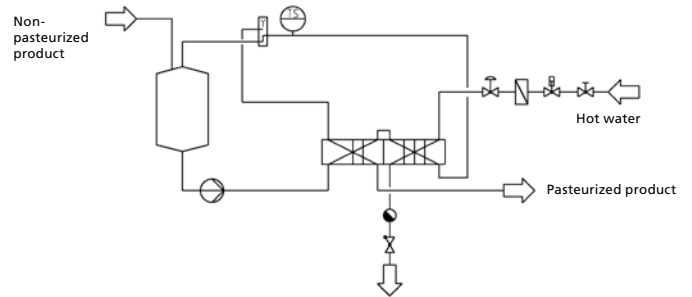

P&I Diagram



Function of the valve

When the valve is closed (non-actuated position), there are always two seals between the middle and upper pipeline. If one seal is defective at this point, the resulting leakage can be deliberately channelled through the leakage outlet into the periphery, without mixing with the product in the second pipeline. The shut-off between the middle and lower housing is performed with only one seal, and is not suitable for separating two incompatible media.

This method enables that there will not be any mixture between the products in the pipelines.

Switching leakage

In axial sealing double-seat valves, with every switching procedure there is a short time during which the lower valve disc is neither in contact with the middle seal of the upper valve disc, nor has it reached the axial seat surface of the seat ring. During this brief moment liquid can percolate through the resulting gap into the leakage chamber and flow out into the atmosphere. This is referred to as the switching leakage.

Cleaning the leakage chamber

Lifting actuator (type Y_C, Y_L)

The valves are equipped with a lifting actuator which permits individual lifting of an individual valve disc during the particular pipe cleaning.

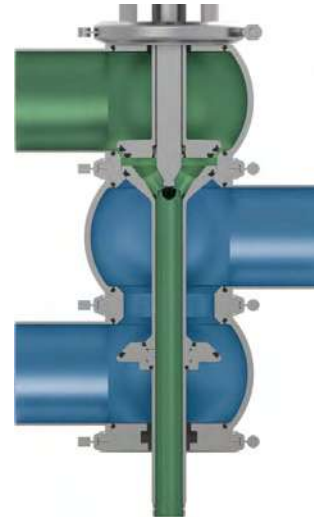

If there is cleaning media in the upper pipeline, the upper valve disc can be lifted up to allow the cleaning of the surface of the seal and the leakage chamber to be cleaned.

In this case, the cleaning media passes the seal of the lifted valve disc, cleans the leakage chamber and then flows out through the leakage outlet into the periphery. In this way, it is possible to clean all surfaces that come into contact with the product, including the seal surfaces of the valve disc seals.

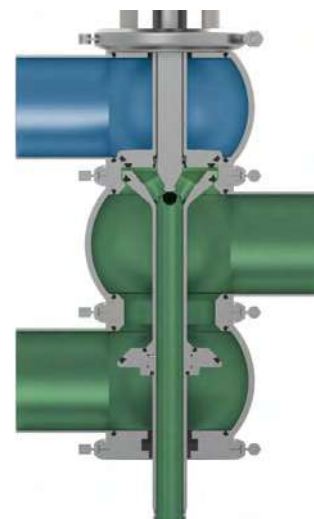

If there is cleaning media in the lower pipeline, valve type Y permits lifting of the lower valve disc upwards.

Spray cleaning (type Y, Y_L)

The valves have a cleaning connection to be connected at the level of the lantern either on its own (type Y) or additionally next to the lifting actuator (type Y_L). This connection allows the leakage chamber to be supplied with cleaning media from an external source in order to clean this chamber (in addition to the lifting actuator) by means of an integrated spray nozzle. After that, the cleaning media flows through the leakage outlet without pressure into the periphery. Cleaning takes place with the valve closed, which means the seal surfaces in contact are not touched during cleaning.

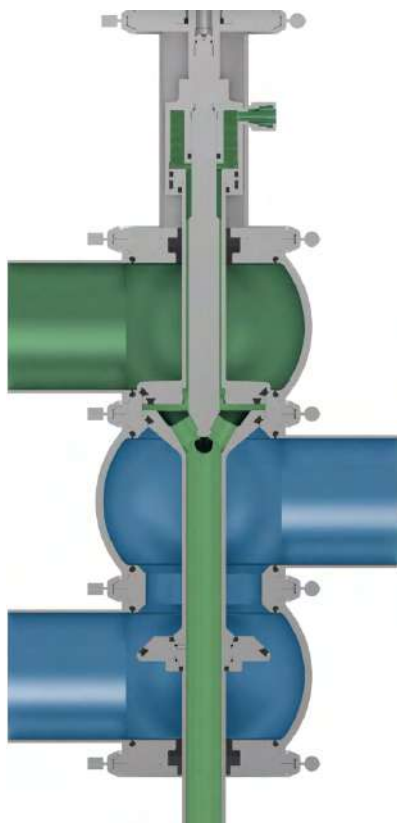

Spray cleaning in the double-seat valve

If valves are equipped with both a lifting actuator and the possibility of external spray cleaning, then spray cleaning is only used for interim flushing during the individual switching procedures, whereas thorough cleaning is performed by lifting.

Periphery

For spray cleaning via the external connection in the lantern, it is necessary to have feed valves in the periphery which channel the cleaning media to the cleaning connection. For this purpose feed valves with a relatively small nominal width are used on the pipeline carrying the cleaning media. Each feed valve generally supplies several cleaning connections of double-seat valves. It should be noted that all connected double-seat valves must have an adequate supply of cleaning media during cleaning. As a rule of thumb, no more than six double-seat valves should be supplied from one feed valve.

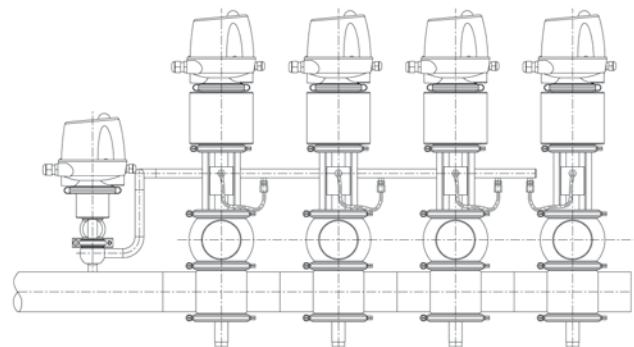

Application example of a feed valve

**Mixproof
divert valves**

VARIVENT®
double-seat valve
type Y

With seat lifting

VARIVENT®
double-seat valve
type Y_L, Y_C



Technical data of the standard version		
Material in contact with the product	1.4404/AISI 316 L	
Material not in contact with the product	1.4301/AISI 304	
Seal material in contact with the product	EPDM, FKM, HNBR	
Ambient temperature	0 to 45 °C	
Air supply pressure	6 bar (87 psi)	
Product pressure	5 bar (73 psi)	
Surface in contact with the product	DN, OD	Ra ≤ 0.8 µm
	IPS	Ra ≤ 1.2 µm
External housing surface	Matte blasted	
Control and feedback system	Connection 0 (without control top)	
Actuator type	Pneumatic actuator air/spring	
Connection fittings	Welding end	
Identification	Adhesive ID tag	
Valve seat version	Clamped seat ring	
Certificates		

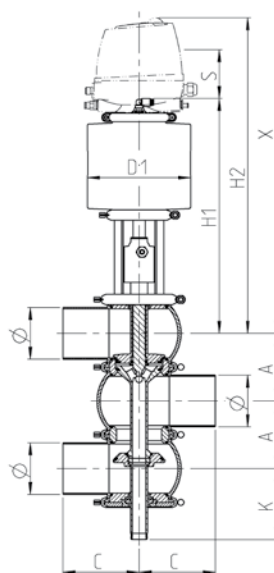

Nominal width	Pipe		Housing			Actuator	Dimensions			Valve	
	Ø [mm]	A [mm]	C [mm]	K [mm]	D1 [mm]	H1 [mm]	H2 [mm]	Extension X [mm]	Stroke S [mm]	Weight [kg]	
DN 25	29.0 × 1.50	50.0	90	82	99	294	423	733	20	9	
DN 40	41.0 × 1.50	62.0	90	93	135	335	464	774	19	14	
DN 50	53.0 × 1.50	74.0	90	99	135	341	470	780	27	14	
DN 65	70.0 × 2.00	96.0	125	125	170	382	511	996	27	24	
DN 80	85.0 × 2.00	111.0	125	117	170	390	519	1004	27	25	
DN 100	104.0 × 2.00	130.0	125	127	210	399	528	1013	27	34	
DN 125	129.0 × 2.00	155.0	150	171	260	555	684	1359	55	67	
DN 150	154.0 × 2.00	180.0	150	184	210	709	838	1513	55	85	
OD 1"	25.4 × 1.65	46.0	90	80	99	292	421	731	16	9	
OD 1 1/2"	38.1 × 1.65	59.0	90	91	135	337	466	776	18	13	
OD 2"	50.8 × 1.65	71.5	90	97	135	343	472	782	26	14	
OD 2 1/2"	63.5 × 1.65	90.0	125	122	170	386	515	1000	27	23	
OD 3"	76.2 × 1.65	103.0	125	113	170	393	522	1007	26	24	
OD 4"	101.6 × 2.11	127.5	125	125	210	401	530	1015	26	34	
OD 6"	152.4 × 2.77	177.0	150	185	210	708	837	1512	55	85	
IPS 2"	60.3 × 2.00	81.0	114.3	102	99	338	467	777	27	15	
IPS 3"	88.9 × 2.30	115.0	152.5	119	170	388	517	1002	27	24	
IPS 4"	114.3 × 2.30	140.0	152.5	132	210	394	523	1008	27	36	
IPS 6"	168.2 × 2.70	192.0	152.5	190	210	702	831	1506	55	86	

Please note: The following clearances are required for demounting the additional disc: DN 25–50: 50 mm, DN 65–100: 80 mm DN 125–150: 110 mm

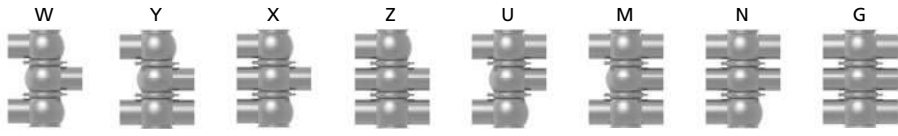
Position	Description of the order code for the standard version		
1	Valve type Y VARIVENT® double-seat valve		
2	Housing combinations 		
3	Supplement to the valve type Reserved for options		
4/5	Nominal width (upper housing / lower housing)		
	DN 25	OD 1"	
	DN 40	OD 1 ½"	
	DN 50	OD 2"	IPS 2"
	DN 65	OD 2 ½"	
	DN 80	OD 3"	IPS 3"
	DN 100	OD 4"	IPS 4"
	DN 125		
	DN 150	OD 6"	IPS 6"
6	Actuator type S Air/Spring		
7	Non-actuated position Z Spring-to-close (NC)		
8	Standard configuration with 6 bar air supply pressure for 5 bar product pressure (higher pressures on request)		
	Actuator (spring-to-close)	For nominal widths	
	AA	DN 25, OD 1"	
	CB	DN 40, DN 50, OD 1 ½", OD 2", IPS 2"	
	DD	DN 65, DN 80, OD 2 ½", OD 3", IPS 3"	
	EF	DN 100, OD 4", IPS 4"	
	SH6	DN 125	
	TK6	DN 150, OD 6", IPS 6"	
9	Valve seat version (upper housing / lower housing) L0 Loose seat ring/Clamp connection		
10	Seal material in contact with the product		
	1	EPDM (FDA)	
	2	FKM (FDA)	
	3	HNBR (FDA); (up to DN 100, OD 4", IPS OD 4")	
11	Surface quality of the housing		
	1	Inside Ra ≤ 1.2 µm, outside matte blasted (IPS)	
	2	Inside Ra ≤ 0.8 µm, outside matte blasted (DN, OD)	
12	Connection fittings N Welding end		
13	Accessories /52 Adhesive ID tag		
+			
14-19	Air connection / Control and feedback system		
	00000M	Metric for air hose Ø 6/4 mm	
	00000Z	Inch for air hose Ø OD ¼" (6.35/4.35 mm)	
	XXXXX	Order code for different control and feedback systems see section 9	



The code is composed as following, depending on the chosen configuration:

Position	1	2	3	4/5	6	7	8	9	10	11	12	13	14 to 19
Code	Y			/	S	Z		L0			N	/52	

For order codes differing from the standard version, please refer to section 7 (options).





Technical data of the standard version		
Material in contact with the product	1.4404/AISI 316 L	
Material not in contact with the product	1.4301/AISI 304	
Seal material in contact with the product	EPDM, FKM, HNBR	
Ambient temperature	0 to 45 °C	
Air supply pressure	6 bar (87 psi)	
Product pressure	5 bar (73 psi)	
Surface in contact with the product	DN, OD	Ra ≤ 0.8 µm
	IPS	Ra ≤ 1.2 µm
External housing surface	Matte blasted	
Control and feedback system	Connection 0 (without control top)	
Actuator type	Pneumatic actuator air/spring	
Connection fittings	Welding end	
Identification	Adhesive ID tag	
Valve seat version	Clamped seat ring	
Certificates	 	

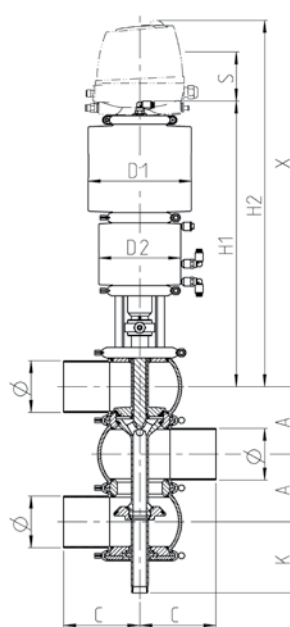

Nominal width	Pipe		Housing			Actuator		Dimensions			Valve	
	Ø [mm]		A [mm]	C [mm]	K [mm]	D1 [mm]	D2 [mm]	H1 [mm]	H2 [mm]	Extension X [mm]	Stroke S [mm]	Weight [kg]
DN 25	29.0 × 1.50		50.0	90	82	110	110	412.0	541.0	851.0	20	15
DN 40	41.0 × 1.50		62.0	90	93	135	110	426.0	555.0	865.0	19	18
DN 50	53.0 × 1.50		74.0	90	99	135	110	424.0	553.0	863.0	27	18
DN 65	70.0 × 2.00		96.0	125	125	170	135	465.0	594.0	1079.0	27	29
DN 80	85.0 × 2.00		111.0	125	117	170	135	472.5	601.5	1086.5	27	30
DN 100	104.0 × 2.00		130.0	125	127	210	170	482.0	611.0	1096.0	27	42
DN 125	129.0 × 2.00		155.0	150	171	260	210	662.5	791.5	1466.5	55	81
DN 150	154.0 × 2.00		180.0	150	184	210	210	816.0	945.0	1620.0	55	103
OD 1"	25.4 × 1.65		46.0	90	80	110	110	414.0	543.0	853.0	16	15
OD 1 ½"	38.1 × 1.65		59.0	90	91	135	110	427.5	556.5	866.5	18	18
OD 2"	50.8 × 1.65		71.5	90	97	135	110	425.3	554.3	864.3	26	18
OD 2 ½"	63.5 × 1.65		90.0	125	122	170	135	468.0	597.0	1082.0	27	29
OD 3"	76.2 × 1.65		103.0	125	113	170	135	476.5	605.5	1090.5	26	29
OD 4"	101.6 × 2.11		127.5	125	125	210	170	483.3	612.3	1097.3	26	42
OD 6"	152.4 × 2.77		177.0	150	185	210	210	866.0	995.0	1670.0	55	103
IPS 2"	60.3 × 2.00		81.0	114.3	102	135	110	417.5	546.5	856.5	27	19
IPS 3"	88.9 × 2.30		115.0	152.5	119	170	135	470.5	599.5	1084.5	27	29
IPS 4"	114.3 × 2.30		140.0	152.5	132	210	170	477.0	606.0	1091.0	27	43
IPS 6"	168.2 × 2.70		192.0	152.5	190	210	210	810.0	939.0	1614.0	55	100

Please note: The following clearances are required for demounting the additional disc: DN 25–50: 50 mm, DN 65–100: 80 mm DN 125–150: 110 mm

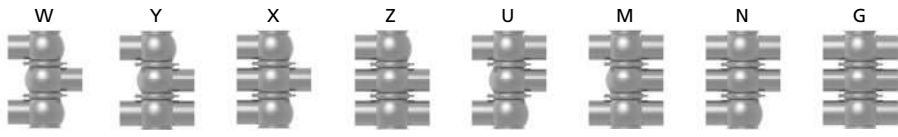
Position	Description of the order code for the standard version																								
1	Valve type Y VARIVENT® double-seat valve																								
2	Housing combinations 																								
3	Supplement to the valve type L With lifting actuator and spray cleaning C With lifting actuator without spray cleaning																								
4/5	Nominal width (upper housing / lower housing) <table border="1"> <tr><td>DN 25</td><td>OD 1"</td><td></td></tr> <tr><td>DN 40</td><td>OD 1 ½"</td><td></td></tr> <tr><td>DN 50</td><td>OD 2"</td><td>IPS 2"</td></tr> <tr><td>DN 65</td><td>OD 2 ½"</td><td></td></tr> <tr><td>DN 80</td><td>OD 3"</td><td>IPS 3"</td></tr> <tr><td>DN 100</td><td>OD 4"</td><td>IPS 4"</td></tr> <tr><td>DN 125</td><td></td><td></td></tr> <tr><td>DN 150</td><td>OD 6"</td><td>IPS 6"</td></tr> </table>	DN 25	OD 1"		DN 40	OD 1 ½"		DN 50	OD 2"	IPS 2"	DN 65	OD 2 ½"		DN 80	OD 3"	IPS 3"	DN 100	OD 4"	IPS 4"	DN 125			DN 150	OD 6"	IPS 6"
DN 25	OD 1"																								
DN 40	OD 1 ½"																								
DN 50	OD 2"	IPS 2"																							
DN 65	OD 2 ½"																								
DN 80	OD 3"	IPS 3"																							
DN 100	OD 4"	IPS 4"																							
DN 125																									
DN 150	OD 6"	IPS 6"																							
6	Actuator type S Air/Spring																								
7	Non-actuated position Z Spring-to-close (NC)																								
8	Standard configuration with 6 bar air supply pressure for 5 bar product pressure (higher pressures on request) <table border="1"> <thead> <tr> <th>Actuator (spring-to-close)</th> <th>/ Lifting actuator</th> <th>For nominal widths</th> </tr> </thead> <tbody> <tr> <td>BA</td> <td>/BLB</td> <td>DN 25, OD 1"</td> </tr> <tr> <td>CB</td> <td>/BLB</td> <td>DN 40, DN 50, OD 1 ½", OD 2", IPS 2"</td> </tr> <tr> <td>DD</td> <td>/CLB</td> <td>DN 65, DN 80, OD 2 ½", OD 3", IPS 3"</td> </tr> <tr> <td>EF</td> <td>/DLB</td> <td>DN 100, OD 4", IPS 4"</td> </tr> <tr> <td>SH6</td> <td>/EL6</td> <td>DN 125</td> </tr> <tr> <td>TK6</td> <td>/EL6</td> <td>DN 150, OD 6", IPS 6"</td> </tr> </tbody> </table>	Actuator (spring-to-close)	/ Lifting actuator	For nominal widths	BA	/BLB	DN 25, OD 1"	CB	/BLB	DN 40, DN 50, OD 1 ½", OD 2", IPS 2"	DD	/CLB	DN 65, DN 80, OD 2 ½", OD 3", IPS 3"	EF	/DLB	DN 100, OD 4", IPS 4"	SH6	/EL6	DN 125	TK6	/EL6	DN 150, OD 6", IPS 6"			
Actuator (spring-to-close)	/ Lifting actuator	For nominal widths																							
BA	/BLB	DN 25, OD 1"																							
CB	/BLB	DN 40, DN 50, OD 1 ½", OD 2", IPS 2"																							
DD	/CLB	DN 65, DN 80, OD 2 ½", OD 3", IPS 3"																							
EF	/DLB	DN 100, OD 4", IPS 4"																							
SH6	/EL6	DN 125																							
TK6	/EL6	DN 150, OD 6", IPS 6"																							
9	Valve seat version (upper housing / lower housing) L0 Loose seat ring/Clamp connection																								
10	Seal material in contact with the product 1 EPDM (FDA) 2 FKM (FDA) 3 HNBR (FDA); (up to DN 100, OD 4", IPS OD 4")																								
11	Surface quality of the housing 1 Inside Ra ≤ 1.2 µm, outside matte blasted (IPS) 2 Inside Ra ≤ 0.8 µm, outside matte blasted (DN, OD)																								
12	Connection fittings N Welding end																								
13	Accessories /52 Adhesive ID tag																								
+																									
14-19	Air connection / Control and feedback system 00000M Metric for air hose Ø 6/4 mm 00000Z Inch for air hose Ø OD ¼" (6.35/4.35 mm) XXXXX Order code for different control and feedback systems see section 9																								

The code is composed as following, depending on the chosen configuration:

Position	1	2	3	4/5	6	7	8	9	10	11	12	13	14 to 19
Code	Y			/	S	Z	/	L0			N	/52	+ [] [] [] [] [] []

For order codes differing from the standard version, please refer to section 7 (options).





VARIVENT®

The VARIVENT® modular system has many options available. Please refer to the options section (section 7) for information about these.

Sizes	
Tank bottom valves	
	DN 25–DN 150
	OD 1" –OD 6"
	IPS 2" –IPS 6"

Application examples

VARIVENT® tank bottom valves are used for shutting off pipelines at tanks or containers. Various housing connections can be welded directly into the tank bottom, flush mounted into the tank bottom wall.

Simple tank shut-off valves with only one sealing surface between the tank and pipeline are available, as well as mixproof, radial sealing tank bottom valves.

Simple tank shut-off valves are used if the tank is operated with separate filling and emptying lines. It is not possible to clean the pipeline while the tank is in process.

Mixproof tank shut-off valves are used if the tank is operated with common filling and emptying lines. Mixproof separation between the pipeline and the inside of the tank allows the pipeline to be cleaned while the process in the tank continues.

In the classic variant, the mixproof tank shut-off valve separates the process in the tank from the supply to the following valve matrix, meaning that the tanks can be filled, emptied and cleaned flexibly and in parallel with one another.

For some time now, mixproof tank bottom valves have been installed horizontally on a special connection unit directly below the tank (ECO-MATRIX™). In this case, the process lines do not converge in a valve matrix, instead they are routed directly underneath the tanks in order to save space.

Mixproof separation

Generally speaking, the mixproof variant is selected if the tank is operated with a common filling and emptying line. The mixproof valve makes it possible to clean the pipeline while the product in the tank is undergoing the required process.

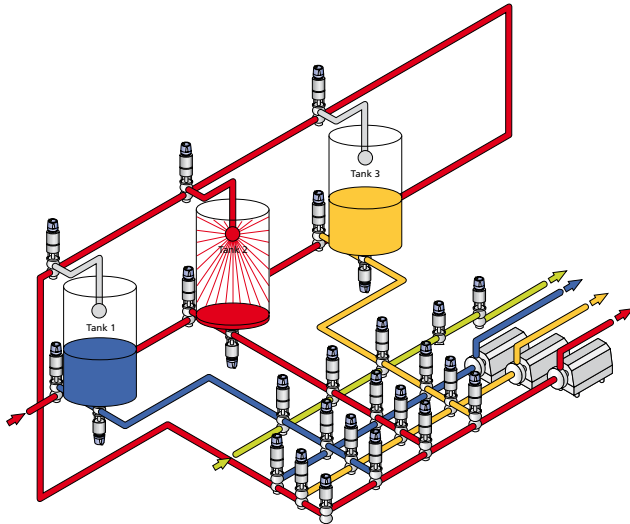

When the valve is closed (non-actuated position), there are always two seals between the two fluids in the mixproof variant. If one seal is defective, the resulting leakage can be deliberately channelled out of the leakage housing into the periphery. This method enables that there cannot be any mixture between a tank and a pipeline.

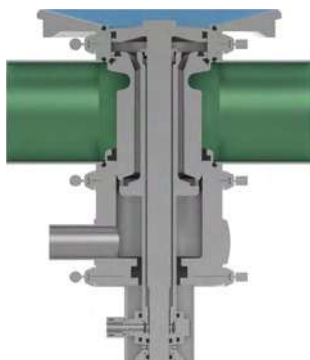

Mixproof separation by two seals

Tank connections

Various possibilities are available for connecting VARIVENT® tank valves to the tank. Tank connection type T is used for installing valves on the tank bottom. Tank connection type U is preferred for lateral, horizontal installation of valves on the tank wall.



Tank connection T



Tank connection U

Cleaning the leakage chamber

Lifting actuator (type T_RC, T_RL)

Double-seat bottom valves type T_RC are equipped with a lifting actuator which enables individual lifting of a single valve disc during cleaning of the pipe or the tank.

The cleaning media passes the seal of the lifted valve disc, cleans the leakage chamber and then flows out through the leakage outlet into the periphery. This way, it is possible to clean all surfaces that come into contact with the product, including the surfaces of the valve disc seals.

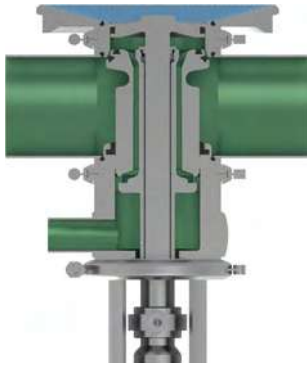

If there is cleaning media in the pipeline, the lower valve disc (double disc lift) can be lifted into the pipeline to allow the surface of the seal and the leakage chamber to be cleaned.

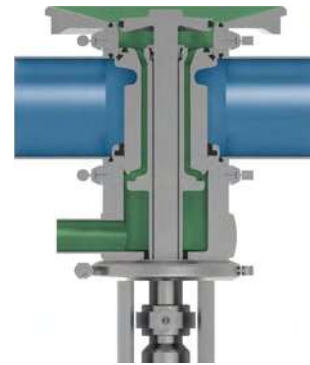

The upper valve disc (valve disc lift) of the bottom valve can be lifted in the direction of the tank. This makes it possible to clean the seal surfaces and the leakage chamber. For this purpose, the liquid should be stored in advance at an adequate level in the tank.

Spray cleaning (type T_R, T_RL)

The valves have a cleaning connection at the level of the lantern either on its own (type T_R) or additionally alongside the lifting actuator (type T_RL). This connection allows the leakage chamber to be supplied with cleaning media from an external source in order to clean this chamber (in addition to the lifting actuator) by means of an integrated spray nozzle. After that, the cleaning media flows through the leakage outlet without pressure into the periphery. Cleaning takes place with the valve closed, which means the seal surfaces in contact are not touched during cleaning.

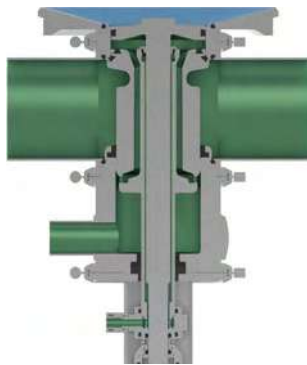

Spray cleaning with tank bottom valve

This way, the leakage chamber can be cleaned independently from the pipe cleaning. In addition, this allows interim flushing to occur before or after a switching procedure of the valve.

If valves are equipped with both a lifting actuator and the possibility of external spray cleaning, then spray cleaning is only used for interim flushing during the individual switching procedures, whereas thorough cleaning is performed by lifting.

Periphery

For spray cleaning via the external connection in the lantern, it is necessary to have feed valves in the periphery to channel the cleaning media to the cleaning connection of the double-seat valve. For this purpose feed valves with a relatively small nominal width are used on the pipeline carrying the cleaning media. Each feed valve generally supplies several cleaning connections of double-seat valves. It should be noted that all connected double-seat valves must have an adequate supply of cleaning media during cleaning. As a rule of thumb, no more than six double-seat valves should be supplied from one feed valve.

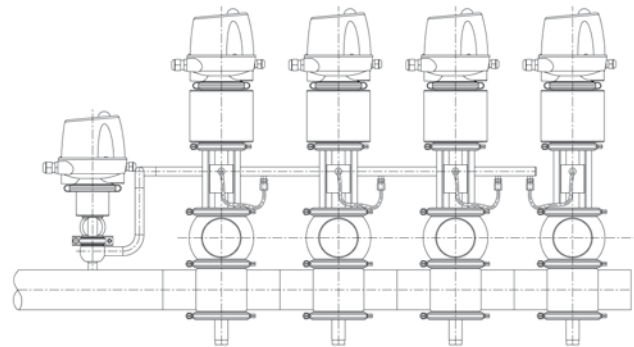

Application example of a feed valve

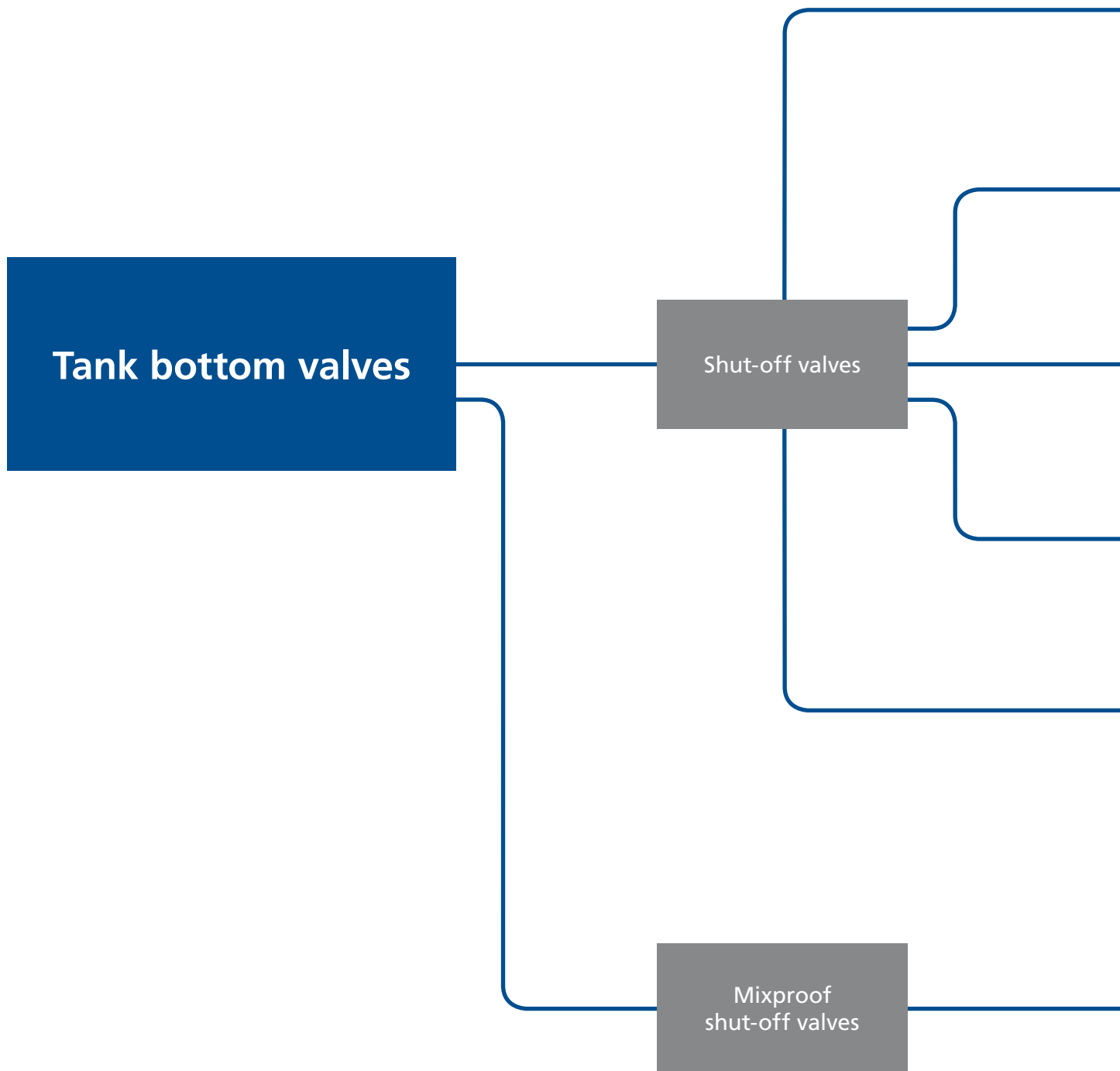

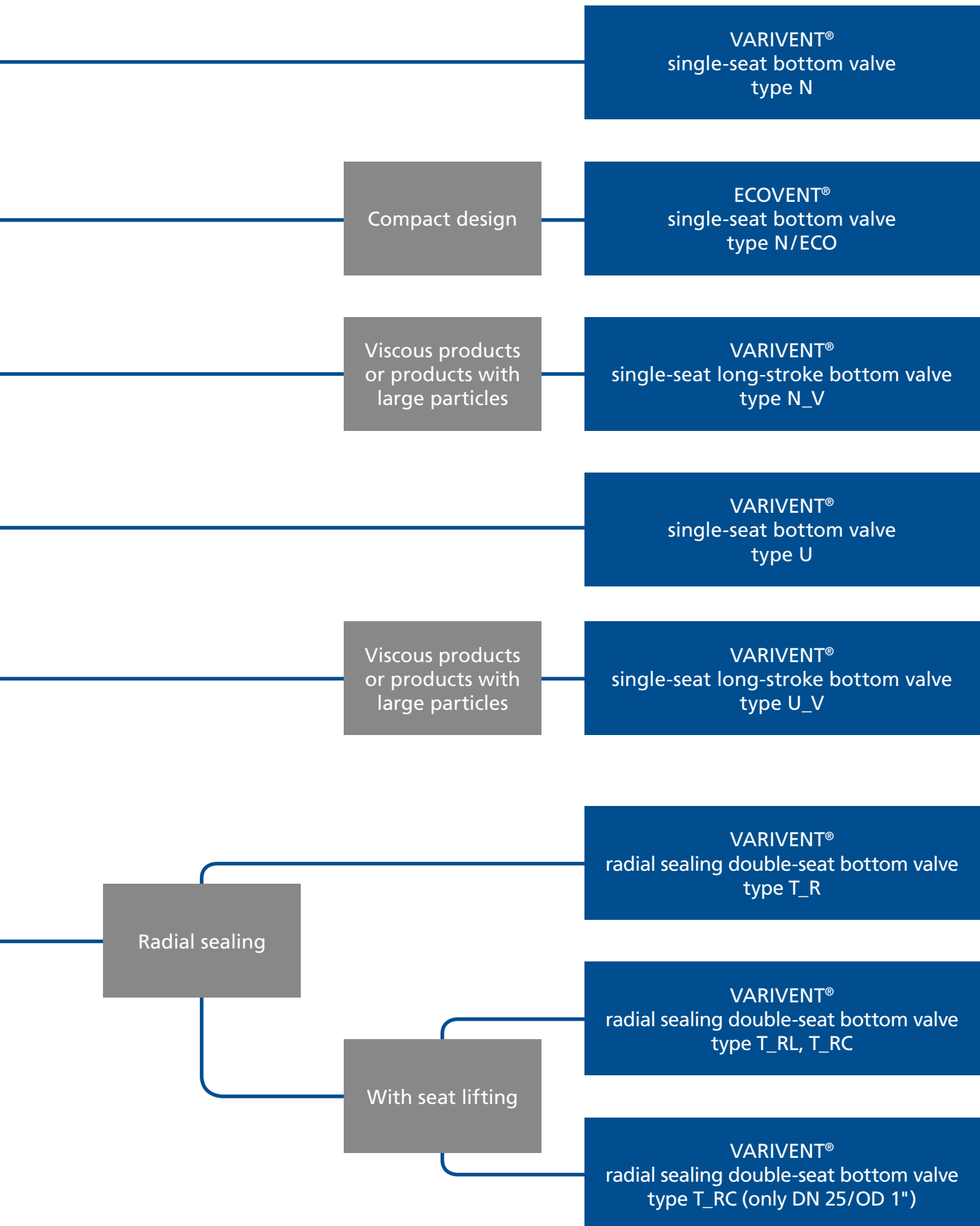



Technical data of the standard version		
Recommended flow direction	Filling, emptying	
Material in contact with the product	1.4404/AISI 316 L	
Material not in contact with the product	1.4301/AISI 304	
Seal material in contact with the product	EPDM, FKM, HNBR	
Ambient temperature	0 to 45 °C	
Air supply pressure	6 bar (87 psi)	
Product pressure	5 bar (73 psi)	
Surface in contact with the product	DN, OD	Ra ≤ 0.8 µm
	IPS	Ra ≤ 1.2 µm
External housing surface	Matte blasted	
Control and feedback system	Connection 0 (without control top)	
Actuator type	Pneumatic actuator air/spring	
Connection fittings	Welding end	
Identification	Adhesive ID tag	
Valve seat version	Clamped seat ring	
Certificates		

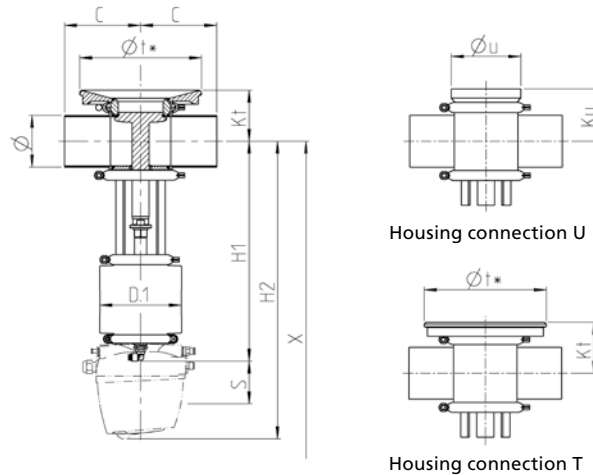

Nominal width	Pipe Ø [mm]	Housing C [mm]	Actuator D1 [mm]	Dimensions			Housing connection U		Housing connection T		Valve	
				H1 [mm]	H2 [mm]	Extension X [mm]	Ku [mm]	Øu [mm]	Kt [mm]	Øt* [mm]	Stroke [mm]	Weight [kg]
DN 25	29.0 × 1.50	90	99	294	423	508	50.0	70 × 2.0	49.0	145	16	7
DN 40	41.0 × 1.50	90	110	335	464	549	56.0	85 × 2.0	55.5	165	18	9
DN 50	53.0 × 1.50	90	110	341	470	555	62.0	85 × 2.0	61.5	165	30	9
DN 65	70.0 × 2.00	125	135	352	481	626	78.0	114 × 2.5	76.0	200	30	14
DN 80	85.0 × 2.00	125	135	360	489	634	85.5	114 × 2.5	83.5	200	30	15
DN 100	104.0 × 2.00	125	170	399	528	673	95.0	154 × 2.0	92.5	225	30	21
DN 125	129.0 × 2.00	150	260	555	684	884	107.5	184 × 3.0	-	-	60	48
DN 150	154.0 × 2.00	150	260	579	708	908	120.0	212 × 4.0	-	-	60	53
OD 1"	25.4 × 1.65	90	99	292	421	506	48.0	70 × 2.0	47.0	145	12	7
OD 1 1/2"	38.1 × 1.65	90	110	337	466	551	54.5	85 × 2.0	54.0	165	18	9
OD 2"	50.8 × 1.65	90	110	343	472	557	60.8	85 × 2.0	60.3	165	30	9
OD 2 1/2"	63.5 × 1.65	125	135	356	485	630	75.0	114 × 2.5	73.0	200	31	14
OD 3"	76.2 × 1.65	125	135	363	492	637	81.5	114 × 2.5	79.5	200	29	14
OD 4"	101.6 × 2.11	125	170	401	530	675	93.8	154 × 2.0	91.3	225	30	21
OD 6"	152.4 × 2.77	150	260	578	707	907	118.5	212 × 4.0	-	-	60	54
IPS 2"	60.3 × 2.00	114.3	110	338	467	552	65.5	85 × 2.0	65.0	165	30	10
IPS 3"	88.9 × 2.30	152.5	135	358	487	632	87.5	114 × 2.5	85.5	200	30	15
IPS 4"	114.3 × 2.30	152.5	170	394	523	668	100.0	154 × 2.0	97.5	225	30	22
IPS 6"	168.2 × 2.70	152.5	260	573	702	902	126.0	212 × 4.0	-	-	60	54

* The maximum wall thickness of the tank can be 8 mm.

Position	Description of the order code for the standard version																								
1	Valve type N VARIVENT® single-seat bottom valve																								
2	Housing combinations 																								
3	Supplement to the valve type Reserved for options																								
4/5	Nominal width (upper housing / lower housing) <table border="1"> <tr> <td>DN 25</td> <td>OD 1"</td> <td></td> </tr> <tr> <td>DN 40</td> <td>OD 1 ½"</td> <td></td> </tr> <tr> <td>DN 50</td> <td>OD 2"</td> <td>IPS 2"</td> </tr> <tr> <td>DN 65</td> <td>OD 2 ½"</td> <td></td> </tr> <tr> <td>DN 80</td> <td>OD 3"</td> <td>IPS 3"</td> </tr> <tr> <td>DN 100</td> <td>OD 4"</td> <td>IPS 4"</td> </tr> <tr> <td>DN 125</td> <td></td> <td></td> </tr> <tr> <td>DN 150</td> <td>OD 6"</td> <td>IPS 6"</td> </tr> </table>	DN 25	OD 1"		DN 40	OD 1 ½"		DN 50	OD 2"	IPS 2"	DN 65	OD 2 ½"		DN 80	OD 3"	IPS 3"	DN 100	OD 4"	IPS 4"	DN 125			DN 150	OD 6"	IPS 6"
DN 25	OD 1"																								
DN 40	OD 1 ½"																								
DN 50	OD 2"	IPS 2"																							
DN 65	OD 2 ½"																								
DN 80	OD 3"	IPS 3"																							
DN 100	OD 4"	IPS 4"																							
DN 125																									
DN 150	OD 6"	IPS 6"																							
6	Actuator type S Air/Spring																								
7	Non-actuated position Z Spring-to-close (NC) A Spring-to-open (NO)																								
8	Standard configuration with 6 bar air supply pressure for 5 bar product pressure (higher pressures on request) <table border="1"> <thead> <tr> <th>Actuator (spring-to-close)</th> <th>Actuator (spring-to-open)</th> <th>For nominal widths</th> </tr> </thead> <tbody> <tr> <td>AA</td> <td>AA</td> <td>DN 25, OD 1"</td> </tr> <tr> <td>BB</td> <td>BA</td> <td>DN 40, DN 50, OD 1 ½", OD 2", IPS 2"</td> </tr> <tr> <td>CD</td> <td>CB</td> <td>DN 65, DN 80, OD 2 ½", OD 3", IPS 3"</td> </tr> <tr> <td>DF</td> <td>DD</td> <td>DN 100, OD 4", IPS 4"</td> </tr> <tr> <td>SH6</td> <td>EF6</td> <td>DN 25</td> </tr> <tr> <td>SK6</td> <td>SG6</td> <td>DN 150, OD 6", IPS 6"</td> </tr> </tbody> </table>	Actuator (spring-to-close)	Actuator (spring-to-open)	For nominal widths	AA	AA	DN 25, OD 1"	BB	BA	DN 40, DN 50, OD 1 ½", OD 2", IPS 2"	CD	CB	DN 65, DN 80, OD 2 ½", OD 3", IPS 3"	DF	DD	DN 100, OD 4", IPS 4"	SH6	EF6	DN 25	SK6	SG6	DN 150, OD 6", IPS 6"			
Actuator (spring-to-close)	Actuator (spring-to-open)	For nominal widths																							
AA	AA	DN 25, OD 1"																							
BB	BA	DN 40, DN 50, OD 1 ½", OD 2", IPS 2"																							
CD	CB	DN 65, DN 80, OD 2 ½", OD 3", IPS 3"																							
DF	DD	DN 100, OD 4", IPS 4"																							
SH6	EF6	DN 25																							
SK6	SG6	DN 150, OD 6", IPS 6"																							
9	Valve seat version (upper housing / lower housing) L0 Loose seat ring/Clamp connection																								
10	Seal material in contact with the product 1 EPDM (FDA) 2 FKM (FDA) 3 HNBR (FDA); (up to DN 100, OD 4", IPS OD 4")																								
11	Surface quality of the housing 1 Inside Ra ≤ 1.2 µm, outside matte blasted (IPS) 2 Inside Ra ≤ 0.8 µm, outside matte blasted (DN, OD)																								
12	Connection fittings N Welding end																								
13	Accessories /T Housing connection T (up to DN 100, OD 4", IPS 4") /U Housing connection U /52 Adhesive ID tag																								
+																									
14–19	Air connection / Control and feedback system 00000M Metric for air hose Ø 6/4 mm 00000Z Inch for air hose Ø OD ¼" (6.35/4.35 mm) XXXXX Order code for different control and feedback systems see section 9																								

* Optionally with housing connection flange U or housing connection flange T (see position 13)

The code is composed as following, depending on the chosen configuration:

Position	1	2	3	4/5	6	7	8	9	10	11	12	13	14 to 19
Code	N			/	S			L0			N	/52	

For order codes differing from the standard version, please refer to section 7 (options).





Technical data of the standard version	
Recommended flow direction	Filling, emptying
Material in contact with the product	1.4404/AISI 316 L
Material not in contact with the product	1.4301/AISI 304
Seal material in contact with the product	EPDM, FKM, HNBR
Ambient temperature	0 to 45 °C
Air supply pressure	6 bar (87 psi)
Product pressure	5 bar (73 psi)
Surface in contact with the product	Ra ≤ 0.8 µm
External housing surface	Matte blasted
Control and feedback system	Connection 0 (without control top)
Actuator type	Pneumatic actuator air/spring
Connection fittings	Welding end
Identification	Adhesive ID tag
Valve seat version	Clamped seat ring
Certificates	

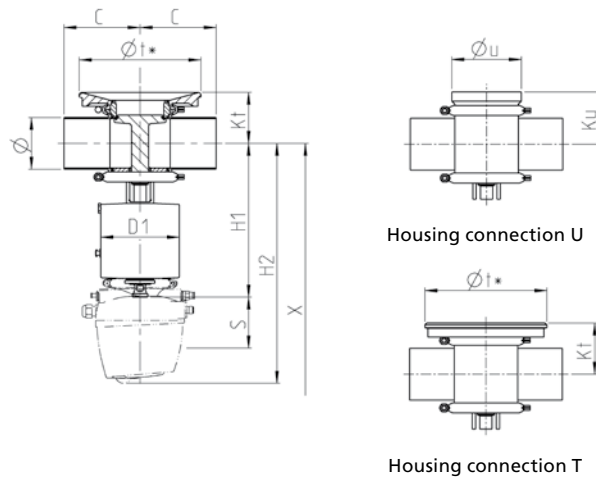

Nominal width	Pipe Ø [mm]	Housing C [mm]	Actuator D1 [mm]	Dimensions			Housing connection U		Housing connection T		Valve	
				H1 [mm]	H2 [mm]	Extension X [mm]	Ku [mm]	Øu [mm]	Kt [mm]	Øt* [mm]	Stroke [mm]	Weight [kg]
DN 25	29.0 × 1.50	90	99	209	338	423	50.0	70 × 2.0	49.0	145	16.0	6
DN 40	41.0 × 1.50	90	110	243	372	457	56.0	85 × 2.0	55.5	165	20.0	7
DN 50	53.0 × 1.50	90	110	249	378	463	62.0	85 × 2.0	61.5	165	28.0	8
DN 65	70.0 × 2.00	125	135	257	386	531	78.0	114 × 2.5	76.0	200	28.0	12
DN 80	85.0 × 2.00	125	135	264	393	538	85.5	114 × 2.5	83.5	200	28.0	12
DN 100	104.0 × 2.00	125	170	274	403	548	95.0	154 × 2.0	92.5	225	28.0	17
OD 1"	25.4 × 1.65	90	99	207	336	421	48.0	70 × 2.0	47.0	145	12.0	6
OD 1 ½"	38.1 × 1.65	90	110	241	370	455	54.5	85 × 2.0	54.0	165	17.0	7
OD 2"	50.8 × 1.65	90	110	248	377	462	60.8	85 × 2.0	60.3	165	25.5	7
OD 2 ½"	63.5 × 1.65	125	135	254	383	528	75.0	114 × 2.5	73.0	200	22.0	11
OD 3"	76.2 × 1.65	125	135	260	389	534	81.5	114 × 2.5	79.5	200	20.0	12
OD 4"	101.6 × 2.11	125	170	273	402	547	93.8	154 × 2.0	91.3	225	25.5	17

* The maximum wall thickness of the tank can be 8 mm.

Position	Description of the order code for the standard version															
1	Valve type N ECOVENT® single-seat bottom valve															
2	Housing combinations F* D* 															
3	Supplement to the valve type /ECO															
4/5	Nominal width (upper housing / lower housing) DN 25 OD 1" DN 40 OD 1 1/2" DN 50 OD 2" DN 65 OD 2 1/2" DN 80 OD 3" DN 100 OD 4"															
6	Actuator type E Air/Spring															
7	Non-actuated position Z Spring-to-close (NC) A Spring-to-open (NO)															
8	Standard configuration with 6 bar air supply pressure for 5 bar product pressure (higher pressures on request) <table border="1"> <thead> <tr> <th>Actuator (spring-to-close)</th> <th>Actuator (spring-to-open)</th> <th>For nominal widths</th> </tr> </thead> <tbody> <tr> <td>EAA</td> <td>EAA</td> <td>DN 25, OD 1"</td> </tr> <tr> <td>EBB</td> <td>EBA</td> <td>DN 40, DN 50, OD 1 1/2", OD 2"</td> </tr> <tr> <td>ECD</td> <td>ECB</td> <td>DN 65, DN 80, OD 2 1/2", OD 3"</td> </tr> <tr> <td>EDF</td> <td>EDD</td> <td>DN 100, OD 4"</td> </tr> </tbody> </table>	Actuator (spring-to-close)	Actuator (spring-to-open)	For nominal widths	EAA	EAA	DN 25, OD 1"	EBB	EBA	DN 40, DN 50, OD 1 1/2", OD 2"	ECD	ECB	DN 65, DN 80, OD 2 1/2", OD 3"	EDF	EDD	DN 100, OD 4"
Actuator (spring-to-close)	Actuator (spring-to-open)	For nominal widths														
EAA	EAA	DN 25, OD 1"														
EBB	EBA	DN 40, DN 50, OD 1 1/2", OD 2"														
ECD	ECB	DN 65, DN 80, OD 2 1/2", OD 3"														
EDF	EDD	DN 100, OD 4"														
9	Valve seat version (upper housing / lower housing) L0 Loose seat ring/Clamp connection															
10	Seal material in contact with the product 1 EPDM (FDA) 2 FKM (FDA) 3 HNBR (FDA)															
11	Surface quality of the housing 2 Inside Ra ≤ 0.8 µm, outside matte blasted															
12	Connection fittings N Welding end															
13	Accessories /T Housing connection T (up to DN 100, OD 4") /U Housing connection U /52 Adhesive ID tag															
+																
14-19	Air connection / Control and feedback system 00000M Metric for air hose Ø 6/4 mm 00000Z Inch for air hose Ø OD 1/4" (6.35/4.35 mm) XXXXX Order code for different control and feedback systems see section 9															

* Optionally with housing connection flange U or housing connection flange T (see position 13)

The code is composed as following, depending on the chosen configuration:

Position	1	2	3	4/5	6	7	8	9	10	11	12	13	14 to 19
Code	N		/ECO	/	E			L0			N	/52	

For order codes differing from the standard version, please refer to section 7 (options).





Technical data of the standard version	
Recommended flow direction	Filling, emptying
Material in contact with the product	1.4404/AISI 316 L
Material not in contact with the product	1.4301/AISI 304
Seal material in contact with the product	EPDM, FKM, HNBR
Ambient temperature	0 to 45 °C
Air supply pressure	4.8 bar (70 psi)
Product pressure	DN 65–DN 80 OD 2 ½" –OD 3" 10 bar (145 psi)
	DN 100 OD 4" 5.2 bar (75 psi)
Surface in contact with the product	Ra ≤ 0.8 µm
External housing surface	Matte blasted
Control and feedback system	Connection 0 (without control top)
Actuator type	Pneumatic actuator air/spring
Connection fittings	Welding end
Identification	Adhesive ID tag
Valve seat version	Clamped seat ring
Certificates	

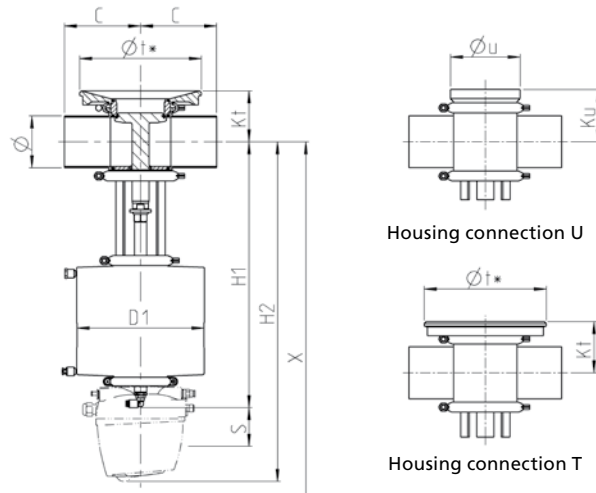

Nominal width	Pipe Ø [mm]	Housing C [mm]	Actuator D1 [mm]	Dimensions			Housing connection U		Housing connection T		Valve	
				H1 [mm]	H2 [mm]	Extension X [mm]	Ku [mm]	Øu [mm]	Kt [mm]	Øt* [mm]	Stroke [mm]	Weight [kg]
DN 65	70.0 × 2.00	125	210	421	550	695	78.0	114 × 2.5	76.0	200	41.5	24
DN 80	85.0 × 2.00	125	210	429	558	703	85.5	114 × 2.5	83.5	200	56.5	24
DN 100	104.0 × 2.00	125	210	438	567	712	95.0	154 × 2.0	92.5	225	60.0	27
OD 2 ½"	63.5 × 1.65	125	210	425	554	699	75.0	114 × 2.5	73.0	200	42.5	24
OD 3"	76.2 × 1.65	125	210	432	561	706	81.5	114 × 2.5	79.5	200	55.5	24
OD 4"	101.6 × 2.11	125	210	438	567	712	93.8	154 × 2.0	91.3	225	60.5	27

* The maximum wall thickness of the tank can be 8 mm.

Position	Description of the order code for the standard version
1	Valve type N VARIVENT® single-seat long-stroke bottom valve
2	Housing combinations 
3	Supplement to the valve type V Long-stroke
4/5	Nominal width (upper housing / lower housing) DN 65 OD 2 ½" DN 80 OD 3" DN 100 OD 4"
6	Actuator type L Air/spring, long stroke
7	Non-actuated position Z Spring-to-close (NC) A Spring-to-open (NO)
8	Standard configuration with 4.8 bar air supply pressure for 10 bar product pressure (DN 65–DN 80, OD 2 ½"–OD 3") or 5.2 bar (DN 100, OD 4") – (higher pressures on request) Actuator (spring-to-close) Actuator (spring-to-open) ZEF/V ZEF/V
9	Valve seat version (upper housing / lower housing) L0 Loose seat ring/Clamp connection
10	Seal material in contact with the product 1 EPDM (FDA) 2 FKM (FDA) 3 HNBR (FDA)
11	Surface quality of the housing 2 Inside Ra ≤ 0.8 µm, outside matte blasted
12	Connection fittings N Welding end
13	Accessories /T Housing connection T /U Housing connection U /52 Adhesive ID tag
+	
14–19	Air connection / Control and feedback system 00000M Metric for air hose Ø 6/4 mm 00000Z Inch for air hose Ø OD ¼" (6.35/4.35 mm) XXXXXX Order code for different control and feedback systems see section 9

* Optionally with housing connection flange U or housing connection flange T (see position 13)

The code is composed as following, depending on the chosen configuration:

Position	1	2	3	4/5	6	7	8	9	10	11	12	13	14 to 19				
Code	N		V	/	L		ZEF/V	L0			N	/52					

For order codes differing from the standard version, please refer to section 7 (options).





Technical data of the standard version		
Recommended flow direction	Filling, emptying	
Material in contact with the product	1.4404/AISI 316 L	
Material not in contact with the product	1.4301/AISI 304	
Seal material in contact with the product	EPDM, FKM, HNBR	
Ambient temperature	0 to 45 °C	
Air supply pressure	6 bar (87 psi)	
Product pressure	5 bar (73 psi)	
Surface in contact with the product	DN, OD	Ra ≤ 0.8 µm
	IPS	Ra ≤ 1.2 µm
External housing surface	Matte blasted	
Control and feedback system	Connection 0 (without control top)	
Actuator type	Pneumatic actuator air/spring	
Connection fittings	Welding end	
Identification	Adhesive ID tag	
Valve seat version	Clamped seat ring	
Certificates		

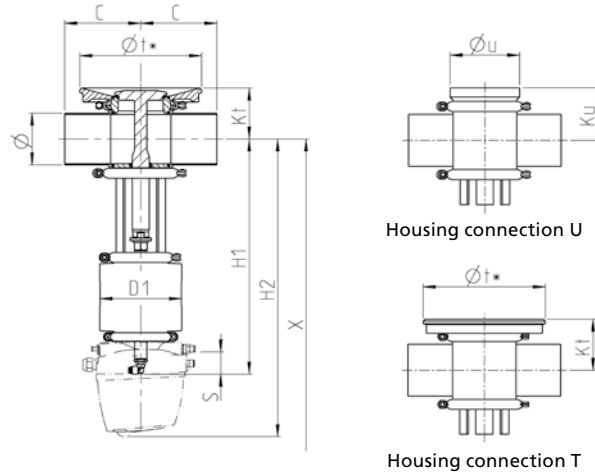

Nominal width	Pipe Ø [mm]	Housing C [mm]	Actuator D1 [mm]	Dimensions			Housing connection U		Housing connection T		Valve	
				H1 [mm]	H2 [mm]	Extension X [mm]	Ku [mm]	Øu [mm]	Kt [mm]	Øt* [mm]	Stroke [mm]	Weight [kg]
DN 25	29.0 × 1.50	90	99	294	423	200	50.0	70 × 2.0	49.0	145	18	7
DN 40	41.0 × 1.50	90	110	335	464	200	56.0	85 × 2.0	55.5	165	25	9
DN 50	53.0 × 1.50	90	110	341	470	200	62.0	85 × 2.0	61.5	165	29	10
DN 65	70.0 × 2.00	125	135	352	481	230	78.0	114 × 2.5	76.0	200	30	15
DN 80	85.0 × 2.00	125	135	360	489	230	85.5	114 × 2.5	83.5	200	30	15
DN 100	104.0 × 2.00	125	170	399	528	250	95.0	154 × 2.0	92.5	225	30	21
DN 125	129.0 × 2.00	150	260	555	684	300	107.5	184 × 3.0	-	-	60	48
DN 150	154.0 × 2.00	150	260	579	708	300	120.0	212 × 4.0	-	-	60	54
OD 1"	25.4 × 1.65	90	99	292	421	200	48.0	70 × 2.0	47.0	145	22	7
OD 1 ½"	38.1 × 1.65	90	110	337	466	200	54.5	85 × 2.0	54.0	165	25	9
OD 2"	50.8 × 1.65	90	110	343	472	200	60.8	85 × 2.0	60.3	165	28	10
OD 2 ½"	63.5 × 1.65	125	135	356	485	230	75.0	114 × 2.5	73.0	200	29	14
OD 3"	76.2 × 1.65	125	135	363	492	230	81.5	114 × 2.5	79.5	200	31	14
OD 4"	101.6 × 2.11	125	170	401	530	250	93.8	154 × 2.0	91.3	225	29	21
OD 6"	152.4 × 2.77	150	260	578	707	300	118.5	212 × 4.0	-	-	60	54
IPS 2"	60.3 × 2.00	114.3	110	338	467	200	65.5	85 × 2.0	65.0	165	29	10
IPS 3"	88.9 × 2.30	152.5	135	358	487	230	87.5	114 × 2.5	85.5	200	30	15
IPS 4"	114.3 × 2.30	152.5	170	394	523	250	100.0	154 × 2.0	97.5	225	30	22
IPS 6"	168.2 × 2.70	152.5	260	573	702	300	126.0	212 × 4.0	-	-	60	55

* The maximum wall thickness of the tank can be 8 mm.

Position	Description of the order code for the standard version																								
1	Valve type U VARIVENT® single-seat bottom valve																								
2	Housing combinations 																								
3	Supplement to the valve type Reserved for options																								
4/5	Nominal width (upper housing / lower housing) <table border="1"> <tr> <td>DN 25</td> <td>OD 1"</td> <td></td> </tr> <tr> <td>DN 40</td> <td>OD 1 ½"</td> <td></td> </tr> <tr> <td>DN 50</td> <td>OD 2"</td> <td>IPS 2"</td> </tr> <tr> <td>DN 65</td> <td>OD 2 ½"</td> <td></td> </tr> <tr> <td>DN 80</td> <td>OD 3"</td> <td>IPS 3"</td> </tr> <tr> <td>DN 100</td> <td>OD 4"</td> <td>IPS 4"</td> </tr> <tr> <td>DN 125</td> <td></td> <td></td> </tr> <tr> <td>DN 150</td> <td>OD 6"</td> <td>IPS 6"</td> </tr> </table>	DN 25	OD 1"		DN 40	OD 1 ½"		DN 50	OD 2"	IPS 2"	DN 65	OD 2 ½"		DN 80	OD 3"	IPS 3"	DN 100	OD 4"	IPS 4"	DN 125			DN 150	OD 6"	IPS 6"
DN 25	OD 1"																								
DN 40	OD 1 ½"																								
DN 50	OD 2"	IPS 2"																							
DN 65	OD 2 ½"																								
DN 80	OD 3"	IPS 3"																							
DN 100	OD 4"	IPS 4"																							
DN 125																									
DN 150	OD 6"	IPS 6"																							
6	Actuator type S Air/Spring																								
7	Non-actuated position Z Spring-to-close (NC) A Spring-to-open (NO)																								
8	Standard configuration with 6 bar air supply pressure for 5 bar product pressure (higher pressures on request) <table border="1"> <thead> <tr> <th>Actuator (spring-to-close)</th> <th>Actuator (spring-to-open)</th> <th>For nominal widths</th> </tr> </thead> <tbody> <tr> <td>AA</td> <td>AA</td> <td>DN 25, OD 1"</td> </tr> <tr> <td>BB</td> <td>BA</td> <td>DN 40, DN 50, OD 1 ½", OD 2", IPS 2"</td> </tr> <tr> <td>CD</td> <td>CB</td> <td>DN 65, DN 80, OD 2 ½", OD 3", IPS 3"</td> </tr> <tr> <td>DF</td> <td>DD</td> <td>DN 100, OD 4", IPS 4"</td> </tr> <tr> <td>SH6</td> <td>EF6</td> <td>DN 125</td> </tr> <tr> <td>SK6</td> <td>SG6</td> <td>DN 150, OD 6", IPS 6"</td> </tr> </tbody> </table>	Actuator (spring-to-close)	Actuator (spring-to-open)	For nominal widths	AA	AA	DN 25, OD 1"	BB	BA	DN 40, DN 50, OD 1 ½", OD 2", IPS 2"	CD	CB	DN 65, DN 80, OD 2 ½", OD 3", IPS 3"	DF	DD	DN 100, OD 4", IPS 4"	SH6	EF6	DN 125	SK6	SG6	DN 150, OD 6", IPS 6"			
Actuator (spring-to-close)	Actuator (spring-to-open)	For nominal widths																							
AA	AA	DN 25, OD 1"																							
BB	BA	DN 40, DN 50, OD 1 ½", OD 2", IPS 2"																							
CD	CB	DN 65, DN 80, OD 2 ½", OD 3", IPS 3"																							
DF	DD	DN 100, OD 4", IPS 4"																							
SH6	EF6	DN 125																							
SK6	SG6	DN 150, OD 6", IPS 6"																							
9	Valve seat version (upper housing / lower housing) L0 Loose seat ring/Clamp connection																								
10	Seal material in contact with the product 1 EPDM (FDA) 2 FKM (FDA) 3 HNBR (FDA); (up to DN 100, OD 4", IPS OD 4")																								
11	Surface quality of the housing 1 Inside Ra ≤ 1.2 µm, outside matte blasted (IPS) 2 Inside Ra ≤ 0.8 µm, outside matte blasted (DN, OD)																								
12	Connection fittings N Welding end																								
13	Accessories /T Housing connection T (up to DN 100, OD 4", IPS 4") /U Housing connection U /52 Adhesive ID tag																								
+																									
14–19	Air connection / Control and feedback system 00000M Metric for air hose Ø 6/4 mm 00000Z Inch for air hose Ø OD ¼" (6.35/4.35 mm) XXXXX Order code for different control and feedback systems see section 9																								

* Optionally with housing connection flange U or housing connection flange T (see position 13)

The code is composed as following, depending on the chosen configuration:

Position	1	2	3	4/5	6	7	8	9	10	11	12	13	14 to 19
Code	U			/	S			L0			N	/52	

For order codes differing from the standard version, please refer to section 7 (options).





Technical data of the standard version		
Recommended flow direction	Filling, emptying	
Material in contact with the product	1.4404/AISI 316 L	
Material not in contact with the product	1.4301/AISI 304	
Seal material in contact with the product	EPDM, FKM, HNBR	
Ambient temperature	0 to 45 °C	
Air supply pressure	4.8 bar (70 psi)	
Product pressure	DN 80	5 bar (73 psi)
	OD 3"	
	DN 100	5.6 bar (81 psi)
OD 4"		
Surface in contact with the product	Ra ≤ 0.8 µm	
External housing surface	Matte blasted	
Control and feedback system	Connection 0 (without control top)	
Actuator type	Pneumatic actuator air/spring	
Connection fittings	Welding end	
Identification	Adhesive ID tag	
Valve seat version	Clamped seat ring	
Certificates		

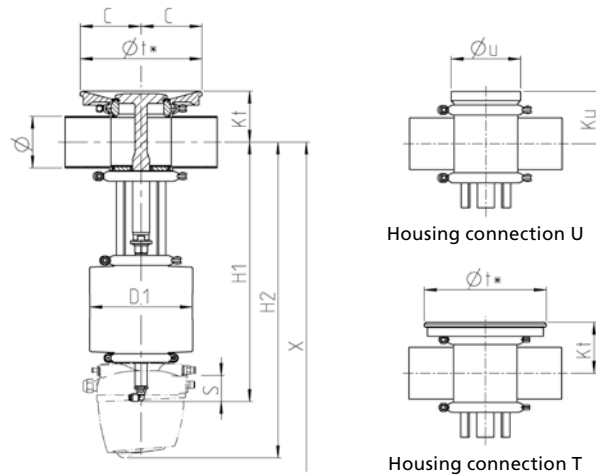

Nominal width	Pipe	Housing	Actuator	Dimensions			Housing connection U		Housing connection T		Valve	
	Ø [mm]	C [mm]	D1 [mm]	H1 [mm]	H2 [mm]	P [mm]	Ku [mm]	Øu [mm]	Kt [mm]	Øt* [mm]	Stroke [mm]	Weight [kg]
DN 80	85.0 × 2.00	125	170	390	519	230	85.5	114 × 2.5	83.5	200	40	18
DN 100	104.0 × 2.00	125	210	409	538	250	95.0	154 × 2.0	92.5	225	40	24
OD 3"	76.2 × 1.65	125	170	393	522	230	81.5	114 × 2.5	79.5	200	41	18
OD 4"	101.6 × 2.11	125	170	411	540	250	93.8	154 × 2.0	91.3	225	39	24

* The maximum wall thickness of the tank can be 8 mm.

Position	Description of the order code for the standard version									
1	Valve type U VARIVENT® single-seat long-stroke bottom valve									
2	Housing combinations 									
3	Supplement to the valve type V Long-stroke									
4/5	Nominal width (upper housing / lower housing) DN 80 OD 3" DN 100 OD 4"									
6	Actuator type S Air/Spring									
7	Non-actuated position Z Spring-to-close (NC) A Spring-to-open (NO)									
8	Standard configuration with 4.8 bar air supply pressure for 5 bar product pressure (DN 80, OD 3") or 5.6 bar (DN 100, OD 4") – (higher pressures on request) <table border="1"> <tr> <th>Actuator (spring-to-close)</th> <th>Actuator (spring-to-open)</th> <th>For nominal widths</th> </tr> <tr> <td>DD5</td> <td>DD5</td> <td>DN 80, OD 3"</td> </tr> <tr> <td>EF5</td> <td>EF5</td> <td>DN 100, OD 4"</td> </tr> </table>	Actuator (spring-to-close)	Actuator (spring-to-open)	For nominal widths	DD5	DD5	DN 80, OD 3"	EF5	EF5	DN 100, OD 4"
Actuator (spring-to-close)	Actuator (spring-to-open)	For nominal widths								
DD5	DD5	DN 80, OD 3"								
EF5	EF5	DN 100, OD 4"								
9	Valve seat version (upper housing / lower housing) L0 Loose seat ring/Clamp connection									
10	Seal material in contact with the product 1 EPDM (FDA) 2 FKM (FDA) 3 HNBR (FDA)									
11	Surface quality of the housing 2 Inside Ra ≤ 0.8 µm, outside matte blasted									
12	Connection fittings N Welding end									
13	Accessories /T Housing connection T (up to DN 100, OD 4") /U Housing connection U /52 Adhesive ID tag									
+										
14–19	Air connection / Control and feedback system 00000M Metric for air hose Ø 6/4 mm 00000Z Inch for air hose Ø OD ¼" (6.35/4.35 mm) XXXXXX Order code for different control and feedback systems see section 9									

* Optionally with housing connection flange U or housing connection flange T (see position 13)

The code is composed as following, depending on the chosen configuration:

Position	1	2	3	4/5	6	7	8	9	10	11	12	13	14 to 19
Code	U		V	/	S			L0			N	/52	

For order codes differing from the standard version, please refer to section 7 (options).





Technical data of the standard version		
Recommended flow direction	Filling, emptying	
Material in contact with the product	1.4404/AISI 316 L	
Material not in contact with the product	1.4301/AISI 304	
Seal material in contact with the product	EPDM, FKM, HNBR	
Ambient temperature	0 to 45 °C	
Air supply pressure	6 bar (87 psi)	
Product pressure	5 bar (73 psi)	
Surface in contact with the product	DN, OD	Ra ≤ 0.8 µm
	IPS	Ra ≤ 1.2 µm
External housing surface	Matte blasted	
Control and feedback system	Connection 0 (without control top)	
Actuator type	Pneumatic actuator air/spring	
Connection fittings	Welding end	
Identification	Adhesive ID tag	
Valve seat version	Clamped seat ring	
Certificates		

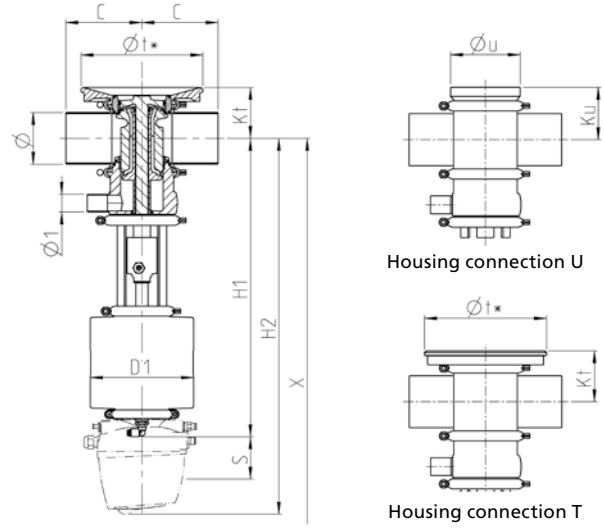

Nominal width	Pipe	Pipe leakage	Housing	Actuator	Dimensions			Housing connection U		Housing connection T		Valve	
	Ø [mm]	Ø1 [mm]	C [mm]	D1 [mm]	H1 [mm]	H2 [mm]	Extension X [mm]	Ku [mm]	Øu [mm]	Kt [mm]	Øt* [mm]	Stroke [mm]	Weight [kg]
DN 40	41.0 × 1.50	23 × 1.5	90	135	415	544	649	56.0	85 × 2.0	55.5	165	22	14
DN 50	53.0 × 1.50	23 × 1.5	90	135	421	550	655	62.0	85 × 2.0	61.5	165	30	15
DN 65	70.0 × 2.00	29 × 1.5	125	170	461	590	765	78.0	114 × 2.5	76.0	200	30	25
DN 80	85.0 × 2.00	29 × 1.5	125	170	488	617	792	85.5	114 × 2.5	83.5	200	40	26
DN 100	104.0 × 2.00	29 × 1.5	125	210	488	617	792	95.0	154 × 2.0	92.5	225	40	35
DN 125	129.0 × 2.00	41 × 1.5	150	261	652	781	1011	107.5	184 × 3.0	-	-	60	57
DN 150	154.0 × 2.00	41 × 1.5	150	261	676	805	1035	120.0	212 × 4.0	-	-	60	71
OD 1 ½"	38.1 × 1.65	23 × 1.5	90	135	416	545	650	54.5	85 × 2.0	54.0	165	22	14
OD 2"	50.8 × 1.65	23 × 1.5	90	135	422	551	656	60.8	85 × 2.0	60.3	165	31	15
OD 2 ½"	63.5 × 1.65	29 × 1.5	125	170	465	594	769	75.0	114 × 2.5	73.0	200	31	24
OD 3"	76.2 × 1.65	29 × 1.5	125	170	491	620	795	81.5	114 × 2.5	79.5	200	39	26
OD 4"	101.6 × 2.11	29 × 1.5	125	210	490	619	794	93.8	154 × 2.0	91.3	225	41	36
OD 6"	152.4 × 2.77	41 × 1.5	150	261	675	804	1034	118.5	212 × 4.0	-	-	60	71
IPS 2"	60.3 × 2.00	23 × 1.5	114.3	135	425	554	659	65.5	84 × 2.0	65.0	165	30	16
IPS 3"	88.9 × 2.30	29 × 1.5	152.5	170	490	619	794	87.5	114 × 2.5	85.5	200	40	28
IPS 4"	114.3 × 2.30	29 × 1.5	152.5	210	493	622	797	100.0	154 × 2.0	97.5	225	40	38
IPS 6"	168.2 × 2.70	41 × 1.5	152.5	261	670	799	1029	126.0	212 × 4.0	-	-	60	72

* The maximum wall thickness of the tank can be 8 mm.

Position	Description of the order code for the standard version																			
1	Valve type T VARIVENT® double-seat bottom valve, radial sealing																			
2	Housing combinations 																			
3	Supplement to the valve type R Upper radial seat																			
4/5	Nominal width (upper housing / lower housing) <table border="1"> <tr> <td>DN 40</td> <td>OD 1 ½"</td> <td rowspan="3">IPS 2"</td> </tr> <tr> <td>DN 50</td> <td>OD 2"</td> </tr> <tr> <td>DN 65</td> <td>OD 2 ½"</td> </tr> <tr> <td>DN 80</td> <td>OD 3"</td> <td>IPS 3"</td> </tr> <tr> <td>DN 100</td> <td>OD 4"</td> <td>IPS 4"</td> </tr> <tr> <td>DN 125</td> <td></td> <td></td> </tr> <tr> <td>DN 150</td> <td>OD 6"</td> <td>IPS 6"</td> </tr> </table>	DN 40	OD 1 ½"	IPS 2"	DN 50	OD 2"	DN 65	OD 2 ½"	DN 80	OD 3"	IPS 3"	DN 100	OD 4"	IPS 4"	DN 125			DN 150	OD 6"	IPS 6"
DN 40	OD 1 ½"	IPS 2"																		
DN 50	OD 2"																			
DN 65	OD 2 ½"																			
DN 80	OD 3"	IPS 3"																		
DN 100	OD 4"	IPS 4"																		
DN 125																				
DN 150	OD 6"	IPS 6"																		
6	Actuator type S Air/Spring																			
7	Non-actuated position Z Spring-to-close (NC)																			
8	Standard configuration with 6 bar air supply pressure for 5 bar product pressure (higher pressures on request) <table border="1"> <thead> <tr> <th>Actuator (spring-to-close)</th> <th>For nominal widths</th> </tr> </thead> <tbody> <tr> <td>CD</td> <td>DN 40, DN 50, OD 1 ½", OD 2", IPS 2"</td> </tr> <tr> <td>DF</td> <td>DN 65, OD 2 ½"</td> </tr> <tr> <td>DF5</td> <td>DN 80, OD 3", IPS 3"</td> </tr> <tr> <td>EG5</td> <td>DN 100, OD 4", IPS 4"</td> </tr> <tr> <td>SH6</td> <td>DN 125</td> </tr> <tr> <td>SK6</td> <td>DN 150, OD 6", IPS 6"</td> </tr> </tbody> </table>	Actuator (spring-to-close)	For nominal widths	CD	DN 40, DN 50, OD 1 ½", OD 2", IPS 2"	DF	DN 65, OD 2 ½"	DF5	DN 80, OD 3", IPS 3"	EG5	DN 100, OD 4", IPS 4"	SH6	DN 125	SK6	DN 150, OD 6", IPS 6"					
Actuator (spring-to-close)	For nominal widths																			
CD	DN 40, DN 50, OD 1 ½", OD 2", IPS 2"																			
DF	DN 65, OD 2 ½"																			
DF5	DN 80, OD 3", IPS 3"																			
EG5	DN 100, OD 4", IPS 4"																			
SH6	DN 125																			
SK6	DN 150, OD 6", IPS 6"																			
9	Valve seat version (upper housing / lower housing) L0 Loose seat ring/Clamp connection																			
10	Seal material in contact with the product <table border="1"> <tr> <td>1</td> <td>EPDM (FDA)</td> </tr> <tr> <td>2</td> <td>FKM (FDA)</td> </tr> <tr> <td>3</td> <td>HNBR (FDA); (up to DN 100, OD 4", IPS OD 4")</td> </tr> </table>	1	EPDM (FDA)	2	FKM (FDA)	3	HNBR (FDA); (up to DN 100, OD 4", IPS OD 4")													
1	EPDM (FDA)																			
2	FKM (FDA)																			
3	HNBR (FDA); (up to DN 100, OD 4", IPS OD 4")																			
11	Surface quality of the housing <table border="1"> <tr> <td>1</td> <td>Inside Ra ≤ 1.2 µm, outside matte blasted (IPS)</td> </tr> <tr> <td>2</td> <td>Inside Ra ≤ 0.8 µm, outside matte blasted (DN, OD)</td> </tr> </table>	1	Inside Ra ≤ 1.2 µm, outside matte blasted (IPS)	2	Inside Ra ≤ 0.8 µm, outside matte blasted (DN, OD)															
1	Inside Ra ≤ 1.2 µm, outside matte blasted (IPS)																			
2	Inside Ra ≤ 0.8 µm, outside matte blasted (DN, OD)																			
12	Connection fittings N Welding end NOTE: The leakage housing socket can be ordered with a GK connection fitting upon request (please specify separately when ordering).																			
13	Accessories /52 Adhesive ID tag																			
+																				
14-19	Air connection / Control and feedback system <table border="1"> <tr> <td>00000M</td> <td>Metric for air hose Ø 6/4 mm</td> </tr> <tr> <td>00000Z</td> <td>Inch for air hose Ø OD ¼" (6.35/4.35 mm)</td> </tr> <tr> <td>XXXXX</td> <td>Order code for different control and feedback systems see section 9</td> </tr> </table>	00000M	Metric for air hose Ø 6/4 mm	00000Z	Inch for air hose Ø OD ¼" (6.35/4.35 mm)	XXXXX	Order code for different control and feedback systems see section 9													
00000M	Metric for air hose Ø 6/4 mm																			
00000Z	Inch for air hose Ø OD ¼" (6.35/4.35 mm)																			
XXXXX	Order code for different control and feedback systems see section 9																			

The code is composed as following, depending on the chosen configuration:

Position	1	2	3	4/5	6	7	8	9	10	11	12	13	14 to 19
Code	T		R	/	S	Z		L0	1	2	N	/52	

For order codes differing from the standard version, please refer to section 7 (options).





Technical data of the standard version		
Recommended flow direction	Filling, emptying	
Material in contact with the product	1.4404/AISI 316 L	
Material not in contact with the product	1.4301/AISI 304	
Seal material in contact with the product	EPDM, FKM, HNBR	
Ambient temperature	0 to 45 °C	
Air supply pressure	6 bar (87 psi)	
Product pressure	5 bar (73 psi)	
Surface in contact with the product	DN, OD	Ra ≤ 0.8 µm
	IPS	Ra ≤ 1.2 µm
External housing surface	Matte blasted	
Control and feedback system	Connection 0 (without control top)	
Actuator type	Pneumatic actuator air/spring	
Connection fittings	Welding end	
Identification	Adhesive ID tag	
Valve seat version	Clamped seat ring	
Certificates		

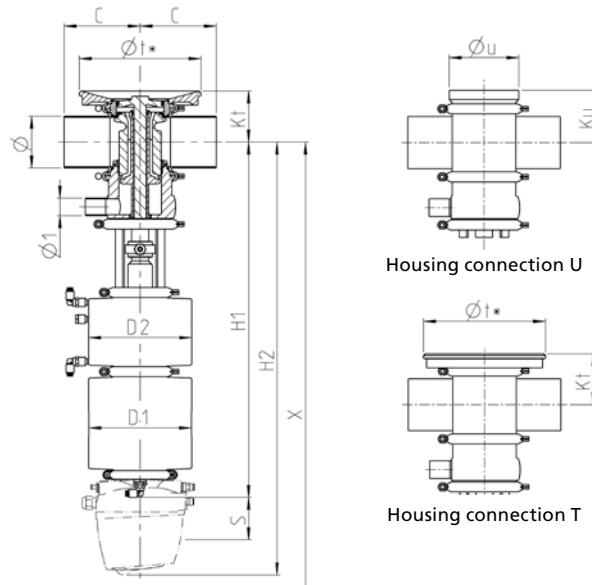

Nominal width	Pipe	Pipe leakage	Housing	Actuator		Dimensions			Housing connection U		Housing connection T		Valve	
	Ø [mm]	Ø1 [mm]	C [mm]	D1 [mm]	D2 [mm]	H1 [mm]	H2 [mm]	Extension X [mm]	Ku [mm]	Øu [mm]	Kt [mm]	Øt* [mm]	Stroke [mm]	Weight [kg]
DN 40	41.0 × 1.50	23 × 1.5	90	110	110	506	635	740	56.0	85 × 2.0	55.5	165	22	17
DN 50	53.0 × 1.50	23 × 1.5	90	110	110	504	633	738	62.0	85 × 2.0	61.5	165	30	17
DN 65	70.0 × 2.00	29 × 1.5	125	135	135	514	643	818	78.0	114 × 2.5	76.0	200	30	26
DN 80	85.0 × 2.00	29 × 1.5	125	170	170	581	710	885	85.5	114 × 2.5	83.5	200	40	34
DN 100	104.0 × 2.00	29 × 1.5	125	170	170	481	610	785	95.0	154 × 2.0	92.5	225	40	40
DN 125	129.0 × 2.00	41 × 1.5	150	210	210	760	889	1119	107.5	184 × 3.0	-	-	60	65
DN 150	154.0 × 2.00	41 × 1.5	150	210	210	784	913	1143	120.0	212 × 4.0	-	-	60	83
OD 1 ½"	38.1 × 1.65	23 × 1.5	90	110	110	507	636	741	54.5	85 × 2.0	54.0	165	22	17
OD 2"	50.8 × 1.65	23 × 1.5	90	110	110	505	634	739	60.8	85 × 2.0	60.3	165	31	17
OD 2 ½"	63.5 × 1.65	29 × 1.5	125	135	135	517	646	821	75.0	114 × 2.5	73.0	200	31	26
OD 3"	76.2 × 1.65	29 × 1.5	125	170	170	585	714	889	81.5	114 × 2.5	79.5	200	39	33
OD 4"	101.6 × 2.11	29 × 1.5	125	170	170	582	711	886	93.8	154 × 2.0	91.3	225	41	40
OD 6"	152.4 × 2.77	41 × 1.5	150	210	210	786	915	1145	118.5	212 × 4.0	-	-	60	79
IPS 2"	60.3 × 2.00	23 × 1.5	114.3	110	110	507	636	741	65.5	84 × 2.0	65.0	165	30	19
IPS 3"	88.9 × 2.30	29 × 1.5	152.5	170	170	583	712	887	87.5	114 × 2.5	85.5	200	40	36
IPS 4"	114.3 × 2.30	29 × 1.5	152.5	170	170	586	715	890	100.0	154 × 2.0	97.5	225	40	43
IPS 6"	168.2 × 2.70	41 × 1.5	152.5	210	210	778	907	1137	126.0	212 × 4.0	-	-	60	80

* The maximum wall thickness of the tank can be 8 mm.

Position	Description of the order code for the standard version																					
1	Valve type T VARIVENT® double-seat bottom valve with lift function, radial sealing																					
2	Housing combinations 																					
3	Supplement to the valve type RL Upper radial seat, with lifting actuator and spray cleaning RC Upper radial seat, with lifting actuator without spray cleaning																					
4/5	Nominal width (upper housing / lower housing) <table border="1"> <tr> <td>DN 40</td> <td>OD 1 ½"</td> <td rowspan="2">IPS 2"</td> </tr> <tr> <td>DN 50</td> <td>OD 2"</td> </tr> <tr> <td>DN 65</td> <td>OD 2 ½"</td> <td rowspan="2">IPS 3"</td> </tr> <tr> <td>DN 80</td> <td>OD 3"</td> </tr> <tr> <td>DN 100</td> <td>OD 4"</td> <td rowspan="2">IPS 4"</td> </tr> <tr> <td>DN 125</td> <td></td> </tr> <tr> <td>DN 150</td> <td>OD 6"</td> <td>IPS 6"</td> </tr> </table>	DN 40	OD 1 ½"	IPS 2"	DN 50	OD 2"	DN 65	OD 2 ½"	IPS 3"	DN 80	OD 3"	DN 100	OD 4"	IPS 4"	DN 125		DN 150	OD 6"	IPS 6"			
DN 40	OD 1 ½"	IPS 2"																				
DN 50	OD 2"																					
DN 65	OD 2 ½"	IPS 3"																				
DN 80	OD 3"																					
DN 100	OD 4"	IPS 4"																				
DN 125																						
DN 150	OD 6"	IPS 6"																				
6	Actuator type S Air/Spring																					
7	Non-actuated position Z Spring-to-close (NC)																					
8	Standard configuration with 6 bar air supply pressure for 5 bar product pressure (higher pressures on request) <table border="1"> <thead> <tr> <th>Actuator (spring-to-close)</th> <th>/ Lifting actuator</th> <th>For nominal widths</th> </tr> </thead> <tbody> <tr> <td>BD</td> <td>/BLR</td> <td>DN 40, DN 50, OD 1 ½", OD 2", IPS 2"</td> </tr> <tr> <td>CF</td> <td>/CLT</td> <td>DN 65, OD 2 ½"</td> </tr> <tr> <td>DF5</td> <td>/DLT5</td> <td>DN 80, OD 3", IPS 3"</td> </tr> <tr> <td>DG5</td> <td>/DLT5</td> <td>DN 100, OD 4", IPS 4"</td> </tr> <tr> <td>EH6</td> <td>/ELR6</td> <td>DN 125</td> </tr> <tr> <td>EK6</td> <td>/ELR6</td> <td>DN 150, OD 6", IPS 6"</td> </tr> </tbody> </table>	Actuator (spring-to-close)	/ Lifting actuator	For nominal widths	BD	/BLR	DN 40, DN 50, OD 1 ½", OD 2", IPS 2"	CF	/CLT	DN 65, OD 2 ½"	DF5	/DLT5	DN 80, OD 3", IPS 3"	DG5	/DLT5	DN 100, OD 4", IPS 4"	EH6	/ELR6	DN 125	EK6	/ELR6	DN 150, OD 6", IPS 6"
Actuator (spring-to-close)	/ Lifting actuator	For nominal widths																				
BD	/BLR	DN 40, DN 50, OD 1 ½", OD 2", IPS 2"																				
CF	/CLT	DN 65, OD 2 ½"																				
DF5	/DLT5	DN 80, OD 3", IPS 3"																				
DG5	/DLT5	DN 100, OD 4", IPS 4"																				
EH6	/ELR6	DN 125																				
EK6	/ELR6	DN 150, OD 6", IPS 6"																				
9	Valve seat version (upper housing / lower housing) L0 Loose seat ring/Clamp connection																					
10	Seal material in contact with the product 1 EPDM (FDA) 2 FKM (FDA) 3 HNBR (FDA); (up to DN 100, OD 4", IPS OD 4")																					
11	Surface quality of the housing 1 Inside Ra ≤ 1.2 µm, outside matte blasted (IPS) 2 Inside Ra ≤ 0.8 µm, outside matte blasted (DN, OD)																					
12	Connection fittings N Welding end NOTE: The leakage housing socket can be ordered with a GK connection fitting upon request (please specify separately when ordering).																					
13	Accessories /52 Adhesive ID tag																					
+																						
14–19	Air connection / Control and feedback system 00000M Metric for air hose Ø 6/4 mm 00000Z Inch for air hose Ø OD ¼" (6.35/4.35 mm) XXXXX Order code for different control and feedback systems see section 9																					

The code is composed as following, depending on the chosen configuration:

Position	1	2	3	4/5	6	7	8	9	10	11	12	13	14 to 19
Code	T			/	S	Z	/	L0			N	/52	+ [] [] [] [] [] [] [] [] [] []

For order codes differing from the standard version, please refer to section 7 (options).





Technical data of the standard version	
Recommended flow direction	Filling, emptying
Material in contact with the product	1.4404/AISI 316 L
Material not in contact with the product	1.4301/AISI 304
Seal material in contact with the product	EPDM, FKM, HNBR
Ambient temperature	0 to 45 °C
Air supply pressure	6 bar (87 psi)
Product pressure	5 bar (73 psi)
Surface in contact with the product	Ra ≤ 0.8 µm
External housing surface	Matte blasted
Control and feedback system	Connection 0 (without control top)
Actuator type	Pneumatic actuator air/spring
Connection fittings	Welding end
Identification	Adhesive ID tag
Valve seat version	Clamped seat ring
Certificates	

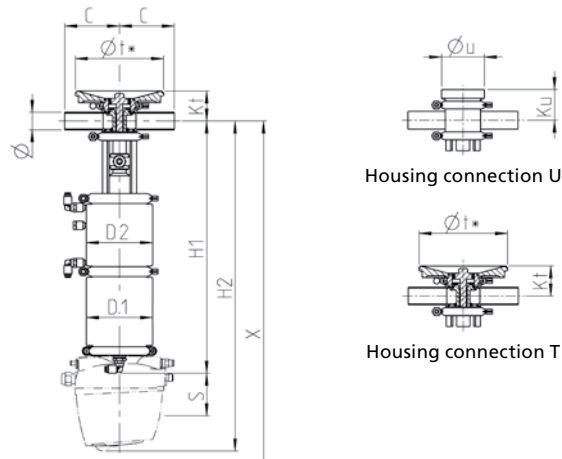

Nominal width	Pipe	Housing	Actuator		Dimensions			Housing connection U		Housing connection T		Valve	
	Ø [mm]	C [mm]	D1 [mm]	D2 [mm]	H1 [mm]	H2 [mm]	Extension X [mm]	Ku [mm]	Øu [mm]	Kt [mm]	Øt* [mm]	Stroke [mm]	Weight [kg]
DN 25	29.0 × 1.50	90	110	110	412	541	646	50	70 × 2	49	145	25	13
OD 1"	25.4 × 1.65	90	110	110	414	543	648	49	70 × 2	47	145	22	13

* The maximum wall thickness of the tank can be 8 mm.

Position	Description of the order code for the standard version
1	Valve type T VARIVENT® double-seat bottom valve with lift function, radial sealing
2	Housing combinations 
3	Supplement to the valve type RC Upper radial seat, with lifting actuator without spray cleaning
4/5	Nominal width (upper housing / lower housing) DN 25 OD 1"
6	Actuator type S Air/Spring
7	Non-actuated position Z Spring-to-close (NC)
8	Standard configuration with 6 bar air supply pressure for 5 bar product pressure (higher pressures on request) Actuator (spring-to-close) / Lifting actuator BD /BLR
9	Valve seat version (upper housing / lower housing) L0 Loose seat ring/Clamp connection
10	Seal material in contact with the product 1 EPDM (FDA) 2 FKM (FDA) 3 HNBR (FDA)
11	Surface quality of the housing 2 Inside Ra ≤ 0.8 µm, outside matte blasted
12	Connection fittings N Welding end NOTE: The leakage housing socket can be ordered with a GK connection fitting upon request (please specify separately when ordering).
13	Accessories /52 Adhesive ID tag
+	
14-19	Air connection / Control and feedback system 00000M Metric for air hose Ø 6/4 mm 00000Z Inch for air hose Ø OD ¼" (6.35/4.35 mm) XXXXX Order code for different control and feedback systems see section 9

The code is composed as following, depending on the chosen configuration:

Position	1	2	3	4/5	6	7	8	9	10	11	12	13	14 to 19
Code	T		RC	/	S	Z	BD/BLR	L0			N	/52	+ [] [] [] [] [] [] [] [] [] []

For order codes differing from the standard version, please refer to section 7 (options).



Supplement to the valve type

VARIVENT® lifting actuator	137
VARIVENT® control cone equal percentage	138
VARIVENT® control cone linear	139
VARIVENT® conversion kit bellows, stainless steel	140
VARIVENT® conversion kit bellows, PTFE	141
VARIVENT® conversion kit D-tec® for shut-off valves	142
VARIVENT® conversion kit D-tec® for divert valves	143

Housing and nominal widths

VARIVENT® jacketed valve housings	144
VARIVENT® housing with elevated pressure level	145
Mix-matched housing combinations	146
Vertical ports suitable for orbital welding	148
Tangential valve housings	148

Actuators

VARIVENT® actuator air/spring	150
ECOVENT® actuator air/spring for application with feedback system	151
ECOVENT® actuator air/spring for application without feedback system	152
VARIVENT® actuator air/spring, air-assisted	153
VARIVENT® booster cylinder for actuator air/spring	154
VARIVENT® actuator air/air	155
VARIVENT® manual actuator	156
ECOVENT® manual actuator	157

Seal materials

FFKM (FDA)	158
------------------	-----

Surface qualities

Inner and outer surface of the housings	159
Electropolishing	160

Connection fittings

Overview	161
VARIVENT® flange connection	162
Pipe fitting acc. to DIN 11851	163
Hygienic flange connection acc. to DIN 11853-2	164
Clamp connection (Tri-Clamp)	165

Accessories

VARIVENT® damping cylinder	166
VARIVENT® two-position-stop	167
VARIVENT® limit stop.....	168
VARIVENT® sterile lock for single-seat valves	169
VARIVENT® sterile lock for double-seat valves, complete	170
VARIVENT® sterile lock for double-seat valves (balancer flushing).....	171
VARIVENT® leakage connector.....	172
VARIVENT® leakage connector for balancer.....	173
VARIVENT® flushing valves.....	174

Additional options

VARIVENT® CIP connection for double-seat valves.....	176
Test report and inspection certificate.....	177
ID plates, TAG numbers.....	178
3-A symbol	179
Transport device.....	180
VARIVENT® manual emergency actuator	181

Actuator selection.....	182
-------------------------	-----



Typical application and description

In a double-seat valve, in order to clean the two valve discs, inclusive seal surfaces and the leakage chamber, by using seat lifting, an additional lifting actuator is installed to lift the main actuator and the lantern.

The lifting actuator is supplied with air via the two connections provided on the particular control and feedback system. Both valve discs can be activated separately using this lifting actuator.

The configuration and required size of lifting actuator is determined by GEA Tuchenhagen. When ordering, it is necessary to specify the prevailing product pressure, as well as the available air supply pressure, or to select an appropriate combination from one of the actuator selection sheets.

Available nominal widths		
Metric	DN	25–150
Inch OD	OD	1"–6"
Inch IPS	IPS	2"–6"

Available valve types	
Single-seat valves with shut-off function	–
Single-seat valves with divert function	–
Mixproof valves with shut-off function	–
Mixproof valves with shut-off function and seat lifting	D, B, R, L, M
Mixproof valves with divert function	Y
Tank bottom valves	T

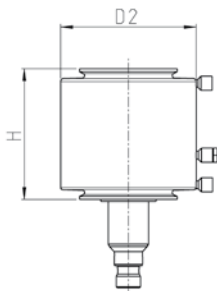

Technical data	
Material	1.4301
Outside surface	Turned, Ra ≤ 1.6 µm

Type	Dimensions			
	No. 8 in the order code	D2 [mm]	H [mm]	Weight [kg]
/BL_		110	120	4.6
/CL_		135	120	5.8
/DL_		170	120	8.0
/EL_		210	120	10.5
/CL_5		135	130	4.9
/DL_5		170	130	8.3
/EL_5		210	130	10.8
/EL_6		210	158	15.7
/SL_6		260	158	21.0

Incorporation of the option in the order code and example

Position	Description of the order code for options
3	Supplement to the valve type
	L With lifting actuator and spray cleaning
	C With lifting actuator without spray cleaning
8	Actuator (spring-to-close) /Lifting actuator
	.../... Required combination of main actuator / lifting actuator acc. to actuator selection sheet (e.g. EG/ELB)

Position	1	2	3	4/5	6	7	8	9	10	11	12	13	14 to 19
Code	D	E	L	- DN 80/DN 80 -	S	Z	- EG/ELB -	L0	1	2	N	/52	+ 0 0 0 0 0 M





Typical application and description

For targeted setting of a required flow e.g. for pressure reduction or flow limiting.

The VARIVENT® shut-off valve type N can be equipped with a control cone. A defined flow rate can be set in conjunction with a manual actuator. With a pneumatic actuator, it is possible to achieve an individually set rate, for example using a limit stop or a two-position stop (cylinder).

Alternatively, it is possible to equip the valve with the control and feedback system T.VIS® P-15 so that the valve can perform simple control tasks. Equal percentage control cones are used if less than 30% of the total pressure loss is caused in the line system of the control valve. When the valve is open, not only the full flow rate can be achieved but precision control can also be achieved when the valve is almost closed.

Valves with different Kvs values are available. Please contact GEA Tuchenhagen if necessary to ask about the necessary technical configuration and the available Kvs values for each nominal width.

Available nominal widths		
Metric	DN	25 – 150
Inch OD	OD	1" – 4"
Inch IPS	IPS	6"

Available valve types	
Single-seat valves with shut-off function	N
Single-seat valves with divert function	–
Mixproof valves with shut-off function	–
Mixproof valves with shut-off function and seat lifting	–
Mixproof valves with divert function	–
Tank bottom valves	N

Technical data	
Type	F
Material	1.4404
Control characteristics	Equal percentage

Incorporation of the option in the order code and example

Position	Description of the order code for options
3	Supplement to the valve type
	F Control cone equal percentage

Position	1	2	3	4/5	6	7	8	9	10	11	12	13	14 to 19	
Code	N	B	F	- DN 80/DN 80 -	S	Z	- RG -	L0	-	1	2	N	/52	+ 0 0 0 0 0 M



Typical application and description

For targeted setting of a required flow e.g. for pressure reduction or flow limiting.

The VARIVENT® shut-off valve type N can be equipped with a control cone. A defined flow rate can be set in conjunction with a manual actuator. With a pneumatic actuator, it is possible to achieve an individually set rate, for example using a limit stop or a two-position stop (cylinder).

Alternatively, it is possible to equip the valve with the control and feedback system T.VIS® P-15 so that the valve can perform simple control tasks. Equal percentage control cones are used if less than 30% of the total pressure loss is caused in the line system of the control valve.

Valves with different Kvs values are available. Please contact GEA Tuchenhagen if necessary to ask about the necessary technical configuration and the available Kvs values for each nominal width.

Available nominal widths		
Metric	DN	25–150
Inch OD	OD	1"–4"

Available valve types	
Single-seat valves with shut-off function	N
Single-seat valves with divert function	–
Mixproof valves with shut-off function	–
Mixproof valves with shut-off function and seat lifting	–
Mixproof valves with divert function	–
Tank bottom valves	N

Technical data	
Type	J
Material	1.4404
Control characteristics	Linear

Incorporation of the option in the order code and example

Position	Description of the order code for options
3	Supplement to the valve type J Control cone linear

Position	1	2	3	4/5	6	7	8	9	10	11	12	13	14 to 19	
Code	N	B	J	- DN 80/DN 80 -	S	Z	- RG -	LO	-	1	2	N	/52	+ 0 0 0 0 0 M



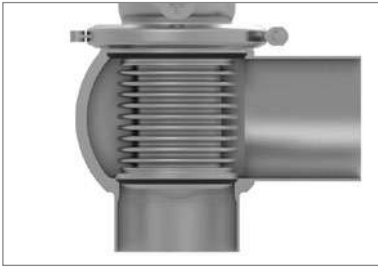

Typical application and description

Conversion of a VARIVENT® hygienic valve type N into a sterile version within existing systems.

For more sensitive applications, single-seat valves in existing systems can be modified by using bellows, e.g. for use in highly hygienic applications. Not only the bellows but also a lantern, adapter and securing clip are supplied for the conversion.

Please contact GEA Aseptomag AG if you are planning new aseptic applications!

Available nominal widths		
Metric	DN	25 – 100
Inch OD	OD	1" – 4"

Available valve types	
Single-seat valves with shut-off function	N
Single-seat valves with divert function	–
Mixproof valves with shut-off function	–
Mixproof valves with shut-off function and seat lifting	–
Mixproof valves with divert function	–
Tank bottom valves	N

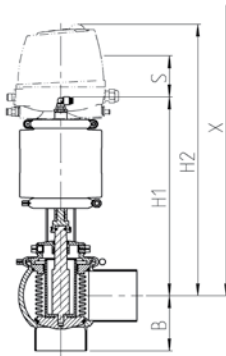

Technical data of the standard version	
Recommended flow direction	From bottom to top
Material in contact with the product	1.4404/AISI 316 L
Material not in contact with the product	1.4301/AISI 304
Seal material in contact with the product	EPDM (FDA)
Air supply pressure	Max. 6 bar (max. 87 psi)
Product pressure	Max. 6 bar (max. 87 psi)
Certificates	

Order numbers of conversion kit:

Nominal width	Housing B [mm]	Dimensions			Valve		Article number	
		H1 [mm]	H2 [mm]	X [mm]	Stroke S [mm]	Weight [kg]	Material EPDM FKM	
DN 25	58	248	377	462	5.2	7	221-004755	221-004765
DN 40	64	289	418	503	7.0	10	221-004757	221-004767
DN 50	70	295	424	509	7.3	15	221-004758	221-004768
DN 65	83	309	438	583	10.1	14	221-004760	221-004770
DN 80	91	317	446	591	15.0	15	221-004762	221-004772
DN 100	100	358	487	632	21.2	22	221-004764	221-004774
OD 1"	56.00	246	375	375	3.2	7	221-004756	221-004766
OD 1 1/2"	62.50	288	417	417	5.5	10	221-004757	221-004767
OD 2"	68.75	294	423	423	10.0	14	221-004758	221-004768
OD 2 1/2"	80.00	294	423	423	14.4	14	221-004760	221-004770
OD 3"	86.50	313	442	442	19.1	14	221-004763	221-004773
OD 4"	98.75	357	486	486	27.5	22	221-004764	221-004774

Order as a complete valve by incorporating the option in the order code and example

Position	Description of the order code for options
3	Supplement to the valve type A/S Bellows stainless steel

Position	1	2	3	4/5	6	7	8	9	10	11	12	13	14 to 19						
Code	N	L	A/S	- DN 80/DN 80 -	S	Z	- RG -	L0	-	1	5	N	/52	+	0	0	0	0	M

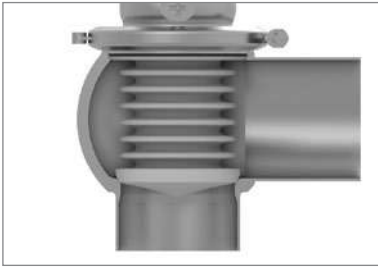

Typical application and description

Conversion of a VARIVENT® hygienic valve type N into a sterile version within existing systems.

For more sensitive applications, single-seat valves in existing systems can be modified by using a bellows, e.g. for use in highly hygienic applications. Not only the bellows but also a lantern, adapter and securing clip are supplied for the conversion.

Please contact GEA Aseptomag AG if you are planning new aseptic applications!

Available nominal widths		
Metric	DN	25 – 100
Inch OD	OD	1" – 4"

Available valve types	
Single-seat valves with shut-off function	N
Single-seat valves with divert function	–
Mixproof valves with shut-off function	–
Mixproof valves with shut-off function and seat lifting	–
Mixproof valves with divert function	–
Tank bottom valves	N

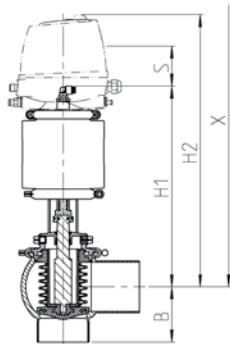

Technical data of the standard version	
Recommended flow direction	From bottom to top
Material in contact with the product	1.4404/AISI 316 L Bellows PTFE (FDA)
Material not in contact with the product	1.4301/AISI 304
Seal material in contact with the product	PTFE (FDA)
Air supply pressure	Max. 6 bar (max. 87 psi)
Product pressure	Max. 6 bar (max. 87 psi)
Certificates	

Order numbers of conversion kit:

Nominal width	Housing B [mm]	Dimensions			Valve		Article number
		H1 [mm]	H2 [mm]	X [mm]	Stroke S [mm]	Weight [kg]	Material PTFE
DN 25	58	248	377	462	6.4	7	221-004775
DN 40	64	289	418	503	11.2	9	221-004777
DN 50	70	295	424	509	14.8	10	221-004778
DN 65	83	309	438	583	19.3	14	221-004779
DN 80	91	317	446	591	19.8	14	221-004780
DN 100	100	358	487	632	21.2	20	221-004782
OD 1"	56.00	246	375	460	3.2	7	221-004776
OD 1 1/2"	62.50	288	417	502	5.5	9	221-004777
OD 2"	68.75	294	423	508	10.0	10	221-004778
OD 2 1/2"	80.00	306	435	580	14.4	14	221-004779
OD 3"	86.50	313	442	587	19.1	14	221-004781
OD 4"	98.75	357	486	631	27.5	21	221-004782

Order as a complete valve by incorporating the option in the order code and example

Position	Description of the order code for options									
3	Supplement to the valve type									
	A/P Bellows PTFE									

Position	1	2	3	4/5		6	7	8	9	10	11	12	13	14 to 19										
Code	N	L	A/P	-	DN 80/DN 80	-	S	Z	-	RG	-	L0	-	1	5	N	/52	+	0	0	0	0	0	M





Typical application and description

From Hygienic to UltraClean – D-tec® conversion kit for VARIVENT®

The D-tec® conversion kit makes it possible to convert existing systems from a hygienic stem diaphragm sealing to the D-tec® diaphragm for achieving UltraClean production conditions. Using components that prevent exchange with the exterior atmosphere simplifies the production of demanding and sensitive products and advances product shelf life.

D-tec® valves are used especially in the food, beverages, biotech and dairy industries.

Please contact GEA Aseptomag AG if you are planning new aseptic applications!

Available nominal widths		
Metric	DN	25 – 100
Inch OD	OD	1" – 4"

Available valve types	
Single-seat valves with shut-off function	N
Single-seat valves with divert function	–
Mixproof valves with shut-off function	–
Mixproof valves with shut-off function and seat lifting	–
Mixproof valves with divert function	–
Tank bottom valves	N

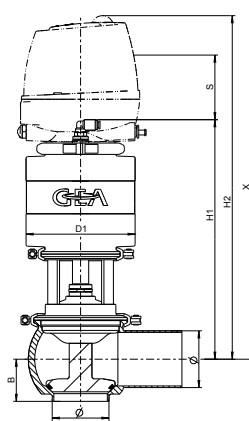

Technical data of the standard version		
Recommended flow direction	From bottom to top	
Material	Housing	1.4404 / AISI 316L
	Diaphragm	D-tec®
	Valve seat seal	EPDM, FKM, HNBR
	Housing seal	EPDM, FKM, HNBR
	Not in contact with product 1.4301/AISI 304	
Operating temperature	Max. 135 °C (275 °F)	
Sterilization temperature	Max. 150 °C (302 °F) for 30 min	
Air supply pressure	6 bar (87 psi)	
Product pressure	5 bar (73 psi)	

Order numbers conversion kit + seal kit

Nominal width	Housing	Dimensions			Valve	Article number*			
	B [mm]	H1 [mm]	H2 [mm]	X [mm]	Stroke S [mm]	conversion kit	Seal kit (material)		
							EPDM	FKM	HNBR
DN 25	31	248	412	493	10	221-743.01	221-741.01	221-741.05	221-741.09
DN 40	39	293	457	558	17	221-743.02	221-741.02	221-741.06	221-741.10
DN 50	41	299	463	578	17	221-743.03	221-741.02	221-741.06	221-741.10
DN 65	52	307	471	619	25	221-743.04	221-741.03	221-741.07	221-741.11
DN 80	60	314	478	649	25	221-743.05	221-741.03	221-741.07	221-741.11
DN 100	70	358	522	722	30	221-743.06	221-741.04	221-741.08	221-741.12
OD 1"	29	246	410	485	10	221-743.07	221-741.01	221-741.05	221-741.09
OD 1 ½"	39	291	455	553	17	221-743.08	221-741.02	221-741.06	221-741.10
OD 2"	42	297	461	575	17	221-743.09	221-741.02	221-741.06	221-741.10
OD 2 ½"	54	304	468	612	25	221-743.10	221-741.03	221-741.07	221-741.11
OD 3"	54	310	474	631	25	221-743.11	221-741.03	221-741.07	221-741.11
OD 4"	69	357	521	718	30	221-743.12	221-741.04	221-741.08	221-741.12

* For every conversion kit a suitable seal kit must be included in the order.

D-tec® is a trade mark of GEA Aseptomag registered in Switzerland.



Typical application and description

From Hygienic to UltraClean – D-tec® conversion kit for VARIVENT®

The D-tec® conversion kit makes it possible to convert existing systems from a hygienic stem diaphragm sealing to the D-tec® diaphragm for achieving UltraClean production conditions. Using components that prevent exchange with the exterior atmosphere simplifies the production of demanding and sensitive products and advances product shelf life.

D-tec® valves are used especially in the food, beverages, biotech and dairy industries.

Please contact GEA Aseptomag AG if you are planning new aseptic applications!

Available nominal widths		
Metric	DN	25–100
Inch OD	OD	1"–4"

Available valve types	
Single-seat valves with shut-off function	–
Single-seat valves with divert function	W
Mixproof valves with shut-off function	–
Mixproof valves with shut-off function and seat lifting	–
Mixproof valves with divert function	–
Tank bottom valves	–

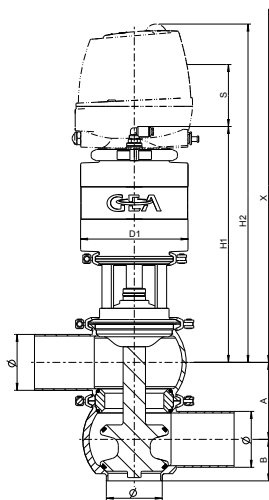

Technical data of the standard version		
Recommended flow direction	product-merging	
Material	Housing	1.4404 /AISI 316L
	Diaphragm	D-tec®
	Valve seat seal	EPDM, FKM, HNBR
	Housing seal	EPDM, FKM, HNBR
	Not in contact with product 1.4301/AISI 304	
Operating temperature	Max. 135 °C (275 °F)	
Sterilization temperature	Max. 150 °C (302 °F) for 30 min	
Air supply pressure	6 bar (87 psi)	
Product pressure	5 bar (73 psi)	

Order numbers conversion kit + seal kit

Nominal width	Housing		Dimensions			Valve	conversion kit	Article number*		
	B [mm]	A [mm]	H1 [mm]	H2 [mm]	X [mm]	Stroke S [mm]		Seal kit (material)		
								EPDM	FKM	HNBR
DN 25	31	50.0	248	412	593	8	221-744.01	221-742.01	221-742.05	221-742.09
DN 40	39	62.0	293	457	682	14	221-744.02	221-742.02	221-742.06	221-742.10
DN 50	41	74.0	299	463	726	14	221-744.03	221-742.02	221-742.06	221-742.10
DN 65	52	96.0	337	501	841	22	221-744.04	221-742.03	221-742.07	221-742.11
DN 80	60	111.0	344	508	901	22	221-744.05	221-742.03	221-742.07	221-742.11
DN 100	70	130.0	358	522	982	25	221-744.06	221-742.04	221-742.08	221-742.12
OD 1"	29	46.0	246	410	577	8	221-744.07	221-742.01	221-742.05	221-742.09
OD 1 ½"	39	59.0	291	455	671	14	221-744.08	221-742.02	221-742.06	221-742.10
OD 2"	42	71.5	297	461	718	14	221-744.09	221-742.02	221-742.06	221-742.10
OD 2 ½"	54	90.0	334	498	822	22	221-744.10	221-742.03	221-742.07	221-742.11
OD 3"	54	103.0	340	504	867	22	221-744.11	221-742.03	221-742.07	221-742.11
OD 4"	69	127.5	357	521	973	25	221-744.12	221-742.04	221-742.08	221-742.12

* For every conversion kit a suitable seal kit must be included in the order.

D-tec® is a trade mark of GEA Aseptomag registered in Switzerland.





Typical application and description

For keeping chocolate or margarine fluid and for cooling ice cream.

For heating or cooling products, a hot or cold medium is passed through the housing jacket in the opposite flow direction.

The product range includes jacketed valve housings with both one and two vertical ports. However, the housings cannot be supplied for valves with mix-matched nominal widths or a welded seat ring.

Available nominal widths		
Metric	DN	25 – 100
Inch OD	OD	1" – 4"

Available valve types	
Single-seat valves with shut-off function	N, U, N/ECO
Single-seat valves with divert function	W, X, W/ECO
Mixproof valves with shut-off function	D, B, R, K
Mixproof valves with shut-off function and seat lifting	D, B, R
Mixproof valves with divert function	Y
Tank bottom valves	N, U, T

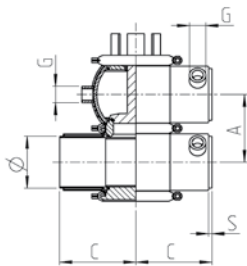

Technical data	
Material	1.4404/AISI 316 L
Max. product pressure	10 bar DN 25–50, OD 1"–2" 6 bar DN 65–100, OD 2 ½"–4"
Jacket pressure resistance	3.5 bar
Surface in contact with the product	Ra ≤ 0.8 µm
Outside surface	Matte blasted
Valve seat version	Clamped connection

Nominal width	Dimensions						Weight [kg] single vertical ports	Weight [kg] double vertical ports
	Ø [mm]	C [mm]	A [mm]	S [mm]	G [mm]			
DN 25	29 × 1.5	90	50	5	1/4"	0.5	0.7	
DN 40	41 × 1.5	90	62	5	1/4"	0.8	1.1	
DN 50	53 × 1.5	90	74	5	1/4"	1.0	1.1	
DN 65	70 × 2.0	125	96	5	1/2"	2.5	2.7	
DN 80	85 × 2.0	125	111	5	1/2"	3.0	3.2	
DN 100	104 × 2.0	125	130	5	1/2"	4.1	4.4	
OD 1"	25.4 × 1.65	90	46.0	5	1/4"	0.5	0.6	
OD 1 ½"	38.1 × 1.65	90	59.0	5	1/4"	0.8	0.9	
OD 2"	50.8 × 1.65	90	71.5	5	1/4"	1.0	1.1	
OD 2 ½"	63.5 × 1.65	125	90.0	5	1/2"	2.3	2.5	
OD 3"	76.2 × 1.65	125	103.0	5	1/2"	2.7	2.8	
OD 4"	101.6 × 2.11	125	127.5	5	1/2"	4.1	4.0	

Incorporation of the option in the order code and example

Position	Description of the order code for options
13	Accessories
	/25 Jacketed valve housings

Position	1	2	3	4/5	6	7	8	9	10	11	12	13	14 to 19	
Code	D	E		- DN 80/DN 80 -	S	Z	- CD -	L0	-	1	2	N	/25 /52	+ 0 0 0 0 0 M

Typical application and description

For static use of valves with increased product pressure.

For increasing the strength, the half rings on the valve housings are made of cast material and the housings with nominal widths DN 100/OD 4" are made of a higher-quality material.

IMPORTANT: The differential pressure between the product chambers on both sides of the valve disc is not allowed to exceed 10 bar during switching of the valve. The actuator size of the valve must be selected based on the product data.

Available nominal widths		
Metric	DN	25 – 100
Inch OD	OD	1" – 4"

Available valve types	
Single-seat valves with shut-off function	N, U, N/ECO
Single-seat valves with divert function	W, X, W/ECO
Mixproof valves with shut-off function	D, B, R, K
Mixproof valves with shut-off function and seat lifting	D, B, R, K
Mixproof valves with divert function	Y
Tank bottom valves	–

Technical data		
Material	1.4404/AISI 316 L 1.4462	DN 25–80, OD 1"–3" DN 100, OD 4"
Pressure level	PS 20 bar	TS 0/+150 °C
Pressure level jacketed housing	PS 16 bar	DN 25–80, OD 1"–3"; TS 0/+150 °C
Valve seat version	Clamped or welded* housing connection	

* not for jacketed housings

Nominal width	Dimensions		
	Ø [mm]	C [mm]	A [mm]
DN 25	29 × 1.5	90	50
DN 40	41 × 1.5	90	62
DN 50	53 × 1.5	90	74
DN 65	70 × 2.0	125	96
DN 80	85 × 2.0	125	111
DN 100	104 × 2.0	125	130
OD 1"	25.4 × 1.65	90	46.0
OD 1 ½"	38.1 × 1.65	90	59.0
OD 2"	50.8 × 1.65	90	71.5
OD 2 ½"	63.5 × 1.65	125	90.0
OD 3"	76.2 × 1.65	125	103.0
OD 4"	101.6 × 2.11	125	127.5

Incorporation of the option in the order code and example

Position	Description of the order code for options
13	Accessories
	/37 PS 20 bar
	/38 PS 16 bar (jacketed valve housing)

Position	1	2	3	4/5	6	7	8	9	10	11	12	13	14 to 19	
Code	N	E		- DN 80/DN 80 -	S	Z	- CD -	L0	-	1	2	N	/37 /52 +	0 0 0 0 0 M



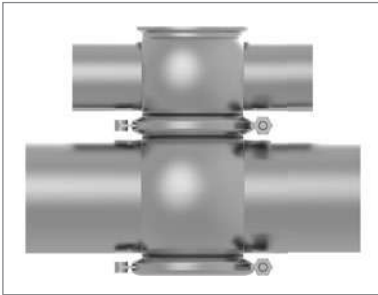

Typical application and description

Many mix-matched housings are already available.

For technical reasons, however, a mix-matched combination is not possible for all valve types! If required, please contact GEA Tuchenhagen to ask about the feasibility.

The first mentioned nominal width indicates the upper valve housing, the second one is the nominal width of the lower valve housing. In divert valves, both upper housings are configured with the same nominal width. The larger housing in the mix-matched combination must always be configured as a housing with two vertical ports.

Available nominal widths		
Metric	DN	25 – 150
Inch OD	OD	1" – 6"
Inch IPS	IPS	2" – 6"

Available valve types	
Single-seat valves with shut-off function	N, U, N/ECO
Single-seat valves with divert function	W, X, W/ECO
Mixproof valves with shut-off function	D, B, R, K
Mixproof valves with shut-off function and seat lifting	D, B, R, K
Mixproof valves with divert function	–
Tank bottom valves	–

lower housing \ upper housing	DN 25			DN 40			DN 50			DN 65		
	A	C1	C2	A	C1	C2	A	C1	C2	A	C1	C2
DN 25	50	90	90	56	90	90	62	90	90	70	125	90
DN 40	56	90	90	62	90	90	68	90	90	76	125	90
DN 50	62	90	90	68	90	90	74	90	90	82	125	90
DN 65	70	90	125	76	90	125	82	90	125	96	125	125
DN 80	77.5	90	125	83.5	90	125	89.5	90	125	103.5	125	125
DN 100	87	90	125	93	90	125	99	90	125	113	125	125
DN 125	–	–	–	105.5	90	125	111.5	90	125	125.5	125	125
DN 150	–	–	–	118	90	150	124	90	150	138	125	150

lower housing \ upper housing	OD 1"			OD 1 ½"			OD 2"			OD 2 ½"		
	A	C1	C2	A	C1	C2	A	C1	C2	A	C1	C2
OD 1"	46	90	90	52.5	90	90	58.75	90	90	65	125	90
OD 1 ½"	52.5	90	90	59	90	90	65.25	90	90	71.5	125	90
OD 2"	58.75	90	90	65.25	90	90	71.5	90	90	77.75	125	90
OD 2 ½"	65	90	125	71.5	90	125	77.75	90	125	90	125	125
OD 3"	71.5	90	125	78	90	125	84.25	90	125	96.5	125	125
OD 4"	83.75	90	125	90.25	90	125	96.5	90	125	108.75	125	125
OD 6"	–	–	–	116.5	90	150	122.75	90	150	133.5	125	150

lower housing \ upper housing	IPS 2"		
	A	C1	C2
IPS 2"	58.75	90	90
IPS 3"	65.25	90	90
IPS 4"	71.5	90	90
IPS 6"	77.75	90	125

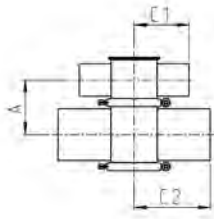

Technical data	
Material	1.4404/AISI 316 L
Product pressure	10 bar
Valve seat version	Clamped or welded housing connection

DN 80			DN 100			DN 125			DN 150			upper housing / lower housing
A	C1	C2	A	C1	C2	A	C1	C2	A	C1	C2	
77.5	125	90	87	125	90	-	-	-	-	-	-	DN 25
83.5	125	90	93	125	90	105.5	125	90	118	150	90	DN 40
89.5	125	90	99	125	90	111.5	125	90	124	150	90	DN 50
103.5	125	125	113	125	125	125.5	125	125	138	150	125	DN 65
111	125	125	120.5	125	125	133	125	125	145.5	150	125	DN 80
120.5	125	125	130	125	125	142.5	125	125	155	150	125	DN 100
133	125	125	142.5	125	125	155	125	125	167.5	150	125	DN 125
145.5	125	150	155	125	150	167.5	125	150	180	150	150	DN 150

OD 3"			OD 4"			OD 6"			upper housing / lower housing
A	C1	C2	A	C1	C2	A	C1	C2	
71.5	125	90	83.75	125	90	-	-	-	OD 1"
78	125	90	90.25	125	90	116.5	150	90	OD 1 1/2"
84.25	125	90	102.5	125	90	122.75	150	90	OD 2"
96.5	125	125	115.25	125	125	133.5	150	125	OD 2 1/2"
103	125	125	115.25	125	125	140	150	125	OD 3"
115.25	125	125	127.5	125	125	152.25	150	125	OD 4"
140	125	150	152.25	125	150	177	150	150	OD 6"

IPS 3"			IPS 4"			IPS 6"			upper housing / lower housing
A	C1	C2	A	C1	C2	A	C1	C2	
95	152.5	114.5	107.5	152.5	114.5	133.5	152.5	114.5	IPS 2"
115	152.5	152.5	121.5	152.5	152.5	153.5	152.5	152.5	IPS 3"
127.5	152.5	152.5	140	152.5	152.5	166	152.5	152.5	IPS 4"
153.5	152.5	152.5	166	152.5	152.5	192	152.5	152.5	IPS 6"

Incorporation of the option in the order code and example

Position	Description of the order code for options
4/5	Nominal width (upper housing / lower housing)

Position	1	2	3	4/5	6	7	8	9	10	11	12	13	14 to 19					
Code	N	E		OD 2" / OD 3"	S	Z	CD	LO	1	2	N	/52	0	0	0	0	0	M





Typical application and description

The orbital welding process is used in pipeline construction when high weld qualities have to be achieved under controllable conditions.

The extended vertical port (dimension B) makes it possible to weld in the housing using welding tongs or an orbital welding head.

Available nominal widths		
Metric	DN	25 – 150
Inch OD	OD	1" – 6"
Inch IPS	IPS	2" – 6"

Available valve types	
Single-seat valves with shut-off function	N, N/ECO
Single-seat valves with divert function	W, W/ECO
Mixproof valves with shut-off function	–
Mixproof valves with shut-off function and seat lifting	–
Mixproof valves with divert function	–
Tank bottom valves	N, N/ECO

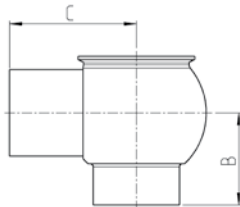

Technical data	
Material	1.4404/AISI 316 L
Product pressure	10 bar

Nominal width	Dimensions			
	Ø [mm]	A [mm]	B [mm]	C [mm]
DN 25	29 × 1.5	50.0	58.0	90
DN 40	41 × 1.5	62.0	64.0	90
DN 50	53 × 1.5	74.0	70.0	90
DN 65	70 × 2.0	96.0	83.0	125
DN 80	85 × 2.0	111.0	90.5	125
DN 100	104 × 2.0	130.0	100.0	125
DN 125	129 × 2.0	155.0	112.5	150
DN 150	154 × 2.0	180.0	125.0	150
OD 1"	25.4 × 1.65	46.0	56.0	90
OD 1 ½"	38.1 × 1.65	59.0	62.5	90
OD 2"	50.8 × 1.65	71.5	68.8	90
OD 2 ½"	63.5 × 1.65	90.0	80.0	125
OD 3"	76.2 × 1.65	103.0	86.5	125
OD 4"	101.6 × 2.11	127.5	98.8	125
OD 6"	152.4 × 2.77	177.0	123.5	150
IPS 2"	60.3 × 2.0	81.0	73.5	114.3
IPS 3"	88.9 × 2.3	115.0	92.5	152.5
IPS 4"	114.3 × 2.3	140.0	105.0	152.5
IPS 6"	168.2 × 2.7	192.0	131.0	152.5

Incorporation of the option in the order code and example

Position	Description of the order code for options
13	Accessories
/28	Lower housing port suitable for orbital welding

Position	1	2	3	4/5	6	7	8	9	10	11	12	13	14 to 19
Code	N	T		DN 80/DN 80	S	Z	CD	V0	1	2	N	/28 /52	0 0 0 0 0 M



Typical application and description

Horizontal tank valves or horizontally installed valves are configured so the connection piping can be completely drained.

Tangential valve housings are provided with eccentrically welded-on vertical ports, as a result, no fluid remains in the housing sphere of the horizontal installation.

Various nominal widths are available. If required, please contact GEA Tuchenhagen to ask about the dimensions and feasibility.

Available nominal widths
On request

Available valve types	
Single-seat valves with shut-off function	N, U, N/ECO
Single-seat valves with divert function	W, X, W/ECO
Mixproof valves with shut-off function	K
Mixproof valves with shut-off function and seat lifting	-
Mixproof valves with divert function	-
Tank bottom valves	N, U, N/ECO, T_R

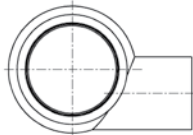

Tangential right
(view from the direction of the actuator)

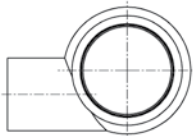

Tangential left
(view from the direction of the actuator)

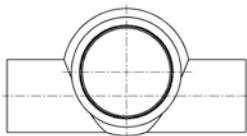

Tangential straight
(view from the direction of the actuator)

Technical data	
Material	1.4404/AISI 316 L
Product pressure	10 bar
Valve seat version	Clamped or welded housing connection

Incorporation of the option in the order code and example

Position	Description of the order code for options
13	Accessories /TR Tangential right /TL Tangential left /TT Tangential straight

Position	1	2	3	4/5	6	7	8	9	10	11	12	13	14 to 19
Code	N	T		- DN 80/DN 80 -	S	Z	- CD -	V0	-	1	2	N /52 /TT +	0 0 0 0 0 M





Typical application and description

As one of the basic elements of the VARIVENT® modular system, the actuator air/spring is used for performing the valve movement in all VARIVENT® valves.

The air supply is connected to the particular control and feedback system and led via the internal air channel under the piston surface of the actuator. Simply by reversing the actuator, it is possible to convert the fail-safe position of the valve (in single-seat valves) from spring-to-close (NC) to spring-to-open (NO). In these cases, or if the product or air supply pressure differs from the standard, check the definition of the actuator size based on the selection sheets onwards.

Available nominal widths		
Metric	DN	25 – 150
Inch OD	OD	1" – 6"
Inch IPS	IPS	2" – 6"

Available valve types	
Single-seat valves with shut-off function	N, U
Single-seat valves with divert function	W, X
Mixproof valves with shut-off function	D, B, R, L, C, K
Mixproof valves with shut-off function and seat lifting	D, B, R, L, M
Mixproof valves with divert function	Y
Tank bottom valves	N, U, T

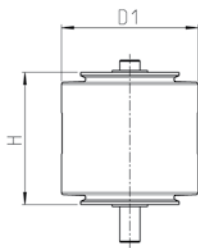

Technical data	
Material	1.4301
Outside surface	Turned, Ra ≤ 1.6 µm

Type	Dimensions			Type	Dimensions		
No. 8 in the order code	D1 [mm]	H [mm]	Weight [kg]	No. 8 in the order code	D1 [mm]	H [mm]	Weight [kg]
AA	99	95	3.2	BD5	140	140	5.1
BA	110	130	4.3	DD5	160	160	9.0
BB	110	130	4.5	DF5	170	170	10.4
BD	110	130	5.1	DG5	170	170	11.1
CA	135	130	5.7	ED5	160	160	12.3
CB	135	130	5.8	EF5	170	170	12.9
CD	135	130	6.2	EG5	170	170	13.5
CF	135	130	7.0	EH5	170	170	14.1
DB	170	160	8.0	DF6	170	199	13.5
DD	170	160	8.7	EF6	210	246	20.5
DF	170	160	9.6	EG6	210	246	21.7
DG	170	160	10.8	EH6	210	246	24.2
DH	170	160	11.4	EK6	210	246	25.5
ED	210	160	11.2	SG6	260	246	26.0
EF	210	160	12.1	SH6	260	246	28.4
EG	210	160	13.2	SK6	260	246	29.8
EH	210	160	13.8	SM6	260	246	33.4
				SN6	260	246	35.8

Incorporation of the option in the order code and example

Position	Description of the order code for options
6	Actuator type S Air/Spring
8	Actuator ... Acc. to actuator selection scheme (e.g. EF)

Position	1	2	3	4/5	6	7	8	9	10	11	12	13	14 to 19
Code	N	E		DN 80/DN 80	S	Z	EF	L0	1	2	N	/52	0 0 0 0 0 M



Typical application and description

As one of the basic elements of the ECOVENT® valves, the air/spring actuator type ECO-E is used for performing the valve movements in all ECOVENT® valves.

The air supply is connected to the particular control and feedback system and led via the internal air channel under the piston surface of the actuator. Simply by reversing the actuator, it is possible to convert the fail-safe position of the valve (in single-seat valves) from spring-to-close (NC) to spring-to-open (NO). In these cases, or if the product or air supply pressure differs from the standard, check the definition of the actuator size based on the selection sheets.

In addition, the actuator permits additional pressurization of the spring chamber with up to 6 bar air supply, in order to increase the closing force by this method. To pressurize the spring chamber with air, it is recommended that a NOT-element should be used in the control and feedback system T.VIS® (see section 9).

Available nominal widths		
Metric	DN	25 – 150
Inch OD	OD	1" – 6"
Inch IPS	IPS	2" – 6"

Available valve types	
Single-seat valves with shut-off function	N/ECO
Single-seat valves with divert function	W/ECO
Mixproof valves with shut-off function	–
Mixproof valves with shut-off function and seat lifting	–
Mixproof valves with divert function	–
Tank bottom valves	N/ECO

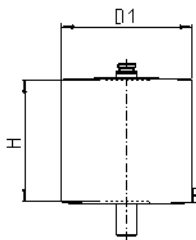

Technical data	
Material	1.4301
Outside surface	Turned, Ra ≤ 1.6 µm
Air supply pressure	Max. 8 bar
Air supply pressure air-supporting	Max. 6 bar

Type	Dimensions			
	No. 8 in the order code	D1 [mm]	H [mm]	Weight [kg]
EAA		99	95	1.9
EBA		110	130	2.8
EBB		110	130	2.9
ECA		135	130	3.9
ECB		135	130	4.0
ECD		135	130	4.6
EDB		170	160	6.6
EDD		170	160	7.2
EDF		170	160	8.2

Incorporation of the option in the order code and example

Position	Description of the order code for options
6	Actuator type
	E Air/Spring
8	Actuator
...	Acc. to actuator selection scheme (e.g. EDF)

Position	1	2	3	4/5	6	7	8	9	10	11	12	13	14 to 19
Code	N	E	/ECO	- DN 80/DN 80	-	E	Z	- EDF	-	L0	-	1 2 N /52	+ 0 0 0 0 0 M





Typical application and description

A basic element of ECOVENT® valves, the actuator air/spring of the ECO-E/US type is used for performing the valve movements in all ECOVENT® valves without control top.

Simply by reversing the actuator, it is possible to convert the fail-safe position of the valve from spring-to-close (NC) to spring-to-open (NO). In these cases, or if the product or air supply pressure differs from the standard, check the definition of the actuator size based on the selection sheets.

Available nominal widths		
Metric	DN	25 – 150
Inch OD	OD	1" – 6"
Inch IPS	IPS	2" – 6"

Available valve types	
Single-seat valves with shut-off function	N/ECO
Single-seat valves with divert function	W/ECO
Mixproof valves with shut-off function	–
Mixproof valves with shut-off function and seat lifting	–
Mixproof valves with divert function	–
Tank bottom valves	N/ECO

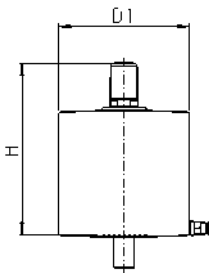

Technical data	
Material	1.4301
Outside surface	Turned, Ra ≤ 1.6 µm
Air supply pressure stroke	Max. 8 bar

Type	Dimensions			
	No. 8 in the order code	D1 [mm]	H [mm]	Weight [kg]
EAA		99	95	1.9
EBA		110	130	2.8
EBB		110	130	2.9
ECA		135	130	3.9
ECB		135	130	4.0
ECD		135	130	4.6
EDB		170	160	6.6
EDD		170	160	7.2
EDF		170	160	8.2

Incorporation of the option in the order code and example

Position	Description of the order code for options
6	Actuator type
	E Air/Spring
8	Actuator
	... Acc. to actuator selection scheme (e.g. ZDD)

Position	1	2	3	4/5	6	7	8	9	10	11	12	13	14 to 19
Code	N	E	/ECO	- DN 80/DN 80	- E	Z	- EDF	- L0	- 1	2	N	/52	+ 0 0 0 0 0 M



Typical application and description

For increasing the holding force of the actuator.

In addition to the function method of the VARIVENT® actuator air/spring, this actuator has another air connection to the spring side of the actuator. This connection enables the spring-side piston surface to be pressurized by compressed air.

To pressurize the spring side with air, it is recommended that a NOT-element should be used in the control and feedback system T.VIS® (see section 9).

Available nominal widths		
Metric	DN	25 – 150
Inch OD	OD	1" – 6"
Inch IPS	IPS	2" – 6"

Available valve types	
Single-seat valves with shut-off function	N, U
Single-seat valves with divert function	W, X
Mixproof valves with shut-off function	D, L, C, K
Mixproof valves with shut-off function and seat lifting	D, L
Mixproof valves with divert function	Y
Tank bottom valves	N, U

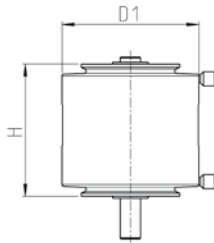

Technical data	
Material	1.4301
Outside surface	Turned, Ra ≤ 1.6 µm
Air supply pressure stroke	Max. 8 bar
Air supply pressure air-supporting	Max. 8 bar (actuator ZBB – ZDH) Max. 6 bar (actuator ZEF – ZSN6)

Type	Dimensions			
	No. 8 in the order code	D1 [mm]	H [mm]	Weight [kg]
ZBB		110	130	4.2
ZCB		135	130	5.3
ZCD		135	130	5.9
ZDD		170	160	9.8
ZDF		170	160	9.8
ZDG		170	160	10.6
ZDH		170	160	15.6
ZEF		210	160	12.1
ZEG		210	160	13.6
ZEH		210	160	14.1
ZEK6		210	246	25.2
ZSH6		260	246	29.3
ZSK6		260	246	30.7
ZSN6		260	246	38.8

Incorporation of the option in the order code and example

Position	Description of the order code for options
6	Actuator type Z Air/Spring
8	Actuator ... Acc. to actuator selection scheme (e.g. ZDD)

Position	1	2	3	4/5	6	7	8	9	10	11	12	13	14 to 19
Code	N	E		DN 80/DN 80	Z	Z	ZDP	L0	1	2	N	/52	0 0 0 0 0 M





Typical application and description

For increasing the size of the active pneumatic surface (piston surface) of the actuator.

The booster cylinder can be mounted in addition to the actuator so that the actuator can also be operated with low air supply pressure. In spring-to-close valves (valve type U with NO), the spring is installed below the actuator and in spring-to-open valves (valve type U with NC) between the actuator and control and feedback system. The booster cylinder is automatically supplied with compressed air without additional hosing via the internal air channel.

Available nominal widths		
Metric	DN	25 – 150
Inch OD	OD	1" – 6"
Inch IPS	IPS	2" – 6"

Available valve types	
Single-seat valves with shut-off function	N, U
Single-seat valves with divert function	W, X
Mixproof valves with shut-off function	D, B, R, C, K
Mixproof valves with shut-off function and seat lifting	D, B
Mixproof valves with divert function	Y
Tank bottom valves	N, U

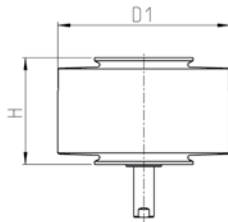

Technical data	
Material	1.4301
Outside surface	Turned, Ra ≤ 1.6 µm
Air supply pressure stroke	Max. 8 bar

Type	Dimensions		
	D1 [mm]	H [mm]	Weight [kg]
D	168	105	6.0
E	208	130	9.9
E6	208	130	9.9

The actuator sizes R..., S... and T... as well as T...6 and U...6 (position 8 in the code) resulting from the actuator selection schemes are a combination of an actuator type S air/spring and a booster cylinder. All symbols following the first letter relate to the actuator size. The combination is composed as follows:

No. 8 in the order code	Composed of		No. 8 in the order code	Composed of	
	Actuator	Booster cylinder		Actuator	Booster cylinder
RF	DG	D	TF6	EF6	E6
RG	DH	D	TG6	EG6	E6
RH	DF	D	TH6	EH6	E6
SF	EG	D	TK6	EK6	E6
SG	EH	D	UG6	SG6	E6
SH	EF	D	UH6	SH6	E6
TF	EG	E	UK6	SK6	E6
TG	EH	E	UN6	SN6	E6
TH	EF	E	UM6	SM6	E6

Incorporation of the option in the order code and example

Position	Description of the order code for options
8	Actuator ... Acc. to actuator selection scheme (e.g. TK6)

Position	1	2	3	4/5	6	7	8	9	10	11	12	13	14 to 19
Code	N	E		DN 80/DN 80	S	Z	TK6	L0	1	2	N	/52	0 0 0 0 0 M



Typical application and description

In the air/air actuator, both end positions are realized using pressurized air at the particular side of the piston. The actuator is not equipped with a spring in the inside.

If there is a failure with the air supply, the valve will remain in its particular position or its current position will be determined by the product pressure acting on the valve disc. For this reason, it is not permitted for an air/air actuator to be used on double-seat valves, because if there is a power failure the valve will not automatically return to its fail-safe position (closed position), but rather, the resulting position would be determined randomly based on the process conditions (product pressure or flow).

If an air/air actuator is required, please send your request to GEA Tuchenhagen stating the prevailing pressures (air supply and product pressure), nominal width and required valve type.

Available nominal widths		
Metric	DN	25–100
Inch OD	OD	1"–4"
Inch IPS	IPS	2"–4"

Available valve types	
Single-seat valves with shut-off function	N, U
Single-seat valves with divert function	W, X
Mixproof valves with shut-off function	–
Mixproof valves with shut-off function and seat lifting	–
Mixproof valves with divert function	–
Tank bottom valves	N, U

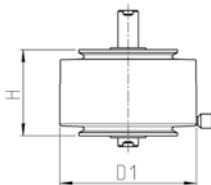

Technical data	
Material	1.4301
Outside surface	Turned, Ra ≤ 1.6 µm
Air supply pressure	Max. 8 bar

Type	Dimensions		
No. 8 in the order code	D1 [mm]	H [mm]	Weight [kg]
CJ	133	85	4.9

Incorporation of the option in the order code and example

Position	Description of the order code for options
6	Actuator type J Actuator air/air, indifferent
8	Actuator CJ

Position	1	2	3	4/5	6	7	8	9	10	11	12	13	14 to 19							
Code	N	E		- DN 80/DN 80 -	J	Z	- CJ -	L0	-	1	2	N	/52	+	0	0	0	0	0	M





Typical application and description

For manual operation of VARIVENT® valves.

The manual actuator is designed as a handwheel up to the nominal width DN 100 or 4". With larger nominal widths, the manual actuator is designed as a crank. The manual actuator can be locked in any position using a lock nut.

One full turn of the manual actuator results in a valve stroke of 11 mm, irrespective of the nominal width.

Available nominal widths		
Metric	DN	25 – 100
Inch OD	OD	1" – 6"
Inch IPS	IPS	2" – 6"

Available valve types	
Single-seat valves with shut-off function	N, N/ECO
Single-seat valves with divert function	W, X
Mixproof valves with shut-off function	D, B, R, L, C, K
Mixproof valves with shut-off function and seat lifting	D, B, R, L
Mixproof valves with divert function	Y
Tank bottom valves	N

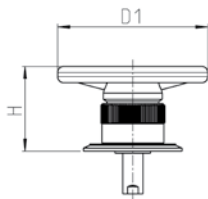

G1 and G2

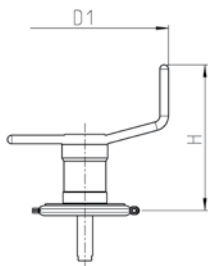

G6

Technical data	
Material	1.4301
Outside surface	Turned, Ra ≤ 1.6 µm

Nominal width	Type	Dimensions			
		No. 8 in order code	D1 [mm]	H [mm]	Weight [kg]
DN 25 – DN 50 1" – 2"	G1		148	107	2.7
DN 65 – DN 100 2 ½" – 4"	G2		198	113	3.1
DN 125 – DN 150 6"	G6		532	239	5.8

Incorporation of the option in the order code and example

Position	Description of the order code for options
6	Actuator type
	G Manual actuator
8	Actuator
...	Acc. to size (e.g. G2)

Position	1	2	3	4/5	6	7	8	9	10	11	12	13	14 to 19						
Code	N	E		- DN 80/DN 80 -	G	Z	G2	- L0 -	1	2	N	/52	+	0	0	0	0	0	0



Typical application and description

For manual operation of ECOVENT® valves.

This manual actuator is designed as a handwheel for the nominal widths DN 10 and DN 15.

Available nominal widths		
Metric	DN	10–15

Available valve types	
Single-seat valves with shut-off function	N_ECO small
Single-seat valves with divert function	W_ECO small
Mixproof valves with shut-off function	–
Mixproof valves with shut-off function and seat lifting	–
Mixproof valves with divert function	–
Tank bottom valves	–

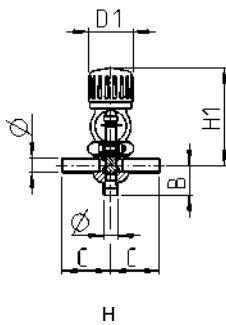

Technical data	
Material	PPH

Nominal width	Type	Dimensions			
		No. 8 in order code	D1 [mm]	H [mm]	Weight [kg]
DN 10	H		60	126	0.7
DN 15	H		60	129	0.7

Incorporation of the option in the order code and example

Position	Description of the order code for options
6	Actuator type
	H Manual actuator

Position	1	2	3	4/5	6	7	8	9	10	11	12	13	14 to 19							
Code	N	L	/ECO	- DN 10/DN 10	H	Z	-	-	V0	1	2	N	/52	+	0	0	0	0	0	0



Typical application and description

Perfluorinated rubber (FFKM) is an elastomer that is used in areas where particularly high thermal and/or chemical resistance properties are required.

FFKM seal material combines the chemical properties of PTFE and the mechanical properties of Viton, and is characterized by a wide range of application temperatures, very good resistance to fluids, low-pressure deformation and minimum swelling.

Available nominal widths		
Metric	DN	10–100
Inch OD	OD	1"–4"
Inch IPS	IPS	2"–4"

Available valve types	
Single-seat valves with shut-off function	N, N/ECO, U
Single-seat valves with divert function	W, W/ECO, X
Mixproof valves with shut-off function	D, C, K
Mixproof valves with shut-off function and seat lifting	D
Mixproof valves with divert function	–
Tank bottom valves	N, N/ECO, U

Technical data	
Operating temperature	–10 °C to 230 °C (14 °F to 446 °F)
Properties	See table of seal material properties

Incorporation of the option in the order code and example

Position	Description of the order code for options
10	Seal material in contact with the product
4	FFKM (FDA)

Position	1	2	3	4/5	6	7	8	9	10	11	12	13	14 to 19
Code	D	E		DN 80/DN 80	S	Z	CD	L0	4	2	N	/52	0 0 0 0 0 M



Typical application and description

Deviating from the quality of the standard surface quality (* DN/OD corresponding to Ra ≤ 0.8 µm; ** IPS corresponding to Ra ≤ 1.2 µm), different surface qualities are available up to a medium roughness for surfaces in contact with the product of Ra ≤ 0.4 µm. The outer surface of the housings is matte blasted as standard. Optionally, it can also be supplied ground.

Housings that should comply with the 3-A standard are produced as standard with an inner surface of Ra ≤ 0.8 µm with ground welds and a blasted outer surface. If a configuration with a ground outer surface is required, it is necessary to select not only option /3-A (position 13) but also the corresponding surface quality 3 (position 11).



Incorporation of the option in the order code and example

Position	Description of the order code for options
11	Surface quality of the housing
	1** Inside Ra ≤ 1.2 µm, outside matte blasted
	2* Inside Ra ≤ 0.8 µm, outside matte blasted
	3 Inside Ra ≤ 0.8 µm, outside ground
	4 Inside Ra ≤ 0.4 µm, outside matte blasted
	6 Inside Ra ≤ 0.5 µm, outside matte blasted
	7 Inside Ra ≤ 0.5 µm, outside ground
	8 Inside Ra ≤ 0.4 µm, outside ground

Position	1	2	3	4/5	6	7	8	9	10	11	12	13	14 to 19						
Code	D	E		- DN 80/DN 80 -	S	Z	- CD -	LO -	1	6	N	/52	+	0	0	0	0	0	M



Typical application and description

One process for improving the surface quality is electrochemical polishing, in which peaks on the surfaces of material are abraded by a galvanic process, resulting in an evened-out elevation profile.

This surface treatment makes it much less likely for contaminating substances and micro-organisms to stick to the surface. In addition, the smooth surface improves corrosion resistance by formation of an inert oxide layer.

Incorporation of the option in the order code and example

Position	Description of the order code for options
13	Accessories
	/E Surface finish electrolytically polished

Position	1	2	3	4/5	6	7	8	9	10	11	12	13	14 to 19							
Code	N	E		DN 80/DN 80	S	Z	G2	L0	1	3	N	/E	/52	+	0	0	0	0	0	M

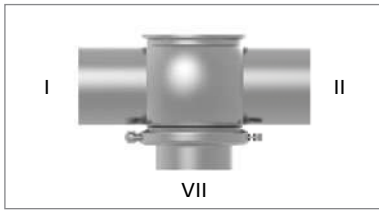

Valves with one housing and vertical port

Typical application and description

The valve housings can be specified with a welded-on connection fitting. To find which connection fittings are available, please refer to the list on the following pages.

If the vertical ports within a valve do have different configurations, please inform us of the designation for the particular housing port including the required connection fitting (as in the example below). The seal which may be included corresponds to the sealing material of the valve.

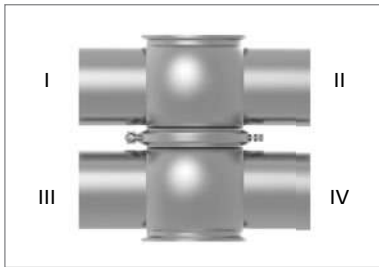

Valves with two housings

Connection fittings	
TK	VARIVENT® flange connection, groove flange on housing
TN	VARIVENT® groove flange incl. O-ring and connecting parts
TF	VARIVENT® smooth flange
GK	Pipe fitting, DIN 11851, male end on housing
GO	Male end SC, DIN 11851, incl. sealing ring G
KO	Liner SD, DIN 11851, incl. groove nut
ASK	Hygienic flange connection, DIN 11853-2
NFK	Hygienic groove flange, DIN 11853-2
BFK	Hygienic flange, DIN 11853-2
CO	Clamp connection/TRI-Clamp, DIN 32676 (DN)/ISO 2852 (OD)

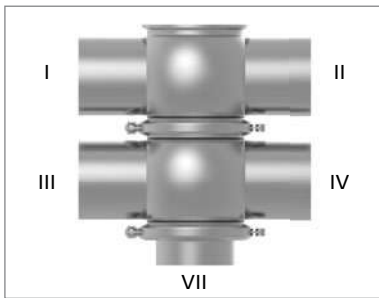

Valves with two housings and vertical port

Example

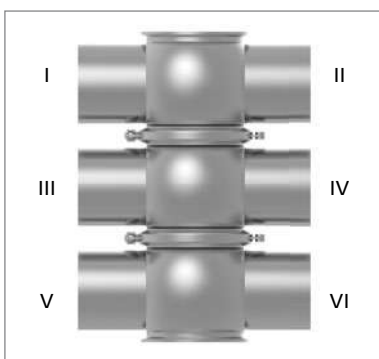

Valves with three housings

Housing port	Connection fitting
I	TN
II	TF
III	TK
IV	
V	
VI	
VII	

Incorporation of the option in the order code and example

Position	Description of the order code for options
12	Connection fittings
	J Valve with connection fittings (required connection fitting acc. to list above, please specify separately)

Position	1	2	3	4/5	6	7	8	9	10	11	12	13	14 to 19	
Code	N	A		- DN 80/DN 80 -	S	Z	- CD -	L0	-	1	2	J	/52	+ 0 0 0 0 0 M



Typical application and description

An O-ring is used for sealing the VARIVENT® flange connection, and is given a defined compression by a metal stop. The O-ring is also protected by the special geometry of the recess from being pulled out at high flow rates.

The VARIVENT® flange connection (TK) can be ordered either as a complete connection including bolts and nuts (TK) or a groove flange (TN)/smooth flange (TF) as a connection fitting on a vertical port. If a complete connection is ordered as the connection fitting, the groove flange is welded onto the housing. The groove flange (TN) contains not only the O-Ring but also the required connecting elements.



Complete connection including bolts and nuts (TK)



Groove flange (TN), including connecting elements and sealing ring



Smooth flange (TF)

Available nominal widths		
Metric	DN	25 – 150
Inch OD	OD	1" – 6"
Inch IPS	IPS	2" – 6"

Technical data	
Material	1.4404
Surface in contact with the product	Ra ≤ 0.8 µm
Certificates	3.1/AD2000W2
Seal materials	EPDM (FDA), FKM (FDA), HNBR (FDA)

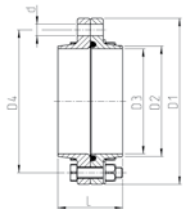

TK = VARIVENT® flange connection

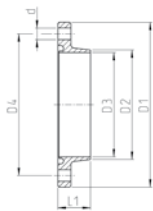

TN = VARIVENT® groove flange

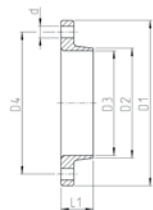

TF = VARIVENT® smooth flange

Nominal width	Dimensions							O-ring	
	D1 [mm]	D2 [mm]	D3 [mm]	D4 [mm]	d [mm]	L [mm]	L1 [mm]	[mm]	PS
DN 25	70	30.0	26.0	53	4 × Ø 9	50	25	25.0 × 5.0	16
DN 40	82	42.0	38.0	65	4 × Ø 9	50	25	36.0 × 5.0	16
DN 50	94	54.0	50.0	77	4 × Ø 9	50	25	47.0 × 5.0	16
DN 65	113	70.0	66.0	95	8 × Ø 9	50	25	62.0 × 5.0	16
DN 80	128	85.0	81.0	110	8 × Ø 9	50	25	75.0 × 5.0	10
DN 100	159	104.0	100.0	137	8 × Ø 11	50	25	95.0 × 5.0	10
DN 125	183	129.0	125.0	161	8 × Ø 11	50	25	115.0 × 5.0	10
DN 150	213	154.0	150.0	188	8 × Ø 14	60	30	134.2 × 5.7	10
OD 1"	66	25.5	22.0	49	4 × Ø 9	50	25	25 × 5.0	16
OD 1 ½"	79	38.5	35.0	62	4 × Ø 9	50	25	36 × 5.0	16
OD 2"	91	51.0	47.5	74	4 × Ø 9	50	25	47 × 5.0	16
OD 2 ½"	106	63.5	60.0	88	8 × Ø 9	50	25	62 × 5.0	16
OD 3"	119	76.5	73.0	101	8 × Ø 9	50	25	75 × 5.0	10
OD 4"	156	102.0	97.5	134	8 × Ø 11	50	25	95 × 5.0	10
OD 6"	211	152.4	146.5	186	8 × Ø 11	50	25	115 × 5.0	10
IPS 2"	101	60.5	57.0	84	4 × Ø 9	50	25	25 × 5.0	16
IPS 3"	132	89.0	85.0	114	4 × Ø 9	50	25	36 × 5.0	10
IPS 4"	169	114.0	110.0	147	4 × Ø 9	50	25	47 × 5.0	10
IPS 6"	227	168.0	162.0	202	8 × Ø 9	50	25	62 × 5.0	10

Incorporation of the option in the order code and example

Position	Description of the order code for options
12	Connection fittings
J	Valve with connection fittings (please specify option TK, TN or TF separately with reference to the connection)

Position	1	2	3	4/5	6	7	8	9	10	11	12	13	14 to 19									
Code	N	E		- DN 80/DN 80 -	S	Z	-	CD	-	L0	-	1	2	J	/52	+	0	0	0	0	0	M

Typical application and description

A sealing ring G is used for sealing the pipe fitting acc. to DIN 11851.

The pipe fitting acc. to DIN 11851 can be ordered either as a complete connection (GK) or male end SC (GO)/liner SD (KO)

as a connection fitting on a vertical port. If a complete connection is ordered on a housing port, the male end is welded onto the housing. The groove flange contains the sealing ring G. The liner (KO) contains the groove nut.



Complete connection (GK)



Male end SC (GO), including sealing ring G



Liner SD (KO), including groove nut

GK – Complete connection, male end on housing

Available nominal widths		
Metric	DN	10–150
Inch OD	OD	1"–4"

Technical data	
Material	1.4404 / AISI 316L
Standard	DIN 11851

GO – Male end SC, including sealing ring G

Available nominal widths		
Metric	DN	10–150
Inch OD	OD	1"–4"

Technical data	
Material	1.4404 / AISI 316L
Standard	DIN 11851

KO – Liner SD, including groove nut

Available nominal widths		
Metric	DN	10–150
Inch OD	OD	1"–4"

Technical data	
Material	1.4404 / AISI 316L
Standard	DIN 11851

Incorporation of the option in the order code and example

Position	Description of the order code for options
12	Connection fittings
	J Valve with connection fittings (required connection fitting, please specify separately)

Position	1	2	3	4/5	6	7	8	9	10	11	12	13	14 to 19					
Code	N	E		DN 80/DN 80	S	Z	CD	L0	1	2	J	/52	+	0	0	0	0	M



Typical application and description

An O-ring is used for sealing the hygienic flange connection acc. to DIN 11853-2, and is given a defined compression by a metal stop. The O-ring is also protected by the special geometry of the recess from being pulled out at high flow rates. Furthermore, the flange connection is centered by the design shape. The sealing geometry of the hygienic flange connection corresponds to the aseptic flange connection acc. to DIN 11864-2.

The hygienic flange connection (ASK) can be ordered either as a complete connection including bolts and nuts (ASK) or a hygienic groove flange (NFK)/hygienic flange (BFK) as a connection fitting on a vertical port. If a complete connection is ordered on a housing port, the groove flange is welded onto the housing. The groove flange (NFK) contains not only the O-Ring but also the required connecting elements.



Complete hygienic flange connection (ASK)



Hygienic-groove flange (NFK), including connecting elements and sealing ring



Hygienic flange (BFK)

ASK – Complete hygienic flange connection

Available nominal widths		
Metric	DN	10–150
Inch OD	OD	1"–4"

Technical data	
Material	1.4404 / AISI 316L
Seal material	EPDM (FDA), FKM (FDA), HNBR (FDA)
Standard	DIN 11853-2

NFK – Hygienic groove flange, including connecting elements and seal

Available nominal widths		
Metric	DN	10–150
Inch OD	OD	1"–4"

Technical data	
Material	1.4404 / AISI 316L
Seal material	EPDM (FDA), FKM (FDA), HNBR (FDA)
Standard	DIN 11853-2

BFK – Hygienic flange

Available nominal widths		
Metric	DN	10–150
Inch OD	OD	1"–4"

Technical data	
Material	1.4404 / AISI 316L
Standard	DIN 11853-2

Incorporation of the option in the order code and example

Position	Description of the order code for options				
12	<table border="1"> <thead> <tr> <th colspan="2">Connection fittings</th> </tr> </thead> <tbody> <tr> <td>J</td> <td>Valve with connection fittings (required connection fitting, please specify separately)</td> </tr> </tbody> </table>	Connection fittings		J	Valve with connection fittings (required connection fitting, please specify separately)
Connection fittings					
J	Valve with connection fittings (required connection fitting, please specify separately)				

Position	1	2	3	4/5	6	7	8	9	10	11	12	13	14 to 19									
Code	N	E		- DN 80/DN 80 -	S	Z	-	CD	-	L0	-	1	2	J	/52	+	0	0	0	0	0	M

Typical application and description

The clamp connection acc. to DIN 32676 is a widely used connection fitting, especially in North America. The connection uses a symmetrically structured clamp connection with a seal located in between it, and is secured by a clamp. The second clamp connection, the seal and the clamp are not supplied.



Clamp connection (CO)

CO – Clamp connection

Available nominal widths		
Metric	DN	25–150
Inch OD	OD	1"–4"

Technical data		
Material	DN	1.4404 / AISI 316L
	OD	AISI 316L
Standard	DN	DIN 32676
	OD	ISO 2852
Certificates		3.1

Incorporation of the option in the order code and example

Position	Description of the order code for options										
12	Connection fittings J Valve with connection fittings (required connection fitting, please specify separately)										

Position	1	2	3	4/5	6	7	8	9	10	11	12	13	14 to 19					
Code	N	E		DN 80/DN 80	S	Z	CD	LO	1	2	J	/52	0	0	0	0	0	M





Typical application and description

To avoid water hammers when the valve disc of VARIVENT® valves is closed in the flow direction.

The oil-filled damping cylinder enables the closing speed of VARIVENT® valves to be kept constant throughout the entire stroke length. The closing speed can be set using an adjustable throttle valve on the bypass.

The application is recommended when the installed valve closes in the flow direction of the product, and cannot be converted to a valve variant intended for this flow direction.

Available nominal widths		
Metric	DN	25 – 150
Inch OD	OD	1" – 6"
Inch IPS	IPS	2" – 6"

Available valve types	
Single-seat valves with shut-off function	N, U
Single-seat valves with divert function	W, X
Mixproof valves with shut-off function	D, B, R, L, C, K
Mixproof valves with shut-off function and seat lifting	D, B
Mixproof valves with divert function	Y
Tank bottom valves	N, U, T*

* Not possible with lifting actuator

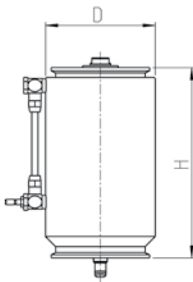

Technical data	
Type	R7
Material	1.4301
Filling fluid	Synthetic lubricating oil for the foodstuffs industry acc. to NSF-H1, Rivolta F.L. 50

Type	Dimensions		
	d [mm]	H [mm]	Weight [kg]
R7	108	188	7.9

Incorporation of the option in the order code and example

Position	Description of the order code for options
13	Accessories
/12	Damping cylinder with bypass

Position	1	2	3	4/5	6	7	8	9	10	11	12	13	14 to 19						
Code	N	E		DN 80/DN 80	S	Z	RG	LO	1	2	N	/12	/52	+	0	0	0	0	M



Typical application and description

Setting the coarse and fine flow when dosing or weighing at a bottling station.

With the two-position-stop (cylinder), a pneumatically operated valve can be moved to two reproducible positions in addition to the closed position. A partial stroke and a full stroke, or two partial strokes, can be set.

Available nominal widths		
Metric	DN	25 – 150
Inch OD	OD	1" – 6"
Inch IPS	IPS	2" – 6"

Available valve types	
Single-seat valves with shut-off function	N, U
Single-seat valves with divert function	W, X
Mixproof valves with shut-off function	D, B, C, K
Mixproof valves with shut-off function and seat lifting	D, B
Mixproof valves with divert function	Y
Tank bottom valves	N, U

Only for spring-to-close valves, in type U only spring-to-open valves possible!

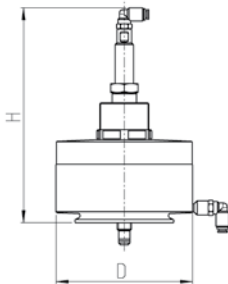

Technical data	
Material	1.4301
Setting of the strokes	Mechanically using threaded pieces and adjustment screw
Control and feedback system	Feedback on the valve position is possible by using proximity switches in the lantern

Type	Dimensions					
	For valves with actuator size*	d [mm]	H [mm]	Max. partial stroke [mm]	Max. stroke [mm]	Weight [kg]
AS	A...	98	216	17	30	2.7
CS	B..., C...	135	218	30	30	3.7
DS	D...	170	222	33	40	5.8
ES	E...	210	222	33	40	7.7
SS 6	E...6, S...6	260	282	55	60	13.0

* See position 8 in the code

Incorporation of the option in the order code and example

Position	Description of the order code for options
8	Actuator (spring-to-close) /Lifting actuator .../... Required combination of main actuator / two-position stop according to the actuator selection sheet and corresponding two-position stop (cylinder)
13	Accessories /16 Two-position-stop (cylinder)

Position	1	2	3	4/5	6	7	8	9	10	11	12	13	14 to 19
Code	N	E		DN 80/DN 80	S	Z	CD/CS	L0	1	2	N	/16 /52	0 0 0 0 0 M





Typical application and description

Mechanically adjustable limit on the stroke.

The maximum stroke can be reduced by using a mechanically adjustable limit stop. The limit stop limits either the opening or the closing stroke of the valve. The minimum stroke is 5 mm.

It is not possible to install a proximity switch as a feedback function in the lantern!

NOTE: The limit stop can not be used simultaneously with a sterile lock.

Available nominal widths		
Metric	DN	25–150
Inch OD	OD	1"–6"
Inch IPS	IPS	2"–6"

Available valve types	
Single-seat valves with shut-off function	N, U
Single-seat valves with divert function	W, X
Mixproof valves with shut-off function	C, K*
Mixproof valves with shut-off function and seat lifting	–
Mixproof valves with divert function	–
Tank bottom valves	N, U

Technical data	
Material	1.4301
Setting possibility	Limitation of the stroke in closing or opening direction; only possible for single-seat valves

		Type	Dimensions	Type	Dimensions
Valve type		N, U, C		K*	
Nominal width			Weight [kg]		Weight [kg]
DN 25	OD 1"	N 25–50	0.4	–	–
DN 40	OD 1 ½"	N 25–50	0.4	K 40–100	0.5
DN 50	OD 2"	IPS 2"	0.4	K 40–100	0.5
DN 65	OD 2 ½"	N 65–100	0.7	K 40–100	0.5
DN 80	OD 3"	IPS 3"	0.7	K 40–100	0.5
DN 100	OD 4"	IPS 4"	0.7	K 40–100	0.5
DN 125		N 125–6"IPS	1.1	–	–
DN 150	OD 6"	IPS 6"	1.1	–	–

* Only for stroke limitation when opening the valve

Incorporation of the option in the order code and example

Position	Description of the order code for options
13	Accessories
	/20 Limit stop, opening
	/21 Limit stop, closing

Position	1	2	3	4/5	6	7	8	9	10	11	12	13	14 to 19
Code	N	E		DN 80/DN 80	S	Z	RG	LO	1	2	N	/20 /52	0 0 0 0 0 M



Typical application and description

For reliable separation between the surface of the valve disc in contact with the product and the atmosphere.

Applying sterilizing media to the sterile lock prevents contamination of the product from atmosphere due to the switching movement of the valve stem ("elevator effect").

If the media has a tendency towards crystallisation, this effect can be avoided by pressurizing the sterile lock with a liquid and securing the shaft seal against damage.

NOTE: The limit stop can not be used simultaneously with a sterile lock.

Available nominal widths		
Metric	DN	25 – 150
Inch OD	OD	1" – 6"
Inch IPS	IPS	2" – 6"

Available valve types	
Single-seat valves with shut-off function	N, U
Single-seat valves with divert function	W, X
Mixproof valves with shut-off function	C
Mixproof valves with shut-off function and seat lifting	–
Mixproof valves with divert function	–
Tank bottom valves	N, U

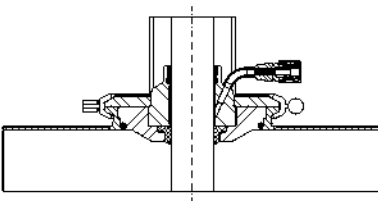

Technical data	
Material	1.4301
Barrier media	e.g. sterile water, condensate, steam
IMPORTANT: The sterile lock is not suitable for permanent vapor application. Brief actuation is recommended after or before the switching procedure.	

Nominal width			Dimensions	
			Connection [mm]	Weight [kg]
DN 25	OD 1"		6/4	0.4
DN 40	OD 1 ½"		6/4	0.8
DN 50	OD 2"	IPS 2"	6/4	0.8
DN 65	OD 2 ½"		6/4	1.5
DN 80	OD 3"	IPS 3"	6/4	1.5
DN 100	OD 4"	IPS 4"	6/4	2.6
DN 125			6/4	5.9
DN 150	OD 6"	IPS 6"	6/4	7.2

Incorporation of the option in the order code and example

Position	Description of the order code for options
13	Accessories
	/24 Flushing lock complete

Position	1	2	3	4/5	6	7	8	9	10	11	12	13	14 to 19
Code	N	E		- DN 80/DN 80 -	S	Z	- CD -	LO -	1	2	N	/24 /52	+ 0 0 0 0 0 M





Typical application and description

For reliable separation between the surface of the valve disc in contact with the product and the atmosphere.

Applying sterilizing media to the sterile lock prevents contamination of the product from atmosphere due to the switching movement of the valve stem ("elevator effect").

If the media has a tendency towards crystallization, this effect can be avoided by pressurizing the sterile lock with a liquid and securing the shaft seal against damage. If this option is selected with double-seat valves, both the upper and the lower stem feedthrough will be equipped with a sterile lock.

Available nominal widths		
Metric	DN	25 – 150
Inch OD	OD	1" – 6"
Inch IPS	IPS	2" – 6"

Available valve types	
Single-seat valves with shut-off function	–
Single-seat valves with divert function	–
Mixproof valves with shut-off function	D, B, R
Mixproof valves with shut-off function and seat lifting	D, B, R
Mixproof valves with divert function	Y
Tank bottom valves	–

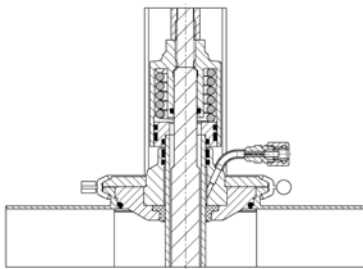

for VARIVENT® type D, Y:

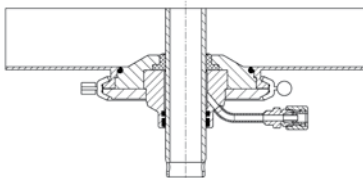

for VARIVENT® type B, R:

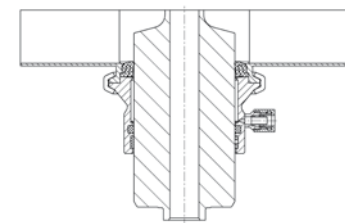

Technical data	
Material	1.4301
Barrier media	e.g. sterile water, condensate, steam
IMPORTANT: The sterile lock is not suitable for permanent vapor application. Brief actuation is recommended after or before the switching procedure.	

Valve type	Dimensions					
	D, Y		B		R	
Connection upper sterile lock	6/4 mm		6/4 mm		6/4 mm	
Nominal width	Lower sterile lock		Connection [mm]	Weight* [kg]	Connection [mm]	Weight* [kg]
	DN 25	OD 1"	6/4	0.8	–	–
DN 40	OD 1 1/2"	6/4	1.6	–	–	
DN 50	OD 2"	IPS 2"	6/4	1.6	8/6	1.4
DN 65	OD 2 1/2"	6/4	6/4	3.0	8/6	2.7
DN 80	OD 3"	IPS 3"	6/4	3.0	8/6	2.7
DN 100	OD 4"	IPS 4"	6/4	5.2	8/6	4.3
DN 125			6/4	11.8	8/6	8.4
DN 150	OD 6"	IPS 6"	6/4	14.2	8/6	10.4

* Complete, upper and lower sterile lock

Incorporation of the option in the order code and example

Position	Description of the order code for options
13	Accessories
	/24 Flushing lock complete (top and bottom)

Position	1	2	3	4/5	6	7	8	9	10	11	12	13	14 to 19
Code	D	E		DN 80/DN 80	S	Z	CD	L0	1	2	N	/24 /52	0 0 0 0 0 M



Typical application and description

For reliable separation between the surface of the lower valve disc in contact with the product and the atmosphere.

Applying sterilizing media to the sterile lock prevents contamination of the product from atmosphere due to the switching movement of the valve stem (“elevator effect”).

If the media has a tendency towards crystallization, this effect can be avoided by pressurizing the sterile lock with a liquid and securing the shaft seal against damage.

Available nominal widths		
Metric	DN	40–150
Inch OD	OD	1 ½"–6"
Inch IPS	IPS	2"–6"

Available valve types	
Single-seat valves with shut-off function	–
Single-seat valves with divert function	–
Mixproof valves with shut-off function	B, R
Mixproof valves with shut-off function and seat lifting	B, R
Mixproof valves with divert function	–
Tank bottom valves	–

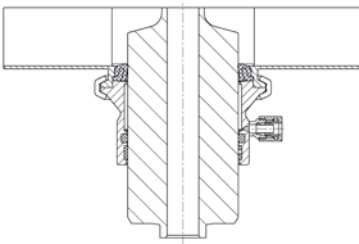

Technical data	
Material	1.4301
Barrier fluid	e.g. sterile water, condensate, steam
IMPORTANT: The sterile lock is not suitable for permanent vapor application. Brief actuation is recommended after or before the switching procedure.	

Valve type			Dimensions			
			B		R	
Nominal width			Connection [mm]	Weight [kg]	Connection [mm]	Weight [kg]
DN 40	OD 1 ½"		–	–	8/6	0.6
DN 50	OD 2"	IPS 2"	8/6	0.6	8/6	0.6
DN 65	OD 2 ½"		8/6	1.2	8/6	1.0
DN 80	OD 3"	IPS 3"	8/6	1.2	8/6	1.0
DN 100	OD 4"	IPS 4"	8/6	1.7	8/6	1.4
DN 125			8/6	2.5	8/6	2.3
DN 150	OD 6"	IPS 6"	8/6	3.2	8/6	2.7

Incorporation of the option in the order code and example

Position	Description of the order code for options
13	Accessories /23 Balancer flushing lock (bottom)

Position	1	2	3	4/5	6	7	8	9	10	11	12	13	14 to 19	
Code	R	E		- DN 80/DN 80 -	S	Z	- DD5 -	L0	-	1	2	N	/23 /52 +	0 0 0 0 0 M

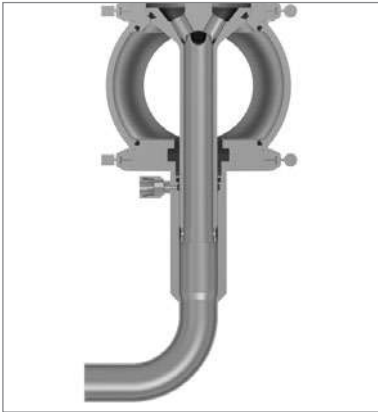

Typical application and description

For controlled collection of the leakage in double-seat valves without dripping pan or funnel, e.g. valves installed outside of manifolds.

The leakage connector is used for individual collection of switching leakages and cleaning media during cleaning of the leakage chamber.

The leakage outlet should be flushed regularly through the cleaning connection!

Available nominal widths		
Metric	DN	40–150
Inch OD	OD	1 ½"–6"
Inch IPS	IPS	2"–6"

Available valve types	
Single-seat valves with shut-off function	–
Single-seat valves with divert function	–
Mixproof valves with shut-off function	D
Mixproof valves with shut-off function and seat lifting	D
Mixproof valves with divert function	Y
Tank bottom valves	–

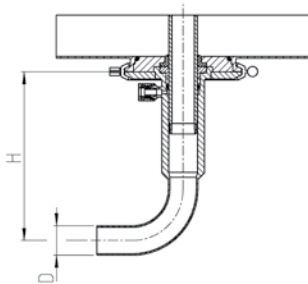

Technical data	
Material	1.4301
Surface in contact with the product	Ra ≤ 0.8 µm
Outside surface	Matte blasted

Nominal width			Dimensions			
			Ø [mm]	d [mm]	H [mm]	Weight [kg]
DN 25	OD 1"		29	6/4	122	0.4
DN 40	OD 1 ½"		29	8/6	147	0.8
DN 50	OD 2"	IPS 2"	29	8/6	147	0.8
DN 65	OD 2 ½"		29	8/6	166	1.2
DN 80	OD 3"	IPS 3"	29	8/6	166	1.2
DN 100	OD 4"	IPS 4"	29	8/6	166	1.2
DN 125			30	10/8	105	1.8
DN 150	OD 6"	IPS 6"	30	10/8	105	1.8

Incorporation of the option in the order code and example

Position	Description of the order code for options
13	Accessories
	/26 Leakage connector

Position	1	2	3	4/5	6	7	8	9	10	11	12	13	14 to 19							
Code	D	E		DN 80/DN 80	S	Z	CD	LO	1	2	N	/26	/52	+	0	0	0	0	0	M

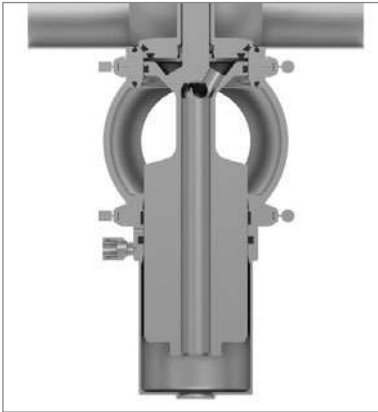

Typical application and description

For controlled collection of the leakage in double-seat valves without dripping pan or funnel, e.g. valves installed outside of manifolds.

The leakage connector is used for individual collection of switching leakages and cleaning media during cleaning of the leakage chamber.

The leakage outlet should be flushed regularly through the cleaning connection!

Available nominal widths		
Metric	DN	40–100
Inch OD	OD	1 ½"–4"
Inch IPS	IPS	2"–4"

Available valve types	
Single-seat valves with shut-off function	–
Single-seat valves with divert function	–
Mixproof valves with shut-off function	B, R
Mixproof valves with shut-off function and seat lifting	B, R
Mixproof valves with divert function	–
Tank bottom valves	–

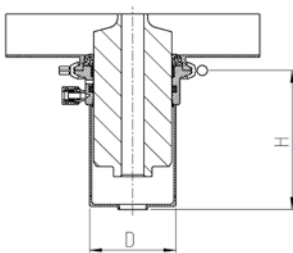

Technical data	
Material	1.4301
Surface in contact with the product	Ra ≤ 0.8 µm
Outside surface	Matte blasted

			Dimensions			
Nominal width			Ø [mm]	d [mm]	H [mm]	Weight [kg]
DN 40	OD 1 ½"		26	8/6	147.5	0.9
DN 50	OD 2"	IPS 2"	26	8/6	147.5	0.9
DN 65	OD 2 ½"		26	8/6	136.5	1.3
DN 80	OD 3"	IPS 3"	26	8/6	136.5	1.3
DN 100	OD 4"	IPS 4"	26	8/6	143.5	1.9

Incorporation of the option in the order code and example

Position	Description of the order code for options
13	Accessories
/26	Leakage connector

Position	1	2	3	4/5	6	7	8	9	10	11	12	13	14 to 19	
Code	R	E		- DN 80/DN 80 -	S	Z	- DD5 -	L0	-	1	2	N	/26 /52 +	0 0 0 0 0 M





Typical application and description

Leakage detection in case of seal defects on the double-seal valve type C.

If there is no need to flush the leakage chamber in a double-seal valve type C, the valve can be equipped with only one flushing valve. In this case, the flushing valve is not used for flushing, but only for leakage detection in case of defects.

Available nominal widths		
Metric	DN	25 – 150
Inch OD	OD	1" – 4"

Available valve types	
Single-seat valves with shut-off function	–
Single-seat valves with divert function	–
Mixproof valves with shut-off function	C
Mixproof valves with shut-off function and seat lifting	–
Mixproof valves with divert function	–
Tank bottom valves	–



Technical data	
Material	1.4301 / PVDF
Leakage connection	8/6 mm
Pressure leakage channelling	Pressureless

Incorporation of the option in the order code and example

Position	Description of the order code for options
13	Accessories
	/27 Version with only one flushing valve

Position	1	2	3	4/5	6	7	8	9	10	11	12	13	14 to 19
Code	C	T		DN 80/DN 80	S	Z	CD	V0	1	2	N	/27 /52	0 0 0 0 0 M



Typical application and description

A cleaning connection is installed at the level of the lantern for spray cleaning the double-seat valves with cleaning media. Cleaning media flows through the connection to the feed valve in the periphery. All components that require this, as well as a meter of PTFE hose, can be supplied with the valve or ordered as a module.

As an option, it is also possible to make the spray cleaning connection a blind connection. Making the cleaning connection a blind is only intended for transport purposes, to prevent dust/particles from penetrating the cleaning connection. During operation of the valve, it is not recommended for the cleaning connection to use such a blind.

Available nominal widths		
Metric	DN	25 – 150
Inch OD	OD	1" – 6"
Inch IPS	IPS	2" – 6"

Available valve types	
Single-seat valves with shut-off function	–
Single-seat valves with divert function	–
Mixproof valves with shut-off function	D, B, R, L
Mixproof valves with shut-off function and seat lifting	D, B, R, L
Mixproof valves with divert function	Y
Tank bottom valves	T



Example installation

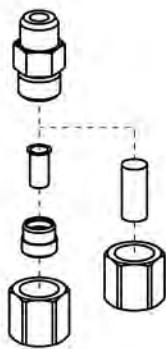

	Nominal width					
	DN 25, OD 1"		DN 40–100, OD 1 ½"–4", IPS 2"–4"		DN 125–150, OD 6", IPS 6"	
One metre CIP hose with connection parts for double-seat valves; parts contained	Ø size	Article number	Ø size	Article number	Ø size	Article number
PTFE hose, 1 m	6/4		8/6		10/8	
Support tube	6		8		10	
Olive	6	221-105.78	8	221-105.79	10	221-105.80
Union nut	12		14		16	
Weld-on vertical port	6		8		10	
CIP connection blind	Ø size	Article number	Ø size	Article number	Ø size	Article number
	6	915-089	8	915-068	10	915-090

Incorporation of the option in the order code and example

Position	Description of the order code for options
13	Accessories
	/32 1 m CIP hose with connection parts for double-seat valves
	/36 CIP connection blind

Position	1	2	3	4/5	6	7	8	9	10	11	12	13	14 to 19
Code	D	E		DN 80/DN 80	S	Z	CD	L0	1	2	N	/32 /52	0 0 0 0 0 M



Typical application and description

Optionally, the housings or all parts in contact with the product can be supplied with a test report 2.2 and/or an inspection certificate 3.1 acc. to EN 10204.

IMPORTANT: An inspection certificate for all components in contact with the product can only be produced if notification of this requirement is provided with the order. The inspection certificate 3.1 acc. to EN 10204 can only be issued subsequently for the housings. Unless special requirements are stated, the order code referred to below only covers issuing the inspection certificate 3.1 acc. to EN 10204 for the housings.

European standard EN 10204 in its 2004 edition defines the various types of test certificate that can be issued to the ordering party in accordance with the agreements in the order for delivery of metallic products.

Number	Type of test certificate	Content of the certificate	Confirmation of the certificate by
2.2	Test report	Confirmation of compliance with the order, specifying results of a non-specific test	The manufacturer
3.1	Inspection certificate 3.1*	Confirmation of compliance with the order, specifying results of a specific test	The manufacturer's acceptance officer independent of the production department

* Inspection certificates 3.1* can be selected either for the housing or for product wetted parts connection fittings, incl. connection fittings or ADW2 (please specify when ordering).

Incorporation of the option in the order code and example

Position	Description of the order code for options
13	Accessories
	/41 Test report 2.2
	/42 Inspection certificate 3.1 acc. to EN 10204

Position	1	2	3	4/5	6	7	8	9	10	11	12	13	14 to 19
Code	D	E		DN 80/DN 80	S	Z	CD	L0	1	2	N	/41 /52	0 0 0 0 0 M





Typical application and description

If no alternative identification option is selected, the valves are always provided with a nameplate for clear identification (option /52). All key information required for clear allocation of the valve, as well as technical data, is specified on the nameplate. The plate is glued onto the actuator. If the required identification number is specified, this is allocated to the valve by means of a separate sticker on the actuator or control and feedback system.

Key data contained	
Valve type	
Serial number	
Materials in contact with the product	Metallic material / seal material
Air supply pressure	Min./Max. [bar/psi]
Product pressure	Housing 1/2/3 [bar/psi]



Option /50 – engraved labeling plate cpl. for system identification number

In addition to the nameplate, the option /50 consists of an engraved labeling plate attached between the actuator and lantern using a key ring on the clamp connection.



Option /51 – metal labeling plate US version cpl.

The engraved labeling plate is attached between the actuator and lantern using a key ring on the clamp connection. Additional information can be recorded as well as the TAG number, customer designation and the valve type. In addition, the valve is identified with a nameplate.



Option /55 – valve identification with TAG number (yellow)

Option /55 consists of a carrier for up to 10 characters made of plastic which is attached to the actuator with cable carriers. For clear identification, the valve is additionally provided with a nameplate.



Option /56 – valve identification with TAG number (yellow)

Option /56 consists of two carriers for up to 10 characters each made of plastic which are attached to the actuator with cable carriers. For clear identification, the valve is additionally provided with a nameplate.

Incorporation of the option in the order code and example

Position	Description of the order code for options
13	Accessories
	/50 Engraved metal plate
	/51 Metal plate (US version)
	/52 Adhesive ID tag
	/55 Valve identification 10 numbers on carrier
	/56 Valve identification 20 numbers on carrier

Position	1	2	3	4/5	6	7	8	9	10	11	12	13	14 to 19							
Code	D	E		- DN 80/DN 80 -	S	Z	- CD -	L0	-	1	2	N	/50	+	0	0	0	0	0	M



Typical application and description

3-A Sanitary Standards, Inc. is an independent, non-profit corporation dedicated to advancing hygienic equipment design for the food, beverage, and pharmaceutical industries. In particular, it represents the interests of three stakeholder groups in the US dairy industry with a common commitment to promoting food safety and the public health — regulatory sanitarians, equipment fabricators and processors. To achieve this purpose, it has produced guidelines which define various design requirements on components. In the area of seat valves, it is above all the standards 53-06 (compression type valves) and 85-02 (double-seat mixproof valves) that are relevant. Compliance with these design specifications is examined by an independent expert and confirmed by issuing a certificate. Almost the entire VARIVENT® and ECOVENT® valve series complies with these design specification in the standard design acc. to section 1.

If the 3-A option is selected, compliance of the valve with the requirements of the standard is confirmed by means of a sticker on the component. Consequently, if this option is selected, it is necessary to comply with the standard in terms of identification as well.

Furthermore, when this option is selected, the welds of the port connections are ground smooth. The standard does not specify that this is mandatory, but it is in line with customers' preferences in this market.

IMPORTANT: The standard surface when this option is selected is “inside surface Ra ≤ 0.8 µm, outside matte”. Many customers in this market ask for the alternative surface quality “inside surface Ra ≤ 0.8 µm, outside ground”. If this is required, it must be selected separately at position 11 in the order code as a non-standard surface.

Incorporation of the option in the order code and example

Position	Description of the order code for options
13	Accessories
	/3A Adhesive ID tag, configuration of the valve acc. to 3-A standard

Position	1	2	3	4/5	6	7	8	9	10	11	12	13	14 to 19	
Code	D	E		DN 80/DN 80	S	Z	CD	L0	1	2	N	/52	/3A	0 0 0 0 0 M





Typical application and description

For transporting VARIVENT® and ECOVENT® valves with pneumatic actuator for assembly and maintenance purposes.

The transport device is screwed into the piston stem of the actuator after removal of the control and feedback system and thus permits secure transport with available lifting equipment. The transport device must be removed before commissioning.

Available nominal widths		
Metric	DN	25 – 150
Inch OD	OD	1" – 6"
Inch IPS	IPS	2" – 6"

Available valve types	
Single-seat valves with shut-off function	N, U
Single-seat valves with divert function	W, X
Mixproof valves with shut-off function	D, B, R, L, K, C
Mixproof valves with shut-off function and seat lifting	D, B, R, L, M
Mixproof valves with divert function	Y
Tank bottom valves	N, U, T

Technical data	
Material	1.4301
Connection size	M14
Article number	221-104.98



Typical application and description

For manual actuation of pneumatic VARIVENT® valves if there is a power failure as well as for actuation during maintenance and assembly work.

The emergency manual actuator attachment NOH is used for manual activation of all pneumatically operated VARIVENT® valves as well as for maintenance and assembly work on all valve types. Radial sealing valves with lifting actuator represent an exception to this. The manual emergency actuator cannot be used in these valves.

Available nominal widths		
Metric	DN	25 – 150
Inch OD	OD	1" – 6"
Inch IPS	IPS	2" – 6"

Available valve types	
Single-seat valves with shut-off function	N, U
Single-seat valves with divert function	W, X
Mixproof valves with shut-off function	D, B, R, L, K, C
Mixproof valves with shut-off function and seat lifting	D, B
Mixproof valves with divert function	Y
Tank bottom valves	N, U, T

Technical data	
Material	1.4301
Article number	221-310.74

Procedure for VARIVENT® shut-off valves type N ¹

1. Depending on the valve type, select the required table on one of the following pages.
2. The available air supply pressure indicates which rows to refer to for the actuator size.
3. Select the prevailing product pressure in order to define the required row.
4. Select a double column based on the nominal width of the valve.
5. The fail-safe position of the valve defines the precise column.
6. Select the necessary actuator size at the intersection between the row and the column.

Air supply pressure [min.]		Product pressure [max.]		Nominal widths											
				DN 25 OD 1"	DN 40/DN 50 OD 1½"/OD 2" IPS 2"	DN 65/DN 80 OD 2½"/OD 3" IPS 3"	⁴ DN 100 OD 4" IPS 4"	DN 125	DN 150 OD 6" IPS 6"						
				Spring-to-close actuators (NC) and spring-to-open actuators (NO)											
bar	PSI	bar	PSI	NC	NO	NC	NO	NC	NO	NC	⁵ NO	NC	NO	NC	NO
8	116	4	58	AA	AA	BB	BA	CD	BB	DF	DD	EG6Z	EF6A	EH6Z	EF6A
		5	72	AA	AA	BB	BA	CD	CB	DF	DD	EH6Z	EF6A	SK6Z	EG6A
		6	87	AA	AA	BB	BA	DF	CD	EG	DF	EH6Z	EF6A	SK6Z	SG6A
		7	101	AA	AA	CD	BB	DF	DD	EG	EF	SK6Z	EG6A	SM6Z	SH6A
		8	116	AA	AA	CD	BB	DF	DD	EG	EF	SK6Z	SG6A	UN6Z	SH6A
		9	130	BB	AA	CD	CB	DF	DD	EH	EG	SM6Z	SH6A	UN6Z	TK6A
7	101	4	58	AA	AA	BB	BA	CD	CB	DF	DD	EG6Z	EF6A	EH6Z	EF6A
		5	72	AA	AA	BB	BA	CD	CB	DF	DD	EH6Z	EF6A	SK6Z	SG6A
		6	87	AA	AA	BB	BA	DF	DD	EG	EF	SH6Z	EF6A	SK6Z	SG6A
		7	101	AA	AA	CD	CB	DF	DD	EG	EF	SK6Z	SG6A	SM6Z	SH6A
		8	116	AA	AA	CD	CB	DF	DD	EG	EF	SK6Z	SG6A	UN6Z	TH6A
		9	130	BB	BA	CD	CB	DF	DD	RH	RG	SM6Z	SH6A	UN6Z	TK6A
6	87	4	58	AA	AA	BB	BA	CD	CB	DF	DD	EG6Z	EF6A	SH6Z	EF6A
		5	72	AA	AA	BB	BA	CD	CB	DF	DD	SH6Z	EF6A	SK6Z	SG6A
		6	87	AA	BA	BB	BA	DF	DD	EG	EF	SH6Z	SG6A	SK6Z	SG6A
		7	101	AA	BA	CD	CB	DF	DD	EG	EF	SK6Z	SG6A	UM6Z	TH6A
		8	116	AA	BA	CD	CB	DF	DD	RG	EF	SK6Z	SG6A	UN6Z	TH6A
		9	130	BB	BA	CD	CB	DF	DD	RH	SG	UM6Z	TH6A	UN6Z	UK6A
5	72	4	58	AA	BA	BB	BA	CD	CB	EF	DD	EG6Z	TF6A	SH6Z	TF6A
		5	72	AA	BA	BB	BA	DD	DB	EF	ED	SH6Z	TF6A	TK6Z	SG6A
		6	87	AA	BA	CB	CA	EF	DD	RG	RF	SH6Z	SG6A	TK6Z	TG6A
		7	101	BA	BA	CD	CB	EF	DD	RG	RF	TK6Z	SG6A	UM6Z	UH6A
		8	116	BA	BA	CD	CB	EF	ED	RG	RF	TK6Z	TG6A	-	UH6A
		9	130	BB	BA	DD	DB	EF	ED	SH	SG	UM6Z	UH6A	-	-
² 4	⁴ 58	³ 4	58	BA	BA	CB	CA	DD	DB	EF	⁶ ED	SG6Z	TF6A	TH6Z	TF6A
		5	72	BA	BA	CB	CA	DD	DB	EF	ED	TH6Z	TF6A	UK6Z	TG6A
		6	87	BA	BA	CB	CA	EF	ED	SG	RF	TH6Z	TF6A	UK6Z	UG6A
		7	101	BA	CA	DD	DB	EF	ED	SG	SF	UK6Z	TG6A	-	-
		8	116	BA	CA	DD	DB	EF	ED	SG	SF	UK6Z	UG6A	-	-
		9	130	CB	CA	DD	DB	EF	ED	TH	TG	-	-	-	-
		10	145	CB	CA	DD	DB	SG	RF	TH	-	-	-	-	

Example:

- | | | | | | |
|------------------------------------|---------------------------------|---|-----------|-------------|--|
| 1. Valve type | VARIVENT® shut-off valve type N | } | 6. Result | Actuator ED | |
| 2. Air supply pressure | 4 bar | | | | |
| 3. Product pressure | 5 bar | | | | |
| 4. Nominal width | OD 4" | | | | |
| 5. Fail-safe position of the valve | Spring-to-open (NO) | | | | |

Procedure for VARIVENT® double-seat valves with lift function type D_L and D_C ¹

1. Depending on the valve type, select the required table on one of the following pages.
2. The available air supply pressure indicates which rows to refer to for the actuator size.
3. Select the prevailing product pressure in order to define the required row.
4. Select a double column based on the nominal width of the valve.
5. Select the necessary actuator size at the intersection between the row and the column.

Air supply pressure [min.]		Product pressure [max.]		Nominal widths											
				DN 25 OD 1"		DN 40 / DN 50 OD 1½" / OD 2" IPS 2"		DN 65 / DN 80 OD 2½" / OD 3" IPS 3"		DN 100 OD 4" IPS 4"		DN 125		DN 150 OD 6" IPS 6"	
bar	PSI	bar	PSI	Spring-to-close actuators (NC)											
				NC [actuator]	NC [lifting actuator]	NC [actuator]	NC [lifting actuator]	NC [actuator]	NC [lifting actuator]	NC [actuator]	NC [lifting actuator]	NC [actuator]	NC [lifting actuator]	NC [actuator]	NC [lifting actuator]
8	116	4	58	BA	BLB	BB	BLB	CD	CLB	DF	CLB	EG6Z	EL6	EH6Z	EL6
		5	72	BA	BLB	BB	BLB	CD	CLB	DF	CLB	EH6Z	EL6	SK6Z	EL6
		6	87	BA	BLB	BB	BLB	DF	CLB	EG	DLB	EH6Z	EL6	SK6Z	EL6
		7	101	BA	BLB	CD	BLB	DF	CLB	EG	DLB	SK6Z	EL6	SM6Z	EL6
		8	116	BA	BLB	CD	BLB	DF	CLB	EG	DLB	SK6Z	EL6	UN6Z	EL6
		9	130	BB	BLB	CD	BLB	DF	CLB	EH	ELB	SM6Z	EL6	UN6Z	EL6
7	101	4	58	BA	BLB	BB	BLB	CD	CLB	DF	DLB	EG6Z	EL6	EH6Z	EL6
		5	72	BA	BLB	BB	BLB	CD	CLB	DF	DLB	EH6Z	EL6	SK6Z	EL6
		6	87	BA	BLB	BB	BLB	DF	DLB	EG	ELB	SH6Z	EL6	SK6Z	EL6
		7	101	BA	BLB	CD	CLB	DF	DLB	EG	ELB	SK6Z	EL6	SM6Z	SL6
		8	116	BA	BLB	CD	CLB	DF	DLB	EG	ELB	SK6Z	EL6	UN6Z	SL6
		9	130	BB	BLB	CD	CLB	DF	DLB	RH	ELB	SM6Z	SL6	UN6Z	SL6
6	87	4	58	BA	BLB	BB	BLB	CD	CLB	DF	DLB	EG6Z	EL6	SH6Z	EL6
		5	72	BA	BLB	BB	BLB	CD	CLB	DF	DLB	SH6Z	EL6	SK6Z	EL6
		6	87	BA	BLB	BB	BLB	DF	DLB	EG	ELB	SH6Z	EL6	SK6Z	EL6
		7	101	BA	BLB	CD	CLB	DF	DLB	EG	ELB	SK6Z	EL6	UM6Z	SL6
		8	116	BA	BLB	CD	CLB	DF	DLB	RG	ELB	SK6Z	EL6	UN6Z	SL6
		9	130	BB	BLB	CD	CLB	DF	DLB	RH	ELB	UM6Z	SL6	UN6Z	SL6
5	72	4	58	BA	BLB	BB	BLB	CD	CLB	EF	DLB	EG6Z	EL6	SH6Z	EL6
		5	72	BA	BLB	BB	BLB	DD	CLB	EF	DLB	SH6Z	EL6	TK6Z	SL6
		6	87	BA	BLB	CD	BLB	EF	DLB	RG	ELB	SH6Z	EL6	TK6Z	SL6
		7	101	BA	BLB	CD	CLB	EF	DLB	RG	ELB	TK6Z	SLB6	UM6Z	SL6
		8	116	BA	BLB	CD	CLB	EF	DLB	RG	ELB	TK6Z	SL6	-	-
		9	130	BB	BLB	CD	CLB	EF	DLB	-	-	UK6Z	SL6	-	-
4	58	4	58	BA	BLB	CB	CLB	DD	DLB	EF	ELB	SG6Z	EL6	TH6Z	SL6
		5	72	BA	BLB	CB	CLB	DD	DLB	EF	ELB	TH6Z	SL6	UK6Z	SL6
		6	87	BA	BLB	CB	CLB	EF	ELB	-	-	TH6Z	SL6	UK6Z	SL6
		7	101	BA	BLB	-	-	EF	ELB	-	-	UK6Z	SL6	-	-
		8	116	BA	BLB	-	-	EF	ELB	-	-	UK6Z	SL6	-	-
		9	130	CB	CLB	-	-	EF	ELB	-	-	-	-	-	-

Example:

1. Valve type
2. Air supply pressure
3. Product pressure
4. Nominal width

VARIVENT® double-seat valve with lift function type D_L
 7 bar
 6 bar
 DN 65

5. Result

Actuator DF
 Lifting actuator DLB

For VARIVENT® shut-off valves type N

The standard configuration has 6 bar air supply pressure for 5 bar product pressure (see blue mark in the table). The particular product and air supply pressure must be specified

when ordering. If you do not provide any further information about the pressures when ordering, we will supply the standard configuration.

				Nominal widths											
				DN 25 OD 1"		DN 40 / DN 50 OD 1½" / OD 2" IPS 2"		DN 65 / DN 80 OD 2½" / OD 3" IPS 3"		DN 100 OD 4" IPS 4"		DN 125		DN 150 OD 6" IPS 6"	
Air supply pressure [min.]		Product pressure [max.]		Spring-to-close actuators (NC) and spring-to-open actuators (NO)											
bar	PSI	bar	PSI	NC	NO	NC	NO	NC	NO	NC	NO	NC	NO	NC	NO
8	116	4	58	AA	AA	BB	BA	CD	BB	DF	DD	EG6Z	EF6A	EH6Z	EF6A
		5	72	AA	AA	BB	BA	CD	CB	DF	DD	EH6Z	EF6A	SK6Z	EG6A
		6	87	AA	AA	BB	BA	DF	CD	EG	DF	EH6Z	EF6A	SK6Z	SG6A
		7	101	AA	AA	CD	BB	DF	DD	EG	EF	SK6Z	EG6A	SM6Z	SH6A
		8	116	AA	AA	CD	BB	DF	DD	EG	EF	SK6Z	SG6A	UN6Z	SH6A
		9	130	BB	AA	CD	CB	DF	DD	EH	EG	SM6Z	SH6A	UN6Z	TK6A
		10	145	BB	AA	CD	CB	EG	DF	EH	RG	SM6Z	SH6A	-	TK6A
7	101	4	58	AA	AA	BB	BA	CD	CB	DF	DD	EG6Z	EF6A	EH6Z	EF6A
		5	72	AA	AA	BB	BA	CD	CB	DF	DD	EH6Z	EF6A	SK6Z	SG6A
		6	87	AA	AA	BB	BA	DF	DD	EG	EF	SH6Z	EF6A	SK6Z	SG6A
		7	101	AA	AA	CD	CB	DF	DD	EG	EF	SK6Z	SG6A	SM6Z	SH6A
		8	116	AA	AA	CD	CB	DF	DD	EG	EF	SK6Z	SG6A	UN6Z	TH6A
		9	130	BB	BA	CD	CB	DF	DD	RH	RG	SM6Z	SH6A	UN6Z	TK6A
		10	145	BB	BA	CD	CB	EG	EF	RH	RG	UM6Z	TH6A	-	UK6A
6	87	4	58	AA	AA	BB	BA	CD	CB	DF	DD	EG6Z	EF6A	SH6Z	EF6A
		5	72	AA	AA	BB	BA	CD	CB	DF	DD	SH6Z	EF6A	SK6Z	SG6A
		6	87	AA	BA	BB	BA	DF	DD	EG	EF	SH6Z	SG6A	SK6Z	SG6A
		7	101	AA	BA	CD	CB	DF	DD	EG	EF	SK6Z	SG6A	UM6Z	TH6A
		8	116	AA	BA	CD	CB	DF	DD	RG	EF	SK6Z	SG6A	UN6Z	TH6A
		9	130	BB	BA	CD	CB	DF	DD	RH	SG	UM6Z	TH6A	UN6Z	UK6A
		10	145	BB	BA	CD	CB	EG	EF	RH	SG	UM6Z	TH6A	-	UK6A
5	72	4	58	AA	BA	BB	BA	CD	CB	EF	DD	EG6Z	TF6A	SH6Z	TF6A
		5	72	AA	BA	BB	BA	DD	DB	EF	ED	SH6Z	TF6A	TK6Z	SG6A
		6	87	AA	BA	CB	CA	EF	DD	RG	RF	SH6Z	SG6A	TK6Z	TG6A
		7	101	BA	BA	CD	CB	EF	DD	RG	RF	TK6Z	SG6A	UM6Z	UH6A
		8	116	BA	BA	CD	CB	EF	ED	RG	RF	TK6Z	TG6A	-	UH6A
		9	130	BB	BA	DD	DB	EF	ED	SH	SG	UM6Z	UH6A	-	-
		10	145	BB	BA	DD	DB	RG	EF	SH	TG	UM6Z	UH6A	-	-
4	58	4	58	BA	BA	CB	CA	DD	DB	EF	ED	SG6Z	TF6A	TH6Z	TF6A
		5	72	BA	BA	CB	CA	DD	DB	EF	ED	TH6Z	TF6A	UK6Z	TG6A
		6	87	BA	BA	CB	CA	EF	ED	SG	RF	TH6Z	TF6A	UK6Z	UG6A
		7	101	BA	CA	DD	DB	EF	ED	SG	SF	UK6Z	TG6A	-	-
		8	116	BA	CA	DD	DB	EF	ED	SG	SF	UK6Z	UG6A	-	-
		9	130	CB	CA	DD	DB	EF	ED	TH	TG	-	-	-	-
		10	145	CB	CA	DD	DB	SG	RF	TH	-	-	-	-	-

Actuators R..., S... and T... are made up of the actuator air/spring type S and booster cylinders as follows:

R... = actuator D + booster cylinder D

S... = actuator E + booster cylinder D

T... = actuator E + booster cylinder E

If there are different product pressures in the valve housings, this can result in different actuator sizes which cannot be found in the table. Please contact us in this case.

For a detailed description of the composition of actuator/booster cylinders, please refer to the VARIVENT® booster cylinder page on the actuator air/spring.

For ECOVENT® shut-off valves type N/ECO

The standard configuration has 6 bar air supply pressure for 5 bar product pressure (see blue mark in the table). The particular product and air supply pressure must be specified

when ordering. If you do not provide any further information about the pressures when ordering, we will supply the standard configuration.

				Nominal widths							
				DN 25 OD 1"		DN 40 / DN 50 OD 1½" / OD 2"		DN 65 / DN 80 OD 2½" / OD 3"		DN 100 OD 4"	
Air supply pressure [min.]		Product pressure [max.]		Spring-to-close actuators (NC) and spring-to-open actuators (NO)							
bar	PSI	bar	PSI	NC	NO	NC	NO	NC	NO	NC	NO
8	116	4	58	AAA	AAA	EBB	EBA	ECD	EBB	EDF	EDD
		5	72	AAA	AAA	EBB	EBA	ECD	ECB	EDF	EDD
		6	87	AAA	AAA	EBB	EBA	EDF	ECD	*	EDF
		7	101	AAA	AAA	ECD	EBB	EDF	EDD	*	*
		8	116	AAA	AAA	ECD	EBB	EDF	EDD	*	*
		9	130	EBB	AAA	ECD	ECB	EDF	EDD	*	*
		10	145	EBB	AAA	ECD	ECB	*	EDF	*	*
7	101	4	58	AAA	AAA	EBB	EBA	ECD	ECB	EDF	EDD
		5	72	AAA	AAA	EBB	EBA	ECD	ECB	EDF	EDD
		6	87	AAA	AAA	EBB	EBA	EDF	EDD	*	*
		7	101	AAA	AAA	ECD	ECB	EDF	EDD	*	*
		8	116	AAA	AAA	ECD	ECB	EDF	EDD	*	*
		9	130	EBB	EBA	ECD	ECB	EDF	EDD	*	*
		10	145	EBB	EBA	ECD	ECB	*	*	*	-
6	87	4	58	AAA	AAA	EBB	EBA	ECD	ECB	EDF	EDD
		5	72	AAA	AAA	EBB	EBA	ECD	ECB	EDF	EDD
		6	87	AAA	EBA	EBB	EBA	EDF	EDD	L+EDD	L+EDB
		7	101	AAA	EBA	ECD	ECB	EDF	EDD	L+EDD	L+EDB
		8	116	AAA	EBA	ECD	ECB	EDF	EDD	L+EDB	-
		9	130	EBB	EBA	ECD	ECB	EDF	EDD	L+EDB	-
		10	145	EBB	EBA	ECD	ECB	L+EDD	L+EDD	-	-
5	72	4	58	AAA	EBA	EBB	EBA	ECD	ECB	L+EDD	EDD
		5	72	AAA	EBA	EBB	EBA	EDD	EDB	L+EDD	L+EDB
		6	87	AAA	EBA	ECB	ECA	L+EDD	EDD	L+EDB	L+EDB
		7	101	EBA	EBA	ECD	ECB	L+EDD	EDD	L+EDB	-
		8	116	EBA	EBA	ECD	ECB	L+EDD	L+EDB	-	-
		9	130	EBB	EBA	EDD	EDB	L+EDD	L+EDB	-	-
		10	145	EBB	EBA	EDD	EDB	L+EDD	L+EDB	-	-
4	58	4	58	EBA	EBA	ECB	ECA	EDD	EDB	L+EDB	L+EDB
		5	72	EBA	EBA	ECB	ECA	EDD	EDB	L+EDB	-
		6	87	EBA	EBA	ECB	ECA	L+EDD	L+EDB	-	-
		7	101	EBA	ECA	EDD	EDB	L+EDD	L+EDB	-	-
		8	116	EBA	ECA	EDD	EDB	L+EDB	L+EDB	-	-
		9	130	ECB	ECA	EDD	EDB	L+EDB	L+EDB	-	-
		10	145	ECB	ECA	EDD	EDB	-	-	-	-

“L + actuator designation” indicates that this combination is only possible if the spring has air assistance. In this case, the actuator must be assisted by the corresponding air supply pressure (left column). The air pressure for assisting the actuator spring is allowed to be max. 6 bar (87 psi).

*On request



For VARIVENT® shut-off valves type U

The standard configuration has 6 bar air supply pressure for 5 bar product pressure (see blue mark in the table). The particular product and air supply pressure must be specified

when ordering. If you do not provide any further information about the pressures when ordering, we will supply the standard configuration.

				Nominal widths											
				DN 25 OD 1"		DN 40 / DN 50 OD 1½" / OD 2" IPS 2"		DN 65 / DN 80 OD 2½" / OD 3" IPS 3"		DN 100 OD 4" IPS 4"		DN 125		DN 150 OD 6" IPS 6"	
Air supply pressure [min.]		Product pressure [max.]		Spring-to-close actuators (NC) and spring-to-open actuators (NO)											
bar	PSI	bar	PSI	NC	NO	NC	NO	NC	NO	NC	NO	NC	NO	NC	NO
8	116	4	58	AA	AA	BB	BA	CD	BB	DF	DD	EG6Z	EF6A	EH6Z	EF6A
		5	72	AA	AA	BB	BA	CD	CB	DF	DD	EH6Z	EF6A	SK6Z	EG6A
		6	87	AA	AA	BB	BA	DF	CD	EG	DF	EH6Z	EF6A	SK6Z	SG6A
		7	101	AA	AA	CD	BB	DF	DD	EG	EF	SK6Z	EG6A	SM6Z	SH6A
		8	116	AA	AA	CD	BB	DF	DD	EG	EF	SK6Z	SG6A	UN6Z	SH6A
		9	130	BB	AA	CD	CB	DF	DD	EH	EG	SM6Z	SH6A	UN6Z	TK6A
7	101	4	58	AA	AA	BB	BA	CD	CB	DF	DD	EG6Z	EF6A	EH6Z	EF6A
		5	72	AA	AA	BB	BA	CD	CB	DF	DD	EH6Z	EF6A	SK6Z	SG6A
		6	87	AA	AA	BB	BA	DF	DD	EG	EF	SH6Z	EF6A	SK6Z	SG6A
		7	101	AA	AA	CD	CB	DF	DD	EG	EF	SK6Z	SG6A	SM6Z	SH6A
		8	116	AA	AA	CD	CB	DF	DD	EG	EF	SK6Z	SG6A	UN6Z	TH6A
		9	130	BB	BA	CD	CB	DF	DD	RH	RG	SM6Z	SH6A	UN6Z	TK6A
6	87	4	58	AA	AA	BB	BA	CD	CB	DF	DD	EG6Z	EF6A	SH6Z	EF6A
		5	72	AA	AA	BB	BA	CD	CB	DF	DD	SH6Z	EF6A	SK6Z	SG6A
		6	87	AA	BA	BB	BA	DF	DD	EG	EF	SH6Z	SG6A	SK6Z	SG6A
		7	101	AA	BA	CD	CB	DF	DD	EG	EF	SK6Z	SG6A	UM6Z	TH6A
		8	116	AA	BA	CD	CB	DF	DD	RG	EF	SK6Z	SG6A	UN6Z	TH6A
		9	130	BB	BA	CD	CB	DF	DD	RH	SG	UM6Z	TH6A	UN6Z	UK6A
5	72	4	58	AA	BA	BB	BA	CD	CB	EF	DD	EG6Z	TF6A	SH6Z	TF6A
		5	72	AA	BA	BB	BA	DD	DB	EF	ED	SH6Z	TF6A	TK6Z	SG6A
		6	87	AA	BA	CB	CA	EF	DD	RG	RF	SH6Z	SG6A	TK6Z	TG6A
		7	101	BA	BA	CD	CB	EF	DD	RG	RF	TK6Z	SG6A	UM6Z	UH6A
		8	116	BA	BA	CD	CB	EF	ED	RG	RF	TK6Z	TG6A	-	UH6A
		9	130	BB	BA	DD	DB	EF	ED	SH	SG	UM6Z	UH6A	-	-
4	58	4	58	BA	BA	CB	CA	DD	DB	EF	ED	SG6Z	TF6A	TH6Z	TF6A
		5	72	BA	BA	CB	CA	DD	DB	EF	ED	TH6Z	TF6A	UK6Z	TG6A
		6	87	BA	BA	CB	CA	EF	ED	SG	RF	TH6Z	TF6A	UK6Z	UG6A
		7	101	BA	CA	DD	DB	EF	ED	SG	SF	UK6Z	TG6A	-	-
		8	116	BA	CA	DD	DB	EF	ED	SG	SF	UK6Z	UG6A	-	-
		9	130	CB	CA	DD	DB	EF	ED	TH	TG	-	-	-	-
4	145	10	145	CB	CA	DD	DB	SG	RF	TH	-	-	-	-	

Actuators R..., S... and T... are made up of the actuator air/spring type S and booster cylinders as follows:

R... = actuator D + booster cylinder D

S... = actuator E + booster cylinder D

T... = actuator E + booster cylinder E

If there are different product pressures in the valve housings, this can result in different actuator sizes which cannot be found in the table. Please contact us in this case.

For a detailed description of the composition of actuator/booster cylinders, please refer to the VARIVENT® booster cylinder page on the actuator air/spring.

For VARIVENT® divert valves type W

The standard configuration has 6 bar air supply pressure for 5 bar product pressure (see blue mark in the table). The particular product and air supply pressure must be specified

when ordering. If you do not provide any further information about the pressures when ordering, we will supply the standard configuration.

				Nominal widths											
				DN 25 OD 1"		DN 40 / DN 50 OD 1½" / OD 2" IPS 2"		DN 65 / DN 80 OD 2½" / OD 3" IPS 3"		DN 100 OD 4" IPS 4"		DN 125		DN 150 OD 6" IPS 6"	
Air supply pressure [min.]		Product pressure [max.]		Spring-to-close actuators (NC) and spring-to-open actuators (NO)											
bar	PSI	bar	PSI	NC	NO	NC	NO	NC	NO	NC	NO	NC	NO	NC	NO
8	116	4	58	AA	AA	BB	BB	CD	CD	DF	DF	EG6Z	EG6A	SH6Z	SH6A
		5	72	AA	AA	BB	BB	CD	CD	DF	DF	SH6Z	SH6A	SK6Z	SK6A
		6	87	AA	AA	BB	BB	DF	DF	EG	EG	SH6Z	SH6A	SK6Z	SK6A
		7	101	AA	AA	CD	CD	DF	DF	EG	EG	SK6Z	SK6A	UM6Z	UM6A
		8	116	AA	AA	CD	CD	DF	DF	EG	EG	SK6Z	SK6A	UN6Z	UN6A
		9	130	BB	BB	CD	CD	DF	DF	RH	RH	UM6Z	UM6A	UN6Z	UN6A
		10	145	BB	BB	CD	CD	EG	EG	RH	RH	UM6Z	UM6A	-	-
7	101	4	58	AA	AA	BB	BB	CD	CD	DF	DF	EG6Z	EG6A	SH6Z	SH6A
		5	72	AA	AA	BB	BB	DD	DD	EF	EF	SH6Z	SH6A	SK6Z	SK6A
		6	87	AA	AA	BB	BB	DF	DF	EG	EG	SH6Z	SH6A	TK6Z	TK6A
		7	101	AA	AA	CD	CD	DF	DF	RG	RG	TK6Z	TK6A	UM6Z	UM6A
		8	116	AA	AA	CD	CD	EF	EF	RG	RG	TK6Z	TK6A	UN6Z	UN6A
		9	130	BB	BB	CD	CD	EF	EF	SH	SH	UM6Z	UM6A	UN6Z	UN6A
		10	145	BB	BB	DD	DD	EG	EG	SH	SH	UM6Z	UM6A	-	-
6	87	4	58	AA	AA	CB	CB	DD	DD	EF	EF	SG6Z	SG6A	SH6Z	SH6A
		5	72	AA	AA	CB	CB	DD	DD	EF	EF	SH6Z	SH6A	TK6Z	TK6A
		6	87	BA	BA	CB	CB	EF	EF	RG	RG	SH6Z	SH6A	TK6Z	TK6A
		7	101	BA	BA	DD	DD	EF	EF	RG	RG	TK6Z	TK6A	UM6Z	UM6A
		8	116	BA	BA	DD	DD	EF	EF	RG	RG	TK6Z	TK6A	-	-
		9	130	CB	CB	DD	DD	EF	EF	SH	SH	UM6Z	UM6A	-	-
		10	145	CB	CB	DD	DD	RG	RG	SH	SH	UM6Z	UM6A	-	-
5	72	4	58	BA	BA	CB	CB	DD	DD	EF	EF	SG6Z	SG6A	TH6Z	TH6A
		5	72	BA	BA	CB	CB	DD	DD	EF	EF	SH6Z	SH6A	UK6Z	UK6A
		6	87	BA	BA	CB	CB	EF	EF	SG	SG	TH6Z	TH6A	UK6Z	UK6A
		7	101	BA	BA	DD	DD	EF	EF	SG	SG	UK6Z	UK6A	-	-
		8	116	BA	BA	DD	DD	EF	EF	SG	SG	UK6Z	UK6A	-	-
		9	130	CB	CB	DD	DD	EF	EF	TH	TH	-	-	-	-
		10	145	CB	CB	DD	DD	SG	SG	TH	TH	-	-	-	-
4	58	4	58	BA	BA	CB	CB	DD	DD	RF	RF	TG6Z	TG6A	UH6Z	UH6A
		5	72	BA	BA	DB	DB	ED	ED	RF	RF	UH6Z	UH6A	-	-
		6	87	BA	BA	DB	DB	RF	RF	TG	TG	UH6Z	UH6A	-	-
		7	101	CA	CA	DD	DD	RF	RF	TG	TG	-	-	-	-
		8	116	CA	CA	DD	DD	RF	RF	TG	TG	-	-	-	-
		9	130	CB	CB	ED	ED	RF	RF	-	-	-	-	-	-
		10	145	DB	DB	ED	ED	TG	TG	-	-	-	-	-	-

Actuators R..., S... and T... are made up of the actuator air/spring type S and booster cylinders as follows:

R... = actuator D + booster cylinder D

S... = actuator E + booster cylinder D

T... = actuator E + booster cylinder E

If there are different product pressures in the valve housings, this can result in different actuator sizes which cannot be found in the table. Please contact us in this case.

For a detailed description of the composition of actuator/booster cylinders, please refer to the VARIVENT® booster cylinder page on the actuator air/spring.



For ECOVENT® divert valves type W/ECO

The standard configuration has 6 bar air supply pressure for 5 bar product pressure (see blue mark in the table). The particular product and air supply pressure must be specified

when ordering. If you do not provide any further information about the pressures when ordering, we will supply the standard configuration.

				Nominal widths							
				DN 25 OD 1"		DN 40 / DN 50 OD 1½" / OD 2"		DN 65 / DN 80 OD 2½" / OD 3"		DN 100 OD 4"	
Air supply pressure [min.]		Product pressure [max.]		Spring-to-close actuators (NC) and spring-to-open actuators (NO)							
bar	PSI	bar	PSI	NC	NO	NC	NO	NC	NO	NC	NO
8	116	4	58	AAA	AAA	EBB	EBB	ECD	ECD	EDF	EDF
		5	72	AAA	AAA	EBB	EBB	ECD	ECD	EDF	EDF
		6	87	AAA	AAA	EBB	EBB	EDF	EDF	*	*
		7	101	AAA	AAA	ECD	ECD	EDF	EDF	*	*
		8	116	AAA	AAA	ECD	ECD	EDF	EDF	*	*
		9	130	EBB	EBB	ECD	ECD	EDF	EDF	*	*
7	101	4	58	AAA	AAA	EBB	EBB	ECD	ECD	EDF	EDF
		5	72	AAA	AAA	EBB	EBB	EDD	EDD	*	*
		6	87	AAA	AAA	EBB	EBB	EDF	EDF	*	*
		7	101	AAA	AAA	ECD	ECD	EDF	EDF	*	*
		8	116	AAA	AAA	ECD	ECD	*	*	*	*
		9	130	EBB	EBB	ECD	ECD	*	*	*	*
6	87	4	58	AAA	AAA	ECB	ECB	EDD	EDD	L+EDD	L+EDD
		5	72	AAA	AAA	ECB	ECB	EDD	EDD	L+EDD	L+EDD
		6	87	EBA	EBA	ECB	ECB	L+EDD	L+EDD	L*EDB	L*EDB
		7	101	EBA	EBA	EDD	EDD	L+EDD	L+EDD	L+EDB	L+EDB
		8	116	EBA	EBA	EDD	EDD	L+EDD	L+EDD	-	-
		9	130	ECB	ECB	EDD	EDD	L+EDD	L+EDD	-	-
5	72	4	58	EBA	EBA	ECB	ECB	EDD	EDD	L+EDD	L+EDD
		5	72	EBA	EBA	ECB	ECB	EDD	EDD	L+EDB	L+EDB
		6	87	EBA	EBA	ECB	ECB	L+EDD	L+EDD	L+EDB	L+EDB
		7	101	EBA	EBA	EDD	EDD	L+EDD	L+EDD	-	-
		8	116	EBA	EBA	EDD	EDD	L+EDB	L+EDB	-	-
		9	130	ECB	ECB	EDD	EDD	L+EDB	L+EDB	-	-
4	58	4	58	EBA	EBA	ECB	ECB	EDD	EDD	L+EDB	L+EDB
		5	72	EBA	EBA	EDB	EDB	L+EDB	L+EDB	-	-
		6	87	EBA	EBA	EDB	EDB	L+EDB	L+EDB	-	-
		7	101	ECA	ECA	EDD	EDD	L+EDB	L+EDB	-	-
		8	116	ECA	ECA	EDD	EDD	-	-	-	-
		9	130	ECB	ECB	L+EDB	L+EDB	-	-	-	-
10	145	EDB	EDB	L+EDB	L+EDB	-	-	-	-		

"L + actuator designation" indicates that this combination is only possible if the spring has air assistance. In this case, the actuator must be assisted by the corresponding air supply pressure (left column). The air pressure for assisting the actuator spring is allowed to be max. 6 bar (87 psi).

*On request

For VARIVENT® divert valves type X

The standard configuration has 6 bar air supply pressure for 5 bar product pressure (see blue mark in the table). The particular product and air supply pressure must be specified

when ordering. If you do not provide any further information about the pressures when ordering, we will supply the standard configuration.

				Nominal widths											
				DN 25 OD 1"		DN 40 / DN 50 OD 1½" / OD 2" IPS 2"		DN 65 / DN 80 OD 2½" / OD 3" IPS 3"		DN 100 OD 4" IPS 4"		DN 125		DN 150 OD 6" IPS 6"	
Air supply pressure [min.]		Product pressure [max.]		Spring-to-close actuators (NC) and spring-to-open actuators (NO)											
bar	PSI	bar	PSI	NC	NO	NC	NO	NC	NO	NC	NO	NC	NO	NC	NO
8	116	4	58	AA	AA	BB	BB	CD	CD	DF	DF	EG6Z	EG6A	SH6Z	SH6A
		5	72	AA	AA	BB	BB	CD	CD	DF	DF	SH6Z	SH6A	SK6Z	SK6A
		6	87	AA	AA	BB	BB	DF	DF	EG	EG	SH6Z	SH6A	SK6Z	SK6A
		7	101	AA	AA	CD	CD	DF	DF	EG	EG	SK6Z	SK6A	UM6Z	UM6A
		8	116	AA	AA	CD	CD	DF	DF	EG	EG	SK6Z	SK6A	UN6Z	UN6A
		9	130	BB	BB	CD	CD	DF	DF	RH	RH	UM6Z	UM6A	UN6Z	UN6A
7	101	4	58	AA	AA	BB	BB	CD	CD	DF	DF	EG6Z	EG6A	SH6Z	SH6A
		5	72	AA	AA	BB	BB	DD	DD	EF	EF	SH6Z	SH6A	SK6Z	SK6A
		6	87	AA	AA	BB	BB	DF	DF	EG	EG	SH6Z	SH6A	TK6Z	TK6A
		7	101	AA	AA	CD	CD	DF	DF	RG	RG	TK6Z	TK6A	UM6Z	UM6A
		8	116	AA	AA	CD	CD	EF	EF	RG	RG	TK6Z	TK6A	UN6Z	UN6A
		9	130	BB	BB	CD	CD	EF	EF	SH	SH	UM6Z	UM6A	UN6Z	UN6A
6	87	4	58	AA	AA	CB	CB	DD	DD	EF	EF	SG6Z	SG6A	SH6Z	SH6A
		5	72	AA	AA	CB	CB	DD	DD	EF	EF	SH6Z	SH6A	TK6Z	TK6A
		6	87	BA	BA	CB	CB	EF	EF	RG	RG	SH6Z	SH6A	TK6Z	TK6A
		7	101	BA	BA	DD	DD	EF	EF	RG	RG	TK6Z	TK6A	UM6Z	UM6A
		8	116	BA	BA	DD	DD	EF	EF	RG	RG	TK6Z	TK6A	-	-
		9	130	CB	CB	DD	DD	EF	EF	SH	SH	UM6Z	UM6A	-	-
5	72	4	58	BA	BA	CB	CB	DD	DD	EF	EF	SG6Z	SG6A	TH6Z	TH6A
		5	72	BA	BA	CB	CB	DD	DD	EF	EF	SH6Z	SH6A	UK6Z	UK6A
		6	87	BA	BA	CB	CB	EF	EF	SG	SG	TH6Z	TH6A	UK6Z	UK6A
		7	101	BA	BA	DD	DD	EF	EF	SG	SG	UK6Z	UK6A	-	-
		8	116	BA	BA	DD	DD	EF	EF	SG	SG	UK6Z	UK6A	-	-
		9	130	CB	CB	DD	DD	EF	EF	TH	TH	-	-	-	-
4	58	4	58	BA	BA	CB	CB	DD	DD	RF	RF	TG6Z	TG6A	UH6Z	UH6A
		5	72	BA	BA	DB	DB	ED	ED	RF	RF	UH6Z	UH6A	-	-
		6	87	BA	BA	DB	DB	RF	RF	TG	TG	UH6Z	UH6A	-	-
		7	101	CA	CA	DD	DD	RF	RF	TG	TG	-	-	-	-
		8	116	CA	CA	DD	DD	RF	RF	TG	TG	-	-	-	-
		9	130	CB	CB	ED	ED	RF	RF	-	-	-	-	-	-

Actuators R..., S... and T... are made up of the actuator air/spring type S and booster cylinders as follows:

R... = actuator D + booster cylinder D

S... = actuator E + booster cylinder D

T... = actuator E + booster cylinder E

If there are different product pressures in the valve housings, this can result in different actuator sizes which cannot be found in the table. Please contact us in this case.

For a detailed description of the composition of actuator/booster cylinders, please refer to the VARIVENT® booster cylinder page on the actuator air/spring.



For VARIVENT® double-seat valves type D

The standard configuration has 6 bar air supply pressure for 5 bar product pressure (see blue mark in the table). The particular product and air supply pressure must be specified

when ordering. If you do not provide any further information about the pressures when ordering, we will supply the standard configuration.

				Nominal widths					
				DN 25 OD 1"	DN 40 / DN 50 OD 1½" / OD 2" IPS 2"	DN 65 / DN 80 OD 2½" / OD 3" IPS 3"	DN 100 OD 4" IPS 4"	DN 125	DN 150 OD 6" IPS 6"
Air supply pressure [min.]		Product pressure [max.]		Spring-to-close actuators (NC)					
bar	PSI	bar	PSI	NC	NC	NC	NC	NC	NC
8	116	4	58	AA	BB	CD	DF	EG6Z	EH6Z
		5	72	AA	BB	CD	DF	EH6Z	SK6Z
		6	87	AA	BB	DF	EG	EH6Z	SK6Z
		7	101	AA	CD	DF	EG	SK6Z	SM6Z
		8	116	AA	CD	DF	EG	SK6Z	UN6Z
		9	130	BB	CD	DF	EH	SM6Z	UN6Z
		10	145	BB	CD	EG	EH	SM6Z	-
7	101	4	58	AA	BB	CD	DF	EG6Z	EH6Z
		5	72	AA	BB	CD	DF	EH6Z	SK6Z
		6	87	AA	BB	DF	EG	SH6Z	SK6Z
		7	101	AA	CD	DF	EG	SK6Z	SM6Z
		8	116	AA	CD	DF	EG	SK6Z	UN6Z
		9	130	BB	CD	DF	RH	SM6Z	UN6Z
		10	145	BB	CD	EG	RH	UM6Z	-
6	87	4	58	AA	BB	CD	DF	EG6Z	SH6Z
		5	72	AA	BB	CD	DF	SH6Z	SK6Z
		6	87	AA	BB	DF	EG	SH6Z	SK6Z
		7	101	AA	CD	DF	EG	SK6Z	UM6Z
		8	116	AA	CD	DF	RG	SK6Z	UN6Z
		9	130	BB	CD	DF	RH	UM6Z	UN6Z
		10	145	BB	CD	EG	RH	UM6Z	-
5	72	4	58	AA	BB	CD	EF	EG6Z	SH6Z
		5	72	AA	BB	DD	EF	SH6Z	TK6Z
		6	87	AA	CB	EF	RG	SH6Z	TK6Z
		7	101	BA	CD	EF	RG	TK6Z	UM6Z
		8	116	BA	CD	EF	RG	TK6Z	-
		9	130	BB	DD	EF	SH	UM6Z	-
		10	145	BB	DD	RG	SH	UM6Z	-
4	58	4	58	BA	CB	DD	EF	SG6Z	TH6Z
		5	72	BA	CB	DD	EF	TH6Z	UK6Z
		6	87	BA	CB	EF	SG	TH6Z	UK6Z
		7	101	BA	DD	EF	SG	UK6Z	-
		8	116	BA	DD	EF	SG	UK6Z	-
		9	130	CB	DD	EF	TH	-	-
		10	145	CB	DD	SG	TH	-	-

Actuators R..., S..., T... and U... are made up of the actuator air/spring type S and booster cylinders as follows:
 R... = actuator D + booster cylinder D
 S... = actuator E + booster cylinder D
 T... = actuator E + booster cylinder E
 T...6 = actuator E...6 + booster cylinder E
 U...6 = actuator S...6 + booster cylinder E

If there are different product pressures in the valve housings, this can result in different actuator sizes which cannot be found in the table. Please contact us in this case.

For a detailed description of the composition of actuator / booster cylinders, please refer to the VARIVENT® booster cylinder page on the actuator air/spring.

For VARIVENT® double-seat valves type B

The standard configuration has 6 bar air supply pressure for 5 bar product pressure (see blue mark in the table). The particular product and air supply pressure must be specified

when ordering. If you do not provide any further information about the pressures when ordering, we will supply the standard configuration.

				Nominal widths				
				IPS 2"	DN 65 / DN 80 OD 2½" / OD 3" IPS 3"	DN 100 OD 4" IPS 4"	DN 125	DN 150 OD 6" IPS 6"
Air supply pressure [min.]		Product pressure [max.]		Spring-to-close actuators (NC)				
bar	PSI	bar	PSI	NC	NC	NC	NC	NC
8	116	4	58	BB	CD	DF	EF6Z	EG6Z
		5	72	BB	CD	DF	EF6Z	EG6Z
		6	87	BB	CD	DF	EF6Z	EG6Z
		7	101	BB	CD	DF	EF6Z	SG6Z
		8	116	BB	CD	EF	EF6Z	SG6Z
		9	130	BB	CD	EF	EF6Z	SG6Z
7	101	4	58	BB	CD	DF	EF6Z	EG6Z
		5	72	BB	CD	DF	EF6Z	SG6Z
		6	87	BB	CD	DF	EF6Z	SG6Z
		7	101	BB	CD	EF	EF6Z	SG6Z
		8	116	BB	CD	EF	EF6Z	SG6Z
		9	130	BB	DD	EF	TF6Z	SG6Z
6	87	4	58	BB	CD	EF	EF6Z	SG6Z
		5	72	BB	DD	EF	EF6Z	SG6Z
		6	87	BB	DD	EF	EF6Z	SG6Z
		7	101	BB	DD	EF	TF6Z	SG6Z
		8	116	CB	DD	EF	TF6Z	SG6Z
		9	130	CB	DD	EF	TF6Z	SG6Z
5	72	4	58	CB	DD	EF	EF6Z	SG6Z
		5	72	CB	DD	EF	TF6Z	SG6Z
		6	87	CB	DD	EF	TF6Z	SG6Z
		7	101	CB	DD	EF	TF6Z	TG6Z
		8	116	CB	DD	RF	TF6Z	TG6Z
		9	130	CB	DD	RF	TF6Z	TG6Z
4	58	4	58	CB	DD	RF	TF6Z	TG6Z
		5	72	CB	DD	RF	TF6Z	TG6Z
		6	87	CB	DD	RF	TF6Z	TG6Z
		7	101	CB	ED	RF	TF6Z	-
		8	116	DB	ED	-	TF6Z	-
		9	130	DB	ED	-	TF6Z	-
10	145	DB	ED	-	TF6Z	-		

Actuators R..., T... and U... are made up of the actuator air/spring type S and booster cylinders as follows:
 R... = actuator D + booster cylinder D
 T...6 = actuator E...6 + booster cylinder E
 U...6 = actuator S...6 + booster cylinder E

If there are different product pressures in the valve housings, this can result in different actuator sizes which cannot be found in the table. Please contact us in this case.

For a detailed description of the composition of actuator/booster cylinders, please refer to the VARIVENT® booster cylinder page on the actuator air/spring.



For VARIVENT® double-seat valves type R

The standard configuration has 6 bar air supply pressure for 5 bar product pressure (see blue mark in the table). The particular product and air supply pressure must be specified

when ordering. If you do not provide any further information about the pressures when ordering, we will supply the standard configuration.

				Nominal widths						
				DN 25 OD 1"	DN 40 / DN 50 OD 1½" / OD 2" IPS 2"	DN 65 OD 2 ½"	DN 80 OD 3" IPS 3"	DN 100 OD 4" IPS 4"	DN 125	DN 150 OD 6" IPS 6"
Air supply pressure [min.]		Product pressure [max.]		Spring-to-close actuators (NC)						
bar	PSI	bar	PSI	NC	NC	NC	NC	NC	NC	NC
8	116	4	58	CD	CD	DD	DD5	DD5	EF6Z	EF6Z
		5	72	CD	CD	DD	DD5	DD5	EF6Z	EF6Z
		6	87	CD	CD	DD	DD5	DD5	EF6Z	EF6Z
		7	101	CD	CD	DD	DD5	DD5	EF6Z	EF6Z
		8	116	CD	CD	DD	DD5	DD5	EF6Z	EF6Z
		9	130	CD	CD	DD	DD5	DD5	EF6Z	RF6Z
		10	145	CD	CD	DD	DD5	DD5	EF6Z	RF6Z
7	101	4	58	CD	CD	DD	DD5	DD5	EF6Z	EF6Z
		5	72	CD	CD	DD	DD5	DD5	EF6Z	EF6Z
		6	87	CD	CD	DD	DD5	DD5	EF6Z	EF6Z
		7	101	CD	CD	DD	DD5	DD5	EF6Z	RF6Z
		8	116	CD	CD	DD	DD5	DD5	EF6Z	RF6Z
		9	130	CD	CD	DD	DD5	ED5	RF6Z	RF6Z
		10	145	CD	CD	DD	DD5	ED5	RF6Z	RF6Z
6	87	4	58	CD	CD	DD	DD5	DD5	EF6Z	EF6Z
		5	72	CD	CD	DD	DD5	DD5	EF6Z	RF6Z
		6	87	CD	CD	DD	DD5	DD5	EF6Z	RF6Z
		7	101	CD	CD	DD	DD5	ED5	RF6Z	RF6Z
		8	116	CD	CD	DD	DD5	ED5	RF6Z	RF6Z
		9	130	CD	CD	DD	DD5	ED5	RF6Z	RF6Z
		10	145	CD	CD	DD	DD5	ED5	RF6Z	RF6Z
5	72	4	58	CD	DD	DD	DD5	DD5	RF6Z	RF6Z
		5	72	CD	DD	DD	DD5	ED5	RF6Z	RF6Z
		6	87	CD	DD	DD	DD5	ED5	RF6Z	RF6Z
		7	101	CD	DD	DD	DD5	ED5	RF6Z	RF6Z
		8	116	CD	DD	DD	DD5	ED5	RF6Z	TF6Z
		9	130	CD	DD	ED	ED5	ED5	RF6Z	TF6Z
		10	145	CD	DD	ED	ED5	ED5	RF6Z	TF6Z
4	58	4	58	DD	DD	DD	DD5	ED5	RF6Z	RF6Z
		5	72	DD	DD	DD	DD5	ED5	RF6Z	RF6Z
		6	87	DD	DD	ED	ED5	ED5	RF6Z	TF6Z
		7	101	DD	DD	ED	ED5	ED5	RF6Z	TF6Z
		8	116	DD	DD	ED	ED5	RD5	TF6Z	TF6Z
		9	130	DD	DD	ED	ED5	RD5	TF6Z	UG6Z
		10	145	DD	DD	ED	ED5	RD5	TF6Z	UG6Z

Actuators R..., T... and U... are made up of the actuator air/spring type S and booster cylinders as follows:
 R...5 = actuator D...5 + booster cylinder D
 R...6 = actuator D...6 + booster cylinder E
 T...6 = actuator E...6 + booster cylinder E
 U...6 = actuator S...6 + booster cylinder E

If there are different product pressures in the valve housings, this can result in different actuator sizes which cannot be found in the table. Please contact us in this case.

For a detailed description of the composition of actuator / booster cylinders, please refer to the VARIVENT® booster cylinder page on the actuator air/spring.

For VARIVENT® double-seat valves type K

The standard configuration has 6 bar air supply pressure for 5 bar product pressure (see blue mark in the table). The particular product and air supply pressure must be specified

when ordering. If you do not provide any further information about the pressures when ordering, we will supply the standard configuration.

				Nominal widths					
				DN 25 OD 1"	DN 40 / DN 50 OD 1½" / OD 2" IPS 2"	DN 65 / DN 80 OD 2½" / OD 3" IPS 3"	DN 100 OD 4" IPS 4"	DN 125	DN 150 OD 6" IPS 6"
Air supply pressure [min.]		Product pressure [max.]		Spring-to-close actuators (NC)					
bar	PSI	bar	PSI	NC	NC	NC	NC	NC	NC
8	116	4	58	AA	BB	CD	DF	EG6Z	EH6Z
		5	72	AA	BB	CD	DF	EH6Z	SK6Z
		6	87	AA	BB	DF	EG	EH6Z	SK6Z
		7	101	AA	CD	DF	EG	SK6Z	SM6Z
		8	116	AA	CD	DF	EG	SK6Z	UN6Z
		9	130	BB	CD	DF	EH	SM6Z	UN6Z
		10	145	BB	CD	EG	EH	SM6Z	-
7	101	4	58	AA	BB	CD	DF	EG6Z	EH6Z
		5	72	AA	BB	CD	DF	EH6Z	SK6Z
		6	87	AA	BB	DF	EG	SH6Z	SK6Z
		7	101	AA	CD	DF	EG	SK6Z	SM6Z
		8	116	AA	CD	DF	EG	SK6Z	UN6Z
		9	130	BB	CD	DF	RH	SM6Z	UN6Z
		10	145	BB	CD	EG	RH	UM6Z	-
6	87	4	58	AA	BB	CD	DF	EG6Z	SH6Z
		5	72	AA	BB	CD	DF	SH6Z	SK6Z
		6	87	AA	BB	DF	EG	SH6Z	SK6Z
		7	101	AA	CD	DF	EG	SK6Z	UM6Z
		8	116	AA	CD	DF	RG	SK6Z	UN6Z
		9	130	BB	CD	DF	RH	UM6Z	UN6Z
		10	145	BB	CD	EG	RH	UM6Z	-
5	72	4	58	AA	BB	CD	EF	EG6Z	SH6Z
		5	72	AA	BB	DD	EF	SH6Z	TK6Z
		6	87	AA	CB	EF	RG	SH6Z	TK6Z
		7	101	BA	CD	EF	RG	TK6Z	UM6Z
		8	116	BA	CD	EF	RG	TK6Z	-
		9	130	BB	DD	EF	SH	UM6Z	-
		10	145	BB	DD	RG	SH	UM6Z	-
4	58	4	58	BA	CB	DD	EF	SG6Z	TH6Z
		5	72	BA	CB	DD	EF	TH6Z	UK6Z
		6	87	BA	CB	EF	SG	TH6Z	UK6Z
		7	101	BA	DD	EF	SG	UK6Z	-
		8	116	BA	DD	EF	SG	UK6Z	-
		9	130	CB	DD	EF	TH	-	-
		10	145	CB	DD	SG	TH	-	-

Actuators R..., S..., T... and U... are made up of the actuator air/spring type S and booster cylinders as follows:
 R... = actuator D + booster cylinder D
 S... = actuator E + booster cylinder D
 T... = actuator E + booster cylinder E
 T...6 = actuator E...6 + booster cylinder E
 U...6 = actuator S...6 + booster cylinder E

If there are different product pressures in the valve housings, this can result in different actuator sizes which cannot be found in the table. Please contact us in this case.

For a detailed description of the composition of actuator / booster cylinders, please refer to the VARIVENT® booster cylinder page on the actuator air/spring.



For VARIVENT® double-seal valves type C

The standard configuration has 6 bar air supply pressure for 5 bar product pressure (see blue mark in the table). The particular product and air supply pressure must be specified

when ordering. If you do not provide any further information about the pressures when ordering, we will supply the standard configuration.

				Nominal widths					
				DN 25 OD 1"	DN 40 / DN 50 OD 1½" / OD 2" IPS 2"	DN 65 / DN 80 OD 2½" / OD 3" IPS 3"	DN 100 OD 4" IPS 4"	DN 125	DN 150 OD 6" IPS 6"
Air supply pressure [min.]		Product pressure [max.]		Spring-to-close actuators (NC)					
bar	PSI	bar	PSI	NC	NC	NC	NC	NC	NC
8	116	4	58	AA	BB	CD	DF	EG6Z	EH6Z
		5	72	AA	BB	CD	DF	EH6Z	SK6Z
		6	87	AA	BB	DF	EG	EH6Z	SK6Z
		7	101	AA	CD	DF	EG	SK6Z	SM6Z
		8	116	AA	CD	DF	EG	SK6Z	UN6Z
		9	130	BB	CD	DF	EH	SM6Z	UN6Z
		10	145	BB	CD	EG	EH	SM6Z	-
7	101	4	58	AA	BB	CD	DF	EG6Z	EH6Z
		5	72	AA	BB	CD	DF	EH6Z	SK6Z
		6	87	AA	BB	DF	EG	SH6Z	SK6Z
		7	101	AA	CD	DF	EG	SK6Z	SM6Z
		8	116	AA	CD	DF	EG	SK6Z	UN6Z
		9	130	BB	CD	DF	RH	SM6Z	UN6Z
		10	145	BB	CD	EG	RH	UM6Z	-
6	87	4	58	AA	BB	CD	DF	EG6Z	SH6Z
		5	72	AA	BB	CD	DF	SH6Z	SK6Z
		6	87	AA	BB	DF	EG	SH6Z	SK6Z
		7	101	AA	CD	DF	EG	SK6Z	UM6Z
		8	116	AA	CD	DF	RG	SK6Z	UN6Z
		9	130	BB	CD	DF	RH	UM6Z	UN6Z
		10	145	BB	CD	EG	RH	UM6Z	-
5	72	4	58	AA	BB	CD	EF	EG6Z	SH6Z
		5	72	AA	BB	DD	EF	SH6Z	TK6Z
		6	87	AA	CB	EF	RG	SH6Z	TK6Z
		7	101	BA	CD	EF	RG	TK6Z	UM6Z
		8	116	BA	CD	EF	RG	TK6Z	-
		9	130	BB	DD	EF	SH	UM6Z	-
		10	145	BB	DD	RG	SH	UM6Z	-
4	58	4	58	BA	CB	DD	EF	SG6Z	TH6Z
		5	72	BA	CB	DD	EF	TH6Z	UK6Z
		6	87	BA	CB	EF	SG	TH6Z	UK6Z
		7	101	BA	DD	EF	SG	UK6Z	-
		8	116	BA	DD	EF	SG	UK6Z	-
		9	130	CB	DD	EF	TH	-	-
		10	145	CB	DD	SG	TH	-	-

Actuators R..., S..., T... and U... are made up of the actuator air/spring type S and booster cylinders as follows:
 R... = actuator D + booster cylinder D
 S... = actuator E + booster cylinder D
 T... = actuator E + booster cylinder E
 T...6 = actuator E...6 + booster cylinder E
 U...6 = actuator S...6 + booster cylinder E

If there are different product pressures in the valve housings, this can result in different actuator sizes which cannot be found in the table. Please contact us in this case.

For a detailed description of the composition of actuator / booster cylinders, please refer to the VARIVENT® booster cylinder page on the actuator air/spring.

For VARIVENT® double-seat valves type L_H and type L_S

The standard configuration has 6 bar air supply pressure for 7 bar product pressure (see blue mark in the table). The particular product and air supply pressure must be specified

when ordering. If you do not provide any further information about the pressures when ordering, we will supply the standard configuration.

				Nominal widths		
				DN 40 / DN 50 OD 1½" / OD 2"	DN 65 / DN 80 OD 2½" / OD 3"	DN 100 OD 4"
Air supply pressure [min.]		Product pressure [max.]		Spring-to-close actuators (NC)		
bar	PSI	bar	PSI	NC	NC	NC
6	87	4	58	CD	DF	EG
		5	72	CD	DF	EG
		6	87	CD	DF	EG
		7	101	CD	DF	EG
		8	116	CD	EG	RH
		9	130	CD	EG	RH
		10	145	CD	EG	RH

Actuator R... is made up of the actuator air/spring type S and a booster cylinder as follows:

R... = actuator D + booster cylinder D

For a detailed description of the composition of actuator/booster cylinders, please refer to the VARIVENT® booster cylinder page on the actuator air/spring.



For VARIVENT® double-seat valves with lift function type D_L and type D_C

The standard configuration has 6 bar air supply pressure for 5 bar product pressure (see blue mark in the table). The particular product and air supply pressure must be specified

when ordering. If you do not provide any further information about the pressures when ordering, we will supply the standard configuration.

				Nominal widths											
				DN 25 OD 1"		DN 40 / DN 50 OD 1½" / OD 2" IPS 2"		DN 65 / DN 80 OD 2½" / OD 3" IPS 3"		DN 100 OD 4" IPS 4"		DN 125		DN 150 OD 6" IPS 6"	
Air supply pressure [min.]		Product pressure [max.]		Spring-to-close actuators (NC)											
bar	PSI	bar	PSI	NC [actuator]	NC [lifting actuator]	NC [actuator]	NC [lifting actuator]	NC [actuator]	NC [lifting actuator]	NC [actuator]	NC [lifting actuator]	NC [actuator]	NC [lifting actuator]	NC [actuator]	NC [lifting actuator]
8	116	4	58	BA	BLB	BB	BLB	CD	CLB	DF	CLB	EG6Z	EL6	EH6Z	EL6
		5	72	BA	BLB	BB	BLB	CD	CLB	DF	CLB	EH6Z	EL6	SK6Z	EL6
		6	87	BA	BLB	BB	BLB	DF	CLB	EG	DLB	EH6Z	EL6	SK6Z	EL6
		7	101	BA	BLB	CD	BLB	DF	CLB	EG	DLB	SK6Z	EL6	SM6Z	EL6
		8	116	BA	BLB	CD	BLB	DF	CLB	EG	DLB	SK6Z	EL6	UN6Z	EL6
		9	130	BB	BLB	CD	BLB	DF	CLB	EH	ELB	SM6Z	EL6	UN6Z	EL6
		10	145	BB	BLB	CD	BLB	EG	DLB	EH	ELB	SM6Z	EL6	-	-
7	101	4	58	BA	BLB	BB	BLB	CD	CLB	DF	DLB	EG6Z	EL6	EH6Z	EL6
		5	72	BA	BLB	BB	BLB	CD	CLB	DF	DLB	EH6Z	EL6	SK6Z	EL6
		6	87	BA	BLB	BB	BLB	DF	DLB	EG	ELB	SH6Z	EL6	SK6Z	EL6
		7	101	BA	BLB	CD	CLB	DF	DLB	EG	ELB	SK6Z	EL6	SM6Z	SL6
		8	116	BA	BLB	CD	CLB	DF	DLB	EG	ELB	SK6Z	EL6	UN6Z	SL6
		9	130	BB	BLB	CD	CLB	DF	DLB	RH	ELB	SM6Z	SL6	UN6Z	SL6
		10	145	BB	BLB	CD	CLB	EG	ELB	RH	ELB	UM6Z	SL6	-	-
6	87	4	58	BA	BLB	BB	BLB	CD	CLB	DF	DLB	EG6Z	EL6	SH6Z	EL6
		5	72	BA	BLB	BB	BLB	CD	CLB	DF	DLB	SH6Z	EL6	SK6Z	EL6
		6	87	BA	BLB	BB	BLB	DF	DLB	EG	ELB	SH6Z	EL6	SK6Z	EL6
		7	101	BA	BLB	CD	CLB	DF	DLB	EG	ELB	SK6Z	EL6	UM6Z	SL6
		8	116	BA	BLB	CD	CLB	DF	DLB	RG	ELB	SK6Z	EL6	UN6Z	SL6
		9	130	BB	BLB	CD	CLB	DF	DLB	RH	ELB	UM6Z	SL6	UN6Z	SL6
		10	145	BB	BLB	CD	CLB	EG	ELB	RH	ELB	UM6Z	SL6	-	-
5	72	4	58	BA	BLB	BB	BLB	CD	CLB	EF	DLB	EG6Z	EL6	SH6Z	EL6
		5	72	BA	BLB	BB	BLB	DD	CLB	EF	DLB	SH6Z	EL6	TK6Z	SL6
		6	87	BA	BLB	CD	BLB	EF	DLB	RG	ELB	SH6Z	EL6	TK6Z	SL6
		7	101	BA	BLB	CD	CLB	EF	DLB	RG	ELB	TK6Z	SLB6	UM6Z	SL6
		8	116	BA	BLB	CD	CLB	EF	DLB	RG	ELB	TK6Z	SL6	-	-
		9	130	BB	BLB	CD	CLB	EF	DLB	-	-	UK6Z	SL6	-	-
		10	145	BB	BLB	DD	CLB	RG	ELB	-	-	UM6Z	SL6	-	-
4	58	4	58	BA	BLB	CB	CLB	DD	DLB	EF	ELB	SG6Z	EL6	TH6Z	SL6
		5	72	BA	BLB	CB	CLB	DD	DLB	EF	ELB	TH6Z	SL6	UK6Z	SL6
		6	87	BA	BLB	CB	CLB	EF	ELB	-	-	TH6Z	SL6	UK6Z	SL6
		7	101	BA	BLB	-	-	EF	ELB	-	-	UK6Z	SL6	-	-
		8	116	BA	BLB	-	-	EF	ELB	-	-	UK6Z	SL6	-	-
		9	130	CB	CLB	-	-	EF	ELB	-	-	-	-	-	-
		10	145	CB	CLB	-	-	-	-	-	-	-	-	-	-

Actuators R..., T... and U... are made up of the actuator air/spring type S and booster cylinders as follows:
 R... = actuator D + booster cylinder D
 T...6 = actuator E...6 + booster cylinder E
 U...6 = actuator S...6 + booster cylinder E

If there are different product pressures in the valve housings, this can result in different actuator sizes which cannot be found in the table. Please contact us in this case.

For a detailed description of the composition of actuator/booster cylinders, please refer to the VARIVENT® booster cylinder page on the actuator air/spring.

For VARIVENT® double-seat valves with lift function type B_L and type B_C

The standard configuration has 6 bar air supply pressure for 5 bar product pressure (see blue mark in the table). The particular product and air supply pressure must be specified

when ordering. If you do not provide any further information about the pressures when ordering, we will supply the standard configuration.

				Nominal widths									
				IPS 2"		DN 65 / DN 80 OD 2½" / OD 3" IPS 3"		DN 100 OD 4" IPS 4"		DN 125		DN 150 OD 6" IPS 6"	
Air supply pressure [min.]		Product pressure [max.]		Spring-to-close actuators (NC)									
bar	PSI	bar	PSI	NC [actuator]	NC [lifting actuator]	NC [actuator]	NC [lifting actuator]	NC [actuator]	NC [lifting actuator]	NC [actuator]	NC [lifting actuator]	NC [actuator]	NC [lifting actuator]
8	116	4	58	BB	BLB	CD	CLB	DF	CLB	EF6Z	EL6	EG6Z	EL6
		5	72	BB	BLB	CD	CLB	DF	CLB	EF6Z	EL6	EG6Z	EL6
		6	87	BB	BLB	CD	CLB	DF	CLB	EF6Z	EL6	EG6Z	EL6
		7	101	BB	BLB	CD	CLB	DF	DLB	EF6Z	EL6	SG6Z	EL6
		8	116	BB	BLB	CD	CLB	EF	DLB	EF6Z	EL6	SG6Z	EL6
		9	130	BB	BLB	CD	CLB	EF	DLB	EF6Z	EL6	SG6Z	EL6
		10	145	BB	BLB	DD	CLB	EF	DLB	EF6Z	EL6	SG6Z	SL6
7	101	4	58	BB	BLB	CD	CLB	DF	DLB	EF6Z	EL6	EG6Z	EL6
		5	72	BB	BLB	CD	CLB	DF	DLB	EF6Z	EL6	EG6Z	EL6
		6	87	BB	BLB	CD	CLB	EF	DLB	EF6Z	EL6	SG6Z	EL6
		7	101	BB	BLB	CD	CLB	EF	DLB	EF6Z	EL6	SG6Z	EL6
		8	116	BB	BLB	DD	CLB	EF	DLB	EF6Z	EL6	SG6Z	EL6
		9	130	BB	BLB	DD	CLB	EF	DLB	TF6Z	EL6	SG6Z	EL6
		10	145	CB	BLB	DD	CLB	EF	DLB	TF6Z	EL6	SG6Z	SL6
6	87	4	58	BB	BLB	CD	CLB	EF	DLB	EF6Z	EL6	SG6Z	EL6
		5	72	BB	BLB	DD	CLB	EF	DLB	EF6Z	EL6	SG6Z	EL6
		6	87	BB	BLB	DD	CLB	EF	DLB	EF6Z	EL6	SG6Z	EL6
		7	101	BB	BLB	DD	CLB	EF	DLB	TF6Z	EL6	SG6Z	EL6
		8	116	CB	BLB	DD	CLB	EF	DLB	TF6Z	EL6	SG6Z	EL6
		9	130	CB	BLB	DD	CLB	EF	ELB	TF6Z	EL6	SG6Z	SL6
		10	145	CB	BLB	DD	DLB	EF	ELB	TF6Z	SL6	TF6Z	SL6
5	72	4	58	CB	BLB	DD	CLB	EF	DLB	EF6Z	EL6	SG6Z	EL6
		5	72	CB	BLB	DD	CLB	EF	DLB	EF6Z	EL6	SG6Z	EL6
		6	87	CB	BLB	DD	CLB	EF	DLB	EF6Z	EL6	SG6Z	SL6
		7	101	CB	BLB	DD	CLB	EF	DLB	EF6Z	EL6	TF6Z	SL6
		8	116	CB	BLB	DD	DLB	RF	ELB	TF6Z	SL6	TF6Z	SL6
		9	130	CB	CLB	DD	DLB	RF	ELB	TF6Z	SL6	TF6Z	SL6
		10	145	CB	CLB	ED	DLB	RF	ELB	TF6Z	SL6	-	-

Actuators R... and T... are made up of the actuator air/spring type S and booster cylinders as follows:
 R... = actuator D + booster cylinder D
 T...6 = actuator E...6 + booster cylinder E

If there are different product pressures in the valve housings, this can result in different actuator sizes which cannot be found in the table. Please contact us in this case.

For a detailed description of the composition of actuator/booster cylinders, please refer to the VARIVENT® booster cylinder page on the actuator air/spring.



For VARIVENT® double-seat valves with lift function type R_L and type R_C

The standard configuration has 6 bar air supply pressure for 10 bar product pressure (see blue mark in the table). The particular product and air supply pressure must be specified

when ordering. If you do not provide any further information about the pressures when ordering, we will supply the standard configuration.

				Nominal widths							
				DN 25 OD 1"		DN 40 / DN 50 OD 1½" / OD 2" IPS 2"		DN 65 OD 2½"		DN 80 OD 3" IPS 3"	
Air supply pressure [min.]		Product pressure [max.]		Spring-to-close actuators (NC)							
bar	PSI	bar	PSI	NC [actuator]	NC [lifting actuator]	NC [actuator]	NC [lifting actuator]	NC [actuator]	NC [lifting actuator]	NC [actuator]	NC [lifting actuator]
8	116	4	58	BD	BLR	BD	BLR	BD	CLR	BD5	CLR5
		5	72	BD	BLR	BD	BLR	BD	CLR	BD5	CLR5
		6	87	BD	BLR	BD	BLR	BD	CLR	BD5	CLR5
		7	101	BD	BLR	BD	BLR	BD	CLR	BD5	CLR5
		8	116	BD	BLR	BD	BLR	BD	CLR	BD5	CLR5
		9	130	BD	BLR	BD	BLR	BD	CLR	BD5	CLR5
		10	145	BD	BLR	BD	BLR	BD	CLR	BD5	CLR5
7	101	4	58	BD	BLR	BD	BLR	BD	CLR	BD5	CLR5
		5	72	BD	BLR	BD	BLR	BD	CLR	BD5	CLR5
		6	87	BD	BLR	BD	BLR	BD	CLR	BD5	CLR5
		7	101	BD	BLR	BD	BLR	BD	CLR	BD5	CLR5
		8	116	BD	BLR	BD	BLR	BD	CLR	BD5	CLR5
		10	145	BD	BLR	BD	BLR	BD	CLR	BD5	CLR5
6	87	4	58	BD	BLR	BD	BLR	BD	CLR	BD5	CLR5
		5	72	BD	BLR	BD	BLR	BD	CLR	BD5	CLR5
		6	87	BD	BLR	BD	BLR	BD	CLR	BD5	CLR5
		7	101	BD	BLR	BD	BLR	BD	CLR	BD5	CLR5
		8	116	BD	BLR	BD	BLR	BD	CLR	BD5	CLR5
		9	130	BD	BLR	BD	BLR	BD	CLR	BD5	CLR5
		10	145	BD	BLR	BD	BLR	BD	CLR	BD5	CLR5
5	72	4	58	BD	BLR	BD	BLR	BD	CLR	BD5	CLR5
		5	72	BD	BLR	BD	BLR	BD	CLR	BD5	CLR5
		6	87	BD	BLR	BD	BLR	BD	CLR	BD5	CLR5
		7	101	BD	BLR	BD	BLR	BD	CLR	BD5	CLR5
		8	116	BD	BLR	BD	BLR	BD	DLR	BD5	DLR5
		9	130	BD	BLR	BD	CLR	BD	DLR	BD5	DLR5
		10	145	BD	BLR	BD	CLR	BD	DLR	BD5	DLR5

If there are different product pressures in the valve housings, this can result in different actuator sizes which cannot be found in the table. Please contact us in this case.

Nominal widths									
DN 100 OD 4" IPS 4"		DN 125		DN 150 OD 6" IPS 6"					
Spring-to-close actuators (NC)						Air supply pressure [min.]		Product pressure [max.]	
NC [actuator]	NC [lifting actuator]	NC [actuator]	NC [lifting actuator]	NC [actuator]	NC [lifting actuator]	bar	PSI	bar	PSI
BD5	DLR5	DF6Z	ELR6	DF6Z	ELR6	4	58	8	116
BD5	DLR5	DF6Z	ELR6	DF6Z	ELR6	5	72		
BD5	DLR5	DF6Z	ELR6	DF6Z	ELR6	6	87		
BD5	DLR5	DF6Z	ELR6	DF6Z	ELR6	7	101		
BD5	DLR5	DF6Z	ELR6	DF6Z	ELR6	8	116		
BD5	DLR5	DF6Z	ELR6	DF6Z	ELR6	9	130		
BD5	DLR5	DF6Z	ELR6	DF6Z	ELR6	10	145		
BD5	DLR5	DF6Z	ELR6	DF6Z	ELR6	4	58	7	101
BD5	DLR5	DF6Z	ELR6	DF6Z	ELR6	5	72		
BD5	DLR5	DF6Z	ELR6	DF6Z	ELR6	6	87		
BD5	DLR5	DF6Z	ELR6	DF6Z	ELR6	7	101		
BD5	DLR5	DF6Z	ELR6	DF6Z	ELR6	8	116		
BD5	DLR5	DF6Z	ELR6	DF6Z	ELR6	9	130		
BD5	DLR5	DF6Z	ELR6	DF6Z	SLR6	10	145		
BD5	DLR5	DF6Z	ELR6	DF6Z	ELR6	4	58	6	87
BD5	DLR5	DF6Z	ELR6	DF6Z	ELR6	5	72		
BD5	DLR5	DF6Z	ELR6	DF6Z	ELR6	6	87		
BD5	DLR5	DF6Z	ELR6	DF6Z	ELR6	7	101		
BD5	DLR5	DF6Z	ELR6	DF6Z	SLR6	8	116		
BD5	DLR5	DF6Z	ELR6	DF6Z	SRL6	9	130		
BD5	DLR5	DF6Z	ELR6	DF6Z	SLR6	10	145		
BD5	DLR5	DF6Z	ELR6	DF6Z	ELR6	4	58	5	72
BD5	DLR5	DF6Z	ELR6	DF6Z	ELR6	5	72		
BD5	DLR5	DF6Z	ELR6	DF6Z	ELR6	6	87		
BD5	DLR5	DF6Z	ELR6	DF6Z	SLR6	7	101		
BD5	ELR5	DF6Z	ELR6	DF6Z	SLR6	8	116		
BD5	ELR5	DF6Z	SLR6	DF6Z	SLR6	9	130		
BD5	ELR5	DF6Z	SLR6	DF6Z	SLR6	10	145		

For VARIVENT® double-seat valves with lift function type L_HL, type L_HC, type L_SL and type L_SC

The standard configuration has 6 bar air supply pressure for 7 bar product pressure (see blue mark in the table). The particular product and air supply pressure must be specified

when ordering. If you do not provide any further information about the pressures when ordering, we will supply the standard configuration.

				Nominal widths					
				DN 40 / DN 50 OD 1½" / OD 2"		DN 65 / DN 80 OD 2½" / OD 3"		DN 100 OD 4"	
Air supply pressure [min.]		Product pressure [max.]		Spring-to-close actuators (NC)					
bar	PSI	bar	PSI	NC [actuator]	NC [lifting actuator]	NC [actuator]	NC [lifting actuator]	NC [actuator]	NC [lifting actuator]
6	87	4	58	BD	BLRN50	CF	CLT	DG	DLRN
		5	72	BD	BLRN50	CF	CLT	DG	DLRN
		6	87	BD	BLRN50	CF	CLT	DG	DLRN
		7	101	BD	BLRN50	CF	CLT	DG	DLRN
		8	116	CF	BLRN50	DG	CLT	DH	DLRN
		9	130	CF	BLRN50	DG	CLT	DH	DLRN
		10	145	CF	BLRN50	DG	CLT	DH	DLRN

For VARIVENT® double-seat divert valves type Y

The standard configuration has 6 bar air supply pressure for 5 bar product pressure (see blue mark in the table). The particular product and air supply pressure must be specified

when ordering. If you do not provide any further information about the pressures when ordering, we will supply the standard configuration.

				Nominal widths					
				DN 25 OD 1"	DN 40 / DN 50 OD 1½" / OD 2" IPS 2"	DN 65 / DN 80 OD 2½" / OD 3" IPS 3"	DN 100 OD 4" IPS 4"	DN 125	DN 150 OD 6" IPS 6"
Air supply pressure [min.]		Product pressure [max.]		Spring-to-close actuators (NC)					
bar	PSI	bar	PSI	NC	NC	NC	NC	NC	NC
8	116	4	58	AA	BB	CD	DF	EG6Z	SH6Z
		5	72	AA	BB	CD	DF	SH6Z	SK6Z
		6	87	AA	BB	DF	EG	SH6Z	SK6Z
		7	101	AA	CD	DF	EG	SK6Z	UM6Z
		8	116	AA	CD	DF	EG	SK6Z	UN6Z
		9	130	BB	CD	DF	RH	UM6Z	UN6Z
		10	145	BB	CD	EG	RH	UM6Z	-
7	101	4	58	AA	BB	CD	DF	EG6Z	SH6Z
		5	72	AA	BB	DD	EF	SH6Z	SK6Z
		6	87	AA	BB	DF	EG	SH6Z	TK6Z
		7	101	AA	CD	DF	RG	TK6Z	UM6Z
		8	116	AA	CD	EF	RG	TK6Z	UN6Z
		9	130	BB	CD	EF	SH	UM6Z	UN6Z
		10	145	BB	DD	EG	SH	UM6Z	-
6	87	4	58	AA	CB	DD	EF	SG6Z	SH6Z
		5	72	AA	CB	DD	EF	SH6Z	TK6Z
		6	87	BA	CB	CB	EF	SH6Z	TK6Z
		7	101	BA	DD	DD	EF	RG	TK6Z
		8	116	BA	DD	DD	EF	RG	TK6Z
		9	130	CB	DD	DD	EF	SH	UM6Z
		10	145	CB	DD	DD	RG	SH	UM6Z
5	72	4	58	BA	CB	DD	EF	SG6Z	TH6Z
		5	72	BA	CB	DD	EF	SH6Z	UK6Z
		6	87	BA	CB	DD	EF	SG	TH6Z
		7	101	BA	DD	DD	EF	SG	UK6Z
		8	116	BA	DD	DD	EF	SG	UK6Z
		9	130	CB	DD	DD	EF	TH	-
		10	145	CB	DD	DD	SG	TH	-
4	58	4	58	BA	CB	DD	RF	TG6Z	UH6Z
		5	72	BA	DB	ED	RF	UH6Z	-
		6	87	BA	DB	ED	RF	TG	UH6Z
		7	101	CA	DD	DD	RF	TG	-
		8	116	CA	DD	DD	RF	TG	-
		9	130	CB	ED	ED	RF	-	-
		10	145	DB	ED	ED	TG	-	-

Actuators R..., S... and T... are made up of the actuator air/spring type S and booster cylinders as follows:

- R... = actuator D + booster cylinder D
- S... = actuator E + booster cylinder D
- T... = actuator E + booster cylinder E

If there are different product pressures in the valve housings, this can result in different actuator sizes which cannot be found in the table. Please contact us in this case.

For a detailed description of the composition of actuator/booster cylinders, please refer to the VARIVENT® booster cylinder page on the actuator air/spring.



For VARIVENT® double-seat divert valves with lift function type Y_L and type Y_C

The standard configuration has 6 bar air supply pressure for 5 bar product pressure (see blue mark in the table). The particular product and air supply pressure must be specified

when ordering. If you do not provide any further information about the pressures when ordering, we will supply the standard configuration.

				Nominal widths											
				DN 25 OD 1"		DN 40 / DN 50 OD 1½" / OD 2" IPS 2"		DN 65 / DN 80 OD 2½" / OD 3" IPS 3"		DN 100 OD 4" IPS 4"		DN 125		DN 150 OD 6" IPS 6"	
Air supply pressure [min.]		Product pressure [max.]		Spring-to-close actuators (NC)											
bar	PSI	bar	PSI	NC [actuator]	NC [lifting actuator]	NC [actuator]	NC [lifting actuator]	NC [actuator]	NC [lifting actuator]	NC [actuator]	NC [lifting actuator]	NC [actuator]	NC [lifting actuator]	NC [actuator]	NC [lifting actuator]
8	116	4	58	BA	BLB	BB	BLB	CD	CLB	DF	CLB	EG6Z	EL6	SH6Z	EL6
		5	72	BA	BLB	BB	BLB	CD	CLB	DF	CLB	SH6Z	EL6	SK6Z	EL6
		6	87	BA	BLB	BB	BLB	DF	CLB	EG	DLB	SH6Z	EL6	SK6Z	EL6
		7	101	BA	BLB	CD	BLB	DF	CLB	EG	DLB	SK6Z	EL6	UM6Z	EL6
		8	116	BA	BLB	CD	BLB	DF	CLB	EG	DLB	SK6Z	EL6	UN6Z	EL6
		9	130	BB	BLB	CD	BLB	DF	CLB	RH	ELB	UM6Z	EL6	UN6Z	EL6
		10	145	BB	BLB	CD	BLB	EG	DLB	RH	ELB	UM6Z	EL6	-	-
7	101	4	58	BA	BLB	BB	BLB	CD	CLB	DF	DLB	EG6Z	EL6	SH6Z	EL6
		5	72	BA	BLB	BB	BLB	DD	CLB	EF	DLB	SH6Z	EL6	SK6Z	EL6
		6	87	BA	BLB	BB	BLB	DF	DLB	EG	ELB	SH6Z	EL6	TK6Z	EL6
		7	101	BA	BLB	CD	CLB	DF	DLB	RG	ELB	TK6Z	EL6	UM6Z	SL6
		8	116	BA	BLB	CD	CLB	EF	DLB	RG	ELB	TK6Z	EL6	UN6Z	SL6
		9	130	BB	BLB	CD	CLB	EF	DLB	SH	ELB	UM6Z	SL6	UN6Z	SL6
		10	145	BB	BLB	DD	CLB	EG	ELB	SH	ELB	UM6Z	SL6	-	-
6	87	4	58	BA	BLB	CB	BLB	DD	CLB	EF	DLB	SG6Z	EL6	SH6Z	EL6
		5	72	BA	BLB	CB	BLB	DD	CLB	EF	DLB	SH6Z	EL6	TK6Z	EL6
		6	87	BA	BLB	CB	BLB	EF	DLB	RG	ELB	SH6Z	EL6	TK6Z	EL6
		7	101	BA	BLB	DD	CLB	EF	DLB	RG	ELB	TK6Z	EL6	UM6Z	SL6
		8	116	BA	BLB	DD	CLB	EF	DLB	RG	ELB	TK6Z	EL6	-	-
		9	130	CB	BLB	DD	CLB	EF	DLB	SH	ELB	UM6Z	SL6	-	-
		10	145	CB	BLB	DD	CLB	RG	ELB	SH	ELB	UM6Z	SL6	-	-
5	72	4	58	BA	BLB	CB	BLB	DD	CLB	EF	DLB	SG6Z	EL6	TH6Z	EL6
		5	72	BA	BLB	CB	BLB	DD	CLB	EF	DLB	SH6Z	EL6	UK6Z	SL6
		6	87	BA	BLB	CB	BLB	EF	DLB	SG	ELB	TH6Z	EL6	UK6Z	SL6
		7	101	BA	BLB	DD	CLB	EF	DLB	SG	ELB	UK6Z	SL6	-	-
		8	116	BA	BLB	DD	CLB	EF	DLB	SG	ELB	UK6Z	SL6	-	-
		9	130	CB	BLB	DD	CLB	EF	DLB	-	-	-	-	-	-
		10	145	CB	BLB	DD	CLB	SG	ELB	-	-	-	-	-	-
4	58	4	58	BA	BLB	CB	CLB	DD	DLB	RF	ELB	TG6Z	EL6	UH6Z	SL6
		5	72	BA	BLB	DB	CLB	ED	DLB	RF	ELB	UH6Z	SL6	-	-
		6	87	BA	BLB	DB	CLB	RF	ELB	-	-	UH6Z	SL6	-	-
		7	101	CA	BLB	-	-	RF	ELB	-	-	-	-	-	-
		8	116	CA	BLB	-	-	RF	ELB	-	-	-	-	-	-
		9	130	CB	CLB	-	-	RF	ELB	-	-	-	-	-	-
		10	145	DB	CLB	-	-	-	-	-	-	-	-	-	-

Actuators R..., S..., T... and U... are made up of the actuator air/spring type S and booster cylinders as follows:
 R... = actuator D + booster cylinder D
 S... = actuator E + booster cylinder D
 T...6 = actuator E...6 + booster cylinder E
 U...6 = actuator S...6 + booster cylinder E

If there are different product pressures in the valve housings, this can result in different actuator sizes which cannot be found in the table. Please contact us in this case.

For a detailed description of the composition of actuator / booster cylinders, please refer to the VARIVENT® booster cylinder page on the actuator air/spring.

For VARIVENT® double-seat bottom valves type T_R

The standard configuration has 6 bar air supply pressure for 5 bar product pressure (see blue mark in the table). The particular product and air supply pressure must be specified

when ordering. If you do not provide any further information about the pressures when ordering, we will supply the standard configuration.

				Nominal widths							
				DN 40 OD 1½"	DN 50 OD 2" IPS 2"	DN 65 OD 2½"	DN 80 OD 3" IPS 3"	DN 100 OD 4" IPS 4"	DN 125	DN 150 OD 6" IPS 6"	
Air supply pressure [min.]		Product pressure [max.]		Spring-to-close actuators (NC)							
bar	PSI	bar	PSI	NC	NC	NC	NC	NC	NC	NC	
6	87	4	58	CD	CD	DF	DF5	EG5	SH6Z	SK6Z	
		5	72	CD	CD	DF	DF5	EG5	SH6Z	SK6Z	
		6	87	-	-	-	-	-	-	-	-
		7	101	-	-	-	-	-	-	-	-
		8	116	-	-	-	-	-	-	-	-
		9	130	-	-	-	-	-	-	-	-
		10	145	-	-	-	-	-	-	-	-
5	72	4	58	CD	CD	DF	DF5	EG5	SH6Z	SK6Z	
		5	72	CD	CD	DF	DF5	EG5	SH6Z	SK6Z	
		6	87	-	-	-	-	-	-	-	-
		7	101	-	-	-	-	-	-	-	-
		8	116	-	-	-	-	-	-	-	-
		9	130	-	-	-	-	-	-	-	-
		10	145	-	-	-	-	-	-	-	-



For VARIVENT® double-seat bottom valves with lift function type T_RL and type T_RC

The standard configuration has 6 bar air supply pressure for 5 bar product pressure (see blue mark in the table). The particular product and air supply pressure must be specified

when ordering. If you do not provide any further information about the pressures when ordering, we will supply the standard configuration.

				Nominal widths												
				DN 25* / DN 40 / DN 50 OD 1"*/ OD 2 1/2" / OD 2" IPS 2	DN 65 OD 2 1/2"	DN 80 OD 3" IPS 3"	DN 100 OD 4" IPS 4"	DN 125	DN 150 OD 6" IPS 6"							
Air supply pressure [min.]		Product pressure [max.]		Spring-to-close actuators (NC)												
bar	PSI	bar	PSI	NC [actuator]	NC [lifting actuator]	NC [actuator]	NC [lifting actuator]	NC [actuator]	NC [lifting actuator]	NC [actuator]	NC [lifting actuator]	NC [actuator]	NC [lifting actuator]	NC [actuator]	NC [lifting actuator]	
6	87	4	58	BD	BLRN**	CF	CLT	DF5	DLT5	DG5	DLT5	EH6Z	ELR6	EK6Z	ELR6	
		5	72	BD	BLRN**	CF	CLT	DF5	DLT5	DG5	DLT5	EH6Z	ELR6	EK6Z	ELR6	
		6	87	-	-	-	-	-	-	-	-	-	-	-	-	-
		7	101	-	-	-	-	-	-	-	-	-	-	-	-	-
		8	116	-	-	-	-	-	-	-	-	-	-	-	-	-
		9	130	-	-	-	-	-	-	-	-	-	-	-	-	-
		10	145	-	-	-	-	-	-	-	-	-	-	-	-	-
5	72	4	58	BD	BLR	CF	CLT	DF5	DLT5	DG5	DLT5	EH6Z	ELR6	EK6Z	ELR6	
		5	72	BD	BLR	CF	CLT	DF5	DLT5	DG5	DLT5	EH6Z	ELR6	EK6Z	ELR6	
		6	87	-	-	-	-	-	-	-	-	-	-	-	-	-
		7	101	-	-	-	-	-	-	-	-	-	-	-	-	-
		8	116	-	-	-	-	-	-	-	-	-	-	-	-	-
		9	130	-	-	-	-	-	-	-	-	-	-	-	-	-
		10	145	-	-	-	-	-	-	-	-	-	-	-	-	-

* The nominal widths DN 25 and OD 1" are available as double-seat bottom valve with lift function without spray cleaning.

** The lifting actuator also has a supplement, depending on the nominal width:

- DN 25/OD 1": BLRN25
- DN 40/OD 1 1/2": BLRN40
- DN 50/OD 2"/IPS 2": BLRN50

Description and order code

A valve insert consists of: valve disc, lantern, seal disc, bearing disc incl. seal, V-rings, O-rings and, where appropriate, double disc, leakage housing and cleaning connection in the lantern.

Position	Description of the order code		
1	Valve type		
	N Shut-off valve	B Double-seat valve	
	U Shut-off valve	R Double-seat valve	
	W Divert valve	C Double-seat valve	
	X Divert valve	K Double-seat valve	
	D Double-seat valve	T Tank bottom valve	
2	Supplement to the valve type		
	- Without	F Control cone equal percentage	
	V Long-stroke	J Control cone linear	
	L With lifting actuator and spray cleaning	R Radial sealing	
C With lifting actuator without spray cleaning			
3/4	Nominal width (upper housing / lower housing)		
	DN 25	OD 1"	
	DN 40	OD 1 ½"	
	DN 50	OD 2"	IPS 2"
	DN 65	OD 2 ½"	
	DN 80	OD 3"	IPS 3"
	DN 100	OD 4"	IPS 4"
	DN 125		
DN 150	OD 6"	IPS 6"	
5	Feedback in the lantern		
	0 Without		
	7 Prepared for 2x NI M12x1		
6	Seal material in contact with the product		
	1 EPDM (FDA)		
	2 FKM (FDA)		
	3 HNBR (FDA); (up to DN 100, OD 4")		
7	Sterile lock		
	24 Sterile lock complete		
8	Limit stop		
	- Without		
	20 Opening		
21 Closing			
9	Leakage pipe		
	K1 Straight		
	K2 90° curved		
10	Material wetted parts		
	2 1.4404 (AISI 316L)		

The code is composed as following, depending on the chosen configuration:

Position	1	2	3/4	5	6	7	8	9	10
Code			/						2











VARIVENT® housing combinations make it possible to adapt or modify existing valve systems in process systems without changing the original plant concept. During the planning stage, later system extensions can already be provided for by including housing combinations.

The ball-shaped VARIVENT® housings offer best flow profiles without flow separations, which means optimum cleaning properties. The housings, free from dead space, exactly fit in height the diameter of the connection pipes, eliminating domes and sumps and their negative consequences, e.g. damage by oxidation. VARIVENT® housing connections are available in both fixed and separable versions.

Position	Description of the order code	Available for valve type						
		N	U	D	B	R	K	T
1	Valve type							
	N VARIVENT® shut-off valve							
	U VARIVENT® shut-off valve							
	D VARIVENT® double-seat valve							
	B VARIVENT® double-seat valve with balancer							
	R VARIVENT® radial sealing double-seat valve							
	K VARIVENT® double-seat valve							
T VARIVENT® tank bottom valves								
2	Housing combinations							
	L T	•					•	•
	F* D* F* D*		•					•
	A B C E	•	•	•	•	•	•	
3	Supplement to the valve type							
	- without							
4/5	Nominal width (upper housing / lower housing)							
	DN 25, DN 40, DN 50	•	•	•		•	•	•
	DN 65, DN 80, DN 100, DN 125, DN 150	•	•	•	•	•	•	•
	OD 1", OD 1 ½", OD 2"	•	•	•		•	•	•
	OD 2 ½", OD 3", OD 4", OD 6"	•	•	•	•	•	•	•
	IPS 2", IPS 3", IPS 4", IPS 6"	•	•	•	•	•	•	•
6	Blanking plates							
	0 No blanking plate	•	•	•	•	•	•	•
	1 One blanking plate	•	•	•	•	•	•	•
	2 Two blanking plates	•	•	•	•	•	•	•

* With housing connection flange U

Position	Description of the order code									Available for valve type							
	Valve seat version		A	B	Housing combination				F	D	N	U	D	B	R	K	T
7	L0	Loose seat ring/ Clamp connection	√	√	√	√	√	√	√**	√**	•	•	•***	•***	•***	•	•****
	V0	Fixed vertical port					√	√			•					•	
	V1	Welded seat ring/ Port orientation 90°									•	•	•	•	•	•	•
	V2	Welded seat ring/ Port orientation 180°									•	•	•	•	•	•	•
	V3	Welded seat ring/ Port orientation 270°									•	•	•	•	•	•	•
8	Seal material																
	1	EPDM (FDA)									•	•	•	•	•	•	•
	2	FKM (FDA)									•	•	•	•	•	•	•
	3	HNBR (FDA); (up to DN 100, OD 4")									•	•	•	•	•	•	•
9	Surface quality of the housing																
	1*****	Inside Ra ≤ 1.2 µm, outside matte blasted									•	•	•	•	•	•	•
	2*****	Inside Ra ≤ 0.8 µm, outside matte blasted									•	•	•	•	•	•	•
	3	Inside Ra ≤ 0.8 µm, outside ground									•	•	•	•	•	•	•
	4	Inside Ra ≤ 0.4 µm, outside matte blasted									•	•	•	•	•	•	•
	6	Inside Ra ≤ 0.5 µm, outside matte blasted									•	•	•	•	•	•	•
	7	Inside Ra ≤ 0,5 µm, outside ground									•	•	•	•	•	•	•
10	Connection fittings																
	N	Welding end									•	•	•	•	•	•	•
	J	With connection fitting (please specify separately in each case)									•	•	•	•	•	•	•
	TK	VARIVENT® flange connection complete, groove flange on housing									•	•	•	•	•	•	•
	TN	VARIVENT® groove flange cpl., incl. O-ring and connecting parts									•	•	•	•	•	•	•
	TF	VARIVENT® smooth flange									•	•	•	•	•	•	•
	GK	Pipe fitting S complete, male end on housing									•	•	•	•	•	•	•
	KO	Liner including groove nut SD									•	•	•	•	•	•	•
	GO	Male end SC including sealing ring G									•	•	•	•	•	•	•
	ASK	Hygienic flange connection complete, groove flange on housing									•	•	•	•	•	•	•
	NFK	Hygienic-groove flange complete, incl. O-ring and connecting parts									•	•	•	•	•	•	•
BFK	Hygienic flange									•	•	•	•	•	•	•	
CO	Clamp connection									•	•	•	•	•	•	•	

** Housing combinations F and D are available for type U only.

*** For types D, B, and R only the housing combinations A, B, C and E with loose seat ring are available.

**** For type T only the housing combinations I, T, F and D with loose seat ring are available.

***** The standard surface for DN / OD corresponds to Ra ≤ 0.8 µm.

***** The standard surface for IPS corresponds to Ra ≤ 1.2 µm.





The code is composed as following, depending on the chosen configuration:

Position	1	2	3	4/5	6	7	8	9	10
Code			-	/					

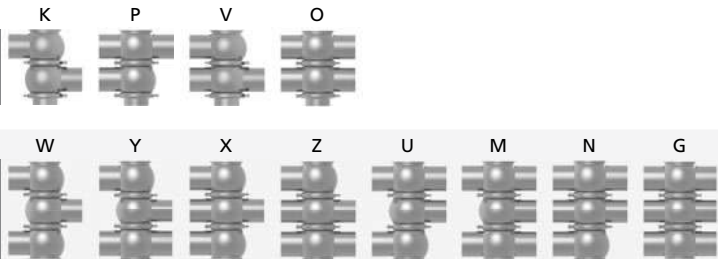
VARIVENT® housing combinations make it possible to adapt or modify existing valve systems in process systems without changing the original plant concept. During the planning stage, later system extensions can already be provided for by including housing combinations.

The ball-shaped VARIVENT® housings offer best flow profiles without flow separations, which means optimum cleaning properties. The housings, free from dead space, exactly fit in height the diameter of the connection pipes, eliminating domes and sumps and their negative consequences, e.g. damage by oxidation. VARIVENT® housing connections are available in both fixed and separable versions.

Position	Description of the order code	Available for valve type		
		W	X	Y
1	Valve type			
	W VARIVENT® divert valve X VARIVENT® divert valve			
2	Housing combinations			
		•		
3	Supplement to the valve type R Radial sealing	•		
4/5	Nominal width (upper housing / lower housing)			
	DN 25, DN 40, DN 50, DN 65, DN 80, DN 100, DN 125, DN 150 OD 1", OD 1 ½", OD 2", OD 2 ½", OD 3", OD 4", OD 6"	•	•	•
	IPS 2", IPS 3", IPS 4", IPS 6"	•	•	•
6	Blanking plates			
	0 No blanking plate	•	•	•
	1 One blanking plate	•	•	•
	2 Two blanking plates	•	•	•

Position	Description of the order code													Available for valve type				
	Valve seat version		Housing combination											W	X	Y		
K			P	V	O	W	Y	X	Z	U	M	N	G					
7	L0	Loose seat ring/ Clamp connection	√	√	√	√	√	√	√	√	√	√	√	√	•	•	•	
	V0	Fixed vertical port	√***	√***	√	√									•			
	V1	Welded seat ring/ Port orientation 90°													•***			
	V2	Welded seat ring/ Port orientation 180°													•***			
	V3	Welded seat ring/ Port orientation 270°													•***			
8	Seal material																	
	1	EPDM (FDA)														•	•	•
	2	FKM (FDA)														•	•	•
	3	HNBR (FDA)														•	•	•
9	Surface quality of the housing																	
	1**	Innen Ra ≤ 1,2 µm, outside matte blasted														•	•	•
	2*	Innen Ra ≤ 0,8 µm, outside matte blasted														•	•	•
	3	Innen Ra ≤ 0,8 µm, outside ground														•	•	•
	4	Innen Ra ≤ 0,4 µm, outside matte blasted														•	•	•
	6	Innen Ra ≤ 0,5 µm, outside matte blasted														•	•	•
	7	Innen Ra ≤ 0,5 µm, outside ground														•	•	•
10	Connection fittings																	
	N	Welding end														•	•	•
	J	With connection fitting (please specify separately in each case)														•	•	•
	TK	VARIVENT® flange connection complete, groove flange on housing														•	•	•
	TN	VARIVENT® groove flange cpl., incl. O-ring and connecting parts														•	•	•
	TF	VARIVENT® smooth flange														•	•	•
	GK	Pipe fitting S complete, male end on housing														•	•	•
	KO	Liner including groove nut SD														•	•	•
	GO	Male end SC including sealing ring G														•	•	•
	ASK	Hygienic flange connection complete, groove flange on housing														•	•	•
	NFK	Hygienic-groove flange complete, incl. O-ring and connecting parts														•	•	•
BFK	Hygienic flange														•	•	•	
CO	Clamp connection														•	•	•	

* The standard surface for DN / OD corresponds to Ra ≤ 0.8 µm.

** The standard surface for IPS corresponds to Ra ≤ 1.2 µm.

*** Only for the radial seal divert valve VARIVENT® type W_R, also with welded seat ring/port orientation 0°.

The code is composed as following, depending on the chosen configuration:

Position	1	2	3	4/5	6	7	8	9	10
Code				/					

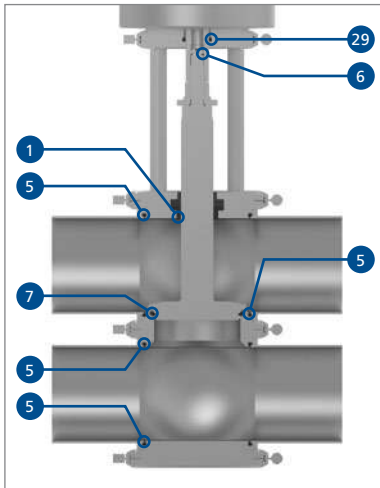

The illustration of a VARIVENT® type N single-seat valve shown here represents an example of the configuration of a seal kit for a shut-off valve. The content can differ slightly between the individual valve types.

Chiefly, a seal kit consists of all seals of the valve in question that come in contact with the product. The precise components of all seal kits and information about maintenance can be found in the associated operating instructions.

Components of a seal kit, taking the example of the VARIVENT® type N			
Position	Designation	Position	Designation
1	Sealing ring	7	V-ring
5	O-ring	29	O-ring
6	O-ring		

VARIVENT® single-seat valve type N, type U						
Nominal width			EPDM	FKM	HNBR	
DN	OD	IPS	Article number	Article number	Article number	
25	1"	–	221-304.01	221-511.80	221-519.69	
40/50	1 ½"/2"	2"	221-304.02	221-511.81	221-519.70	
65/80	2 ½"/3"	3"	221-304.03	221-511.82	221-519.71	
100	4"	4"	221-304.04	221-511.83	221-528.96	
125	–	–	221-304.05	221-511.84	–	
150	6"	6"	221-304.06	221-511.85	–	

VARIVENT® single-seat valve type N/ECO						
Nominal width		EPDM	FKM	HNBR		
DN	OD	Article number	Article number	Article number		
10/15	–	221-304.44	221-304.43	221-003871		
25	1"	221-001314	221-001318	221-001322		
50	1 ½"/2"	221-001315	221-001319	221-001323		
80	2 ½"/3"	221-001316	221-001320	221-001324		
100	4"	221-001317	221-001321	221-001325		

VARIVENT® single-seat long-stroke valve type N_V, type U_V						
Nominal width		EPDM	FKM	HNBR		
DN	OD	Article number	Article number	Article number		
65/80	2,5"/3"	221-304.03	221-511.82	221-519.71		
100	4"	221-304.04	221-511.83	221-528.96		

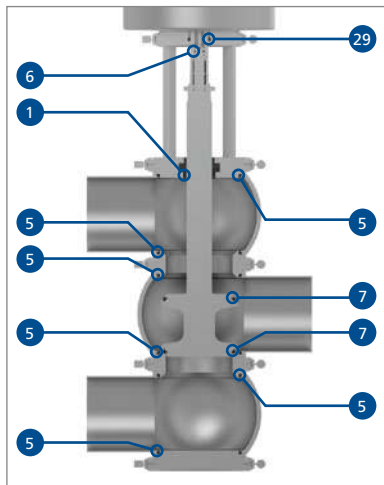

The illustration of a VARIVENT® type W single-seat valve shown here represents an example of the configuration of a seal kit for a divert valve. The content can differ slightly between the individual valve types.

Chiefly, a seal kit consists of all seals of the valve in question that come in contact with the product. The precise components of all seal kits and information about maintenance can be found in the associated operating instructions.

Components of a seal kit, taking the example of the VARIVENT® type W			
Position	Designation	Position	Designation
1	Sealing ring	7	V-ring
5	O-ring	29	O-ring
6	O-ring		

VARIVENT® single-seat valve type W*						
Nominal width			EPDM	FKM	HNBR	
DN	OD	IPS	Article number	Article number	Article number	
25	1"	-	221-304.18	221-511.87	221-519.82	
40/50	1 ½"/2"	2"	221-304.19	221-511.88	221-519.83	
65/80	2 ½"/3"	3"	221-304.20	221-511.89	221-519.84	
100	4"	4"	221-304.21	221-511.90	221-001348	
125	-	-	221-304.22	221-511.91	-	
150	6"	6"	221-304.23	221-511.92	-	

VARIVENT® single-seat valve type W/ECO						
Nominal width		EPDM	FKM	HNBR		
DN	OD	Article number	Article number	Article number		
10/15	-	221-489.32	221-489.33	221-003870		
25	1"	221-001326	221-001330	221-001334		
50	1 ½"/2"	221-001327	221-001331	221-001335		
80	2 ½"/3"	221-001328	221-001332	221-001336		
100	4"	221-001329	221-001333	221-001337		

VARIVENT® single-seat valve type W_R						
Nominal width		EPDM	FKM	HNBR		
DN	OD	Article number	Article number	Article number		
25	1"	221-519.91	221-001805	221-528.98		
40/50	1 ½"/2"	221-519.92	221-519.97	221-000756		
65/80	2 ½"/3"	221-519.93	221-519.98	221-000757		
100	4"	221-519.94	221-519.99	221-528.99		

VARIVENT® single-seat long-stroke valve type W_V						
Nominal width		EPDM	FKM	HNBR		
DN	OD	Article number	Article number	Article number		
65/80	2,5"/3"	221-304.20	221-511.89	221-519.84		
100	4"	221-304.21	221-511.90	221-001348		

VARIVENT® single-seat valve type X*						
Nominal width			EPDM	FKM	HNBR	
DN	OD	IPS	Article number	Article number	Article number	
25	1"	-	221-304.24	221-511.93	221-519.65	
40/50	1 ½"/2"	2"	221-304.25	221-511.94	221-519.66	
65/80	2 ½"/3"	3"	221-304.26	221-511.95	221-519.67	
100	4"	4"	221-304.27	221-511.96	221-004164	
125	-	-	221-304.28	221-511.97	-	
150	6"	6"	221-304.29	221-511.98	-	

VARIVENT® single-seat long-stroke valve type X_V						
Nominal width		EPDM	FKM	HNBR		
OD		Article number	Article number	Article number		
2,5"/3"		221-304.26	221-511.95	221-519.67		
OD 4"		221-304.27	221-511.96	221-004164		

* Seal kits for FFKM seal material on request



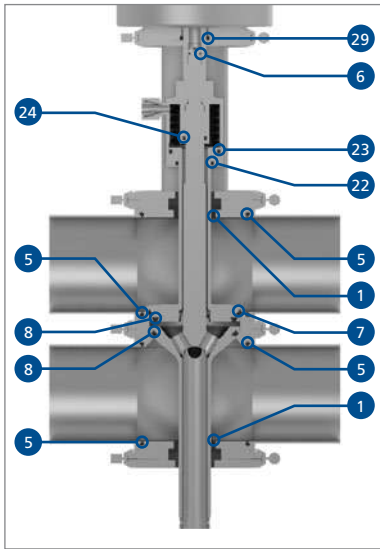

The illustration of a VARIVENT® type D double-seat valve shown here represents an example of the configuration of a seal kit for a shut-off valve. The content can differ slightly between the individual valve types.

Chiefly, a seal kit consists of all seals of the valve in question that come in contact with the product. The precise components of all seal kits and information about maintenance can be found in the associated operating instructions.

Components of a seal kit, taking the example of the VARIVENT® type D			
Position	Designation	Position	Designation
1	Sealing ring	22	O-ring
5	O-ring	23	O-ring
6	O-ring	24	O-ring
7	V-ring	29	O-ring
8	V-ring		

VARIVENT® double-seat valve type D*						
Nominal width			EPDM	FKM	HNBR	
DN	OD	IPS	Article number	Article number	Article number	
25	1"	-	221-519.58	221-519.60	221-519.72	
40/50	1 ½"/2"	2"	221-304.07	221-519.01	221-519.73	
65/80	2 ½"/3"	3"	221-304.08	221-519.02	221-519.74	
100	4"	4"	221-304.09	221-519.03	221-528.80	
125	-	-	221-304.10	221-519.04	-	
150	6"	6"	221-304.11	221-519.05	-	

VARIVENT® double-seat valve with balancer type B						
Nominal width			EPDM	FKM	HNBR	
DN	OD	IPS	Article number	Article number	Article number	
-	-	2"	221-511.37	221-519.16	221-004487	
65/80	2 ½"/3"	3"	221-511.38	221-519.17	221-004488	
100	4"	4"	221-511.39	221-519.18	221-004489	
125	-	-	221-511.40	221-519.19	-	
150	6"	6"	221-511.41	221-519.20	-	

VARIVENT® radial sealing double-seat valve type R/05						
Nominal width			EPDM	FKM	HNBR	
DN	OD	IPS	Article number	Article number	Article number	
25	1"	-	221-528.74	221-001424	221-004163	
40/50	1 ½"/2"	2"	221-511.32	221-519.11	221-000752	
65/80	2 ½"/3"	3"	221-001693	221-001695	221-004165	
100	4"	4"	221-001687	221-001688	221-004166	
125	-	-	221-001689	221-001690	-	
150	6"	6"	221-001692	221-001691	-	

VARIVENT® piggable double-seat valves type L_H, type L_S						
Nominal width		EPDM	FKM	HNBR		
DN	OD	Article number	Article number	Article number		
40/50	1 ½"/2"	221-001168	221-001169	-		
65/80	2 ½"/3"	221-001170	221-001171	-		
100	4"	221-001172	221-001173	-		

VARIVENT® double-seat valve type K*						
Nominal width			EPDM	FKM	HNBR	
DN	OD	IPS	Article number	Article number	Article number	
25	1"	-	221-304.12	221-519.32	221-519.75	
40/50	1 ½"/2"	2"	221-304.13	221-519.33	221-519.76	
65/80	2 ½"/3"	3"	221-304.14	221-519.34	221-519.77	
100	4"	4"	221-304.15	221-519.35	221-004176	
125	-	-	221-304.16	221-519.36	-	
150	6"	6"	221-304.17	221-519.37	-	

* Seal kits for FFKM seal material on request

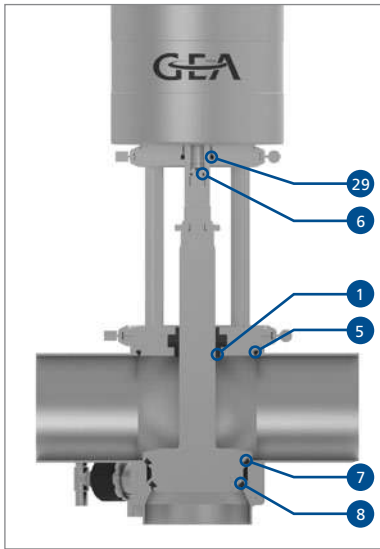

The illustration of a VARIVENT® type C double-seat valve shown here represents an example of the configuration of a seal kit for a mixproof shut-off valve. The content can differ slightly between the individual valve types.

Chiefly, a seal kit consists of all seals of the valve in question that come in contact with the product. The precise components of all seal kits and information about maintenance can be found in the associated operating instructions.

Components of a seal kit, taking the example of the VARIVENT® type C			
Position	Designation	Position	Designation
1	Sealing ring	29	O-ring
5	O-ring	175	O-ring
6	O-ring	176	O-ring
7	V-ring	177	O-ring
8	V-ring		

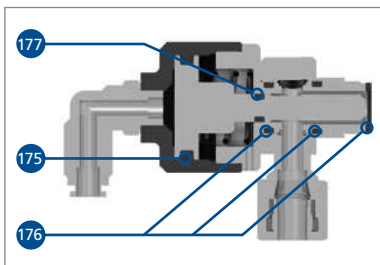

VARIVENT® double-seat valve type C*				
Nominal width		EPDM	FKM	HNBR
DN	OD	Article number	Article number	Article number
25	1"	221-528.44	221-528.45	221-528.97
40/50	1 ½"/2"	221-511.74	221-519.53	221-519.85
65/80	2 ½"/3"	221-511.75	221-519.54	221-519.86
100	4"	221-511.76	221-519.55	221-004179
125	-	221-511.77	221-519.56	-
150	-	221-511.78	221-519.57	-

* Seal kits for FFKM seal material on request

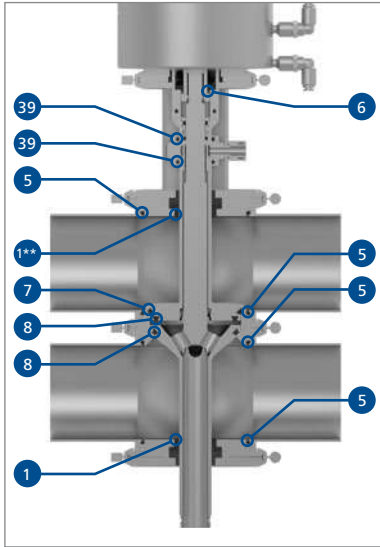

Valves with seat lifting and spray cleaning

The illustration of a VARIVENT® type D_L double-seat valve shown here represents an example of the configuration of a seal kit for a mixproof shut-off valve with seat lifting and spray cleaning. The content can differ slightly between the individual valve types.

Chiefly, a seal kit consists of all seals of the valve in question that come in contact with the product. The precise components of all seal kits and information about maintenance can be found in the associated operating instructions.

Components of a seal kit, taking the example of the VARIVENT® type D_L			
Position	Designation	Position	Designation
1	Sealing ring	7	V-ring
1**	Sealing ring	8	V-ring
5	O-ring	39	O-ring
6	O-ring		

VARIVENT® double-seat valve type D_L*						
Nominal width			EPDM	FKM	HNBR	
DN	OD	IPS	Article number	Article number	Article number	
25	1"	-	221-528.39	221-528.40	221-528.77	
40/50	1 ½"/2"	2"	221-511.27	221-519.06	221-528.78	
65/80	2 ½"/3"	3"	221-511.28	221-519.07	221-528.79	
100	4"	4"	221-511.29	221-519.08	221-528.85	
125	-	-	221-511.30	221-519.09	-	
150	6"	6"	221-511.31	221-519.10	-	

VARIVENT® double-seat valve with balancer type B_L						
Nominal width			EPDM	FKM	HNBR	
DN	OD	IPS	Article number	Article number	Article number	
-	-	2"	221-511.42	221-519.21	221-004490	
65/80	2 ½"/3"	3"	221-511.43	221-519.22	221-004492	
100	4"	4"	221-511.44	221-519.23	221-004493	
125	-	-	221-511.45	221-519.24	-	
150	6"	6"	221-511.46	221-519.25	-	

VARIVENT® radial sealing double-seat valve type R_L/05						
Nominal width			EPDM	FKM	HNBR	
DN	OD	IPS	Article number	Article number	Article number	
25	1"	-	221-528.75	221-528.76	221-004167	
40/50	1 ½"/2"	2"	221-528.19	221-528.24	221-000753	
65/80	2 ½"/3"	3"	221-001696	221-001686	221-528.91	
100	4"	4"	221-001697	221-001682	221-528.92	
125	-	-	221-001698	221-001683	-	
150	6"	6"	221-001699	221-001684	-	

VARIVENT® piggable double-seat valves type L_HL, type L_SL						
Nominal width		EPDM	FKM	HNBR		
DN	OD	Article number	Article number	Article number		
40/50	1 ½"/2"	221-001184	221-001185	-		
65/80	2 ½"/3"	221-001186	221-001187	-		
100	4"	221-001188	221-001189	-		

* Seal kits for FFKM seal material on request

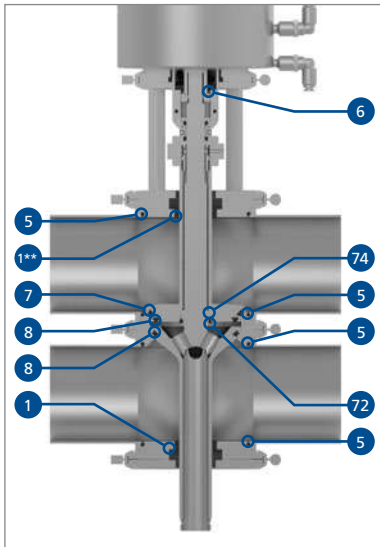

Valves with seat lifting without spray cleaning

The illustration of a VARIVENT® type D_C double-seat valve shown here represents an example of the configuration of a seal kit for a mixproof shut-off valve with seat lifting without spray cleaning. The content can differ slightly between the individual valve types.

Chiefly, a seal kit consists of all seals of the valve in question that come in contact with the product. The precise components of all seal kits and information about maintenance can be found in the associated operating instructions.

Components of a seal kit, taking the example of the VARIVENT® type D_C			
Position	Designation	Position	Designation
1	Sealing ring	7	V-ring
1**	Sealing ring	8	V-ring
5	O-ring	72	O-ring
6	O-ring	74	Snap seal

VARIVENT® double-seat valve type D_C*						
Nominal width			EPDM	FKM	HNBR	
DN	OD	IPS	Article number	Article number	Article number	
25	1"	-	221-528.43	221-001036	221-528.81	
40/50	1 ½"/2"	2"	221-001025	221-001037	221-528.82	
65/80	2 ½"/3"	3"	221-001026	221-001038	221-528.83	
100	4"	4"	221-001027	221-001039	221-528.84	
125	-	-	221-001028	221-001040	-	
150	6"	6"	221-001029	221-001041	-	

VARIVENT® double-seat valve with balancer type B_C						
Nominal width			EPDM	FKM	HNBR	
DN	OD	IPS	Article number	Article number	Article number	
-	-	2"	221-519.87	221-001049	221-528.93	
65/80	2 ½"/3"	3"	221-519.88	221-001050	221-528.94	
100	4"	4"	221-519.89	221-001051	221-528.95	
125	-	-	221-001030	221-001052	-	
150	6"	6"	221-519.90	221-001053	-	

VARIVENT® radial sealing double-seat valve type R_C/05						
Nominal width			EPDM	FKM	HNBR	
DN	OD	IPS	Article number	Article number	Article number	
25	1"	-	221-000024	221-001042	221-004180	
40/50	1 ½"/2"	2"	221-001031	221-001043	221-001394	
65/80	2 ½"/3"	3"	221-001700	221-001681	221-528.88	
100	4"	4"	221-001701	221-001677	221-001678	
125	-	-	221-001702	221-001679	-	
150	6"	6"	221-001703	221-001680	-	

VARIVENT® piggable double-seat valves type L_HC, type L_SC						
Nominal width		EPDM	FKM	HNBR		
DN	OD	Article number	Article number	Article number		
40/50	1 ½"/2"	221-001176	221-001177	-		
65/80	2 ½"/3"	221-001178	221-001179	-		
100	4"	221-001180	221-001181	-		

24/7 PMO Valve® 2.0 type M/2.0						
Nominal width		EPDM	FKM	HNBR		
OD		Article number	Article number	Article number		
1 ½"/2"		221-004538	221-004539	221-004540		
2 ½"/3"		221-004547	221-004548	221-004549		
4"		221-004550	221-004551	221-004552		
6"		221-004553	221-004554	-		

* Seal kits for FFKM seal material on request



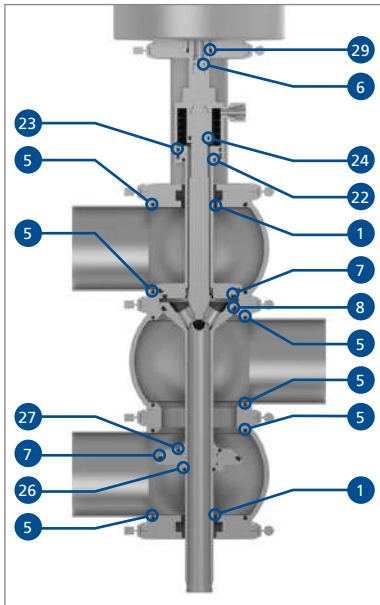

The illustration of a VARIVENT® type Y double-seat valve shown here represents an example of the configuration of a seal kit for a mixproof divert valve. The content can differ slightly between the individual valve types.

Chiefly, a seal kit consists of all seals of the valve in question that come in contact with the product. The precise components of all seal kits and information about maintenance can be found in the associated operating instructions.

Components of a seal kit, taking the example of the VARIVENT® type Y			
Position	Designation	Position	Designation
1	Sealing ring	23	O-ring
5	O-ring	24	O-ring
6	O-ring	26	O-ring
7	V-ring	27	O-ring
8	V-ring	29	O-ring
22	O-ring		

VARIVENT® double-seat valve type Y									
Nominal width			EPDM		FKM		HNBR		
DN	OD	IPS	Article number		Article number		Article number		
25	1"	-	221-519.59		221-519.61		221-519.78		
40/50	1 ½"/2"	2"	221-304.30		221-519.39		221-519.79		
65/80	2 ½"/3"	3"	221-304.31		221-519.40		221-519.80		
100	4"	4"	221-304.32		221-519.41		-		
125	-	-	221-304.33		221-519.42		-		
150	6"	6"	221-304.34		221-519.43		-		

VARIVENT® double-seat valve type Y_L									
Nominal width			EPDM		FKM		HNBR		
DN	OD	IPS	Article number		Article number		Article number		
25	1"	-	221-002085		221-002086		221-004497		
40/50	1 ½"/2"	2"	221-511.65		221-519.44		221-002761		
65/80	2 ½"/3"	3"	221-511.66		221-519.45		221-000758		
100	4"	4"	221-511.67		221-519.46		221-004498		
125	-	-	221-511.68		221-519.47		-		
150	6"	6"	221-511.69		221-519.48		-		

VARIVENT® double-seat valve type Y_C									
Nominal width			EPDM		FKM		HNBR		
DN	OD	IPS	Article number		Article number		Article number		
25	1"	-	221-002369		221-004006		221-004499		
40/50	1 ½"/2"	2"	221-001430		221-001431		221-004500		
65/80	2 ½"/3"	3"	221-001432		221-001433		221-004501		
100	4"	4"	221-001434		221-001435		221-004503		
125	-	-	221-001436		221-001437		-		
150	6"	6"	221-001438		221-001439		-		

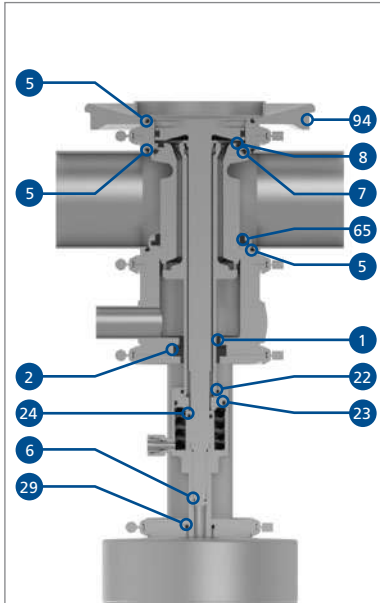

The illustration of a VARIVENT® type T_R tank bottom valve shown here represents an example of the configuration of a seal kit for a tank bottom valve. The content can differ slightly between the individual valve types.

Chiefly, a seal kit consists of all seals of the valve in question that come in contact with the product. The precise components of all seal kits and information about maintenance can be found in the associated operating instructions.





Note: The seal kits for single-seat valves type N, N/ECO and type U are used for tank bottom valves type N and U.















Components of a seal kit, taking the example of the VARIVENT® type T_R			
Position	Designation	Position	Designation
1	Sealing ring	22	O-ring
2	Warehouse	23	O-ring
5	O-ring	24	O-ring
6	O-ring	29	O-ring
7	V-ring	65	Sealing ring
8	V-ring	94	V-ring RA









VARIVENT® radial sealing double-seat bottom valve type T_R						
Nominal width			EPDM	FKM	HNBR	
DN	OD	IPS	Article number	Article number	Article number	
40/50	1 ½"/2"	2"	221-000834	221-000835	221-004494	
65/80	2 ½"/3"	3"	221-000836	221-000837	221-004505	
100	4"	4"	221-000838	221-000839	221-004242	
125	-	-	221-001121	221-001122	-	
150	6"	6"	221-002827	221-002828	-	

VARIVENT® radial sealing double-seat bottom valve type T_RL						
Nominal width			EPDM	FKM	HNBR	
DN	OD	IPS	Article number	Article number	Article number	
40/50	1,5"/2"	2"	221-000828	221-000829	221-004208	
65/80	2,5"/3"	3"	221-000830	221-000831	221-004211	
100	4"	4"	221-000832	221-000833	221-004212	
125	-	-	221-001125	221-001126	-	
150	6"	6"	221-002831	221-002833	-	

VARIVENT® radial sealing double-seat bottom valve type T_RC						
Nominal width			EPDM	FKM	HNBR	
DN	OD	IPS	Article number	Article number	Article number	
25	1"	-	221-002613	221-002614	221-004342	
40/50	1 ½"/2"	2"	221-000822	221-000823	221-004495	
65/80	2 ½"/3"	3"	221-000824	221-000825	221-004306	
100	4"	4"	221-000826	221-000827	221-004255	
125	-	-	221-001123	221-001124	-	
150	6"	6"	221-002829	221-002830	-	

Lubricant		
	Tool	Article number
	Rivolta F.L.G. MD-2	413-071
Basic tools		
	Tool	Article number
	Hose cutter	407-065
	Strap wrench	408-142
	Vice support	470-001
	Scriber 250 mm (for removing seals)	414-001

VARIVENT® single-seat valves type N, N_V, U, U_V, W, W_R, W_V			
Nominal width		Tool	Article number
DN 25 DN 40 DN 50 OD 1" OD 1 ½" OD 2"		Allen key 3 mm	408-121
		Open-end spanner 10x11 mm	408-033
		Open-end spanner 12x13 mm	408-034
		Open-end spanner 17x19 mm (ground down)	229-119.01
		Open-end spanner 21x23 mm (ground down)	229-119.05
		V-ring insertion tool	229-109.88
DN 65 DN 80 DN 100 OD 2 ½" OD 3" OD 4"		Allen key 3 mm	408-121
		Open-end spanner 12x13 mm	408-034
		Open-end spanner 21x23 mm (ground down)	229-119.05
		V-ring insertion tool	229-109.88
DN 125 DN 150 OD 6"		Allen key 3 mm	408-121
		Open-end spanner 12x13 mm	408-034
		Open-end spanner 17x19 mm (ground down)	229-119.01
		Open-end spanner 30x32 mm	408-041
		V-ring insertion tool	229-109.88

ECOVENT® single-seat valves type N/ECO, W/ECO			
Nominal width		Tool	Article number
		Allen key 3 mm	408-121
DN 10		Open-end spanner 10x11 mm	408-033
DN 15		Open-end spanner 12x13 mm	408-034
DN 25		Open-end spanner 17x19 mm (ground down)	229-119.01
DN 40		Open-end spanner 24x27 mm (ground down)	229-119.04
DN 50			
DN 65			
DN 80			
DN 100			
OD 1"		Split pin actuator with handle 6 mm	403-211
OD 1 1/2"			
OD 2"		Adjustable face wrench 11/60 3 mm	408-269
OD 2 1/2"			
OD 3"		Mounting fixture ECO-lantern DN 100	229-000071
OD 4"		V-ring insertion tool	229-109.88

VARIVENT® single-seat long-stroke valves type N_V, U_V

The tools of the VARIVENT® single-seat valves type N, U are used for VARIVENT® single-seat long-stroke valves type N_V, U_V















VARIVENT® single-seat valves type W, W_R, W_V









The tools of the VARIVENT® single-seat valves type N, U are used for VARIVENT® single-seat valves type W, W_R, W_V

ECOVENT® single-seat valves type W/ECO

The tools of the ECOVENT® single-seat valve type N/ECO are used for ECOVENT® single-seat valve type W/ECO (see above)

















VARIVENT® single-seat valves type X, X_V			
Nominal width		Tool	Article number
DN 25 DN 40 DN 50 OD 1" OD 1 ½" OD 2"		Allen key 3 mm	408-121
		Open-end spanner 10x11 mm	408-033
		Open-end spanner 12x13 mm	408-034
		Open-end spanner 14x17 mm	408-045
		Open-end spanner 17x19 mm (ground down)	229-119.01
		Open-end spanner 21x23 mm (ground down)	229-119.05
		V-ring insertion tool	229-109.88
DN 65 DN 80 DN 100 OD 2 ½" OD 3" OD 4"		Allen key 3 mm	408-121
		Open-end spanner 12x13 mm	408-034
		Open-end spanner 17x19 mm (ground down)	229-119.01
		Open-end spanner 21x23 mm (ground down)	229-119.05
		V-ring insertion tool	229-109.88
DN 125 DN 150 OD 6"		Allen key 3 mm	408-121
		Open-end spanner 12x13 mm	408-034
		Open-end spanner 17x19 mm (ground down)	229-119.01
		Open-end spanner 22x24 mm	229-119.03
		Open-end spanner 30x32 mm	408-041
		V-ring insertion tool	229-109.88

VARIVENT® double-seat valves type D, B, R			
Nominal width		Tool	Article number
DN 25 DN 40 DN 50 OD 1" OD 1 ½" OD 2"		Allen key 3 mm	408-121
		Open-end spanner 10x11 mm	408-033
		Open-end spanner 12x13 mm	408-034
		Open-end spanner 17x19 mm (ground down)	229-119.01
		Mounting tool VT	229-109.92
		Installation mandrel DS	229-109.04
		V-ring insertion tool	229-109.88
DN 65 DN 80 DN 100 OD 2 ½" OD 3" OD 4"		Allen key 3 mm	408-121
		Open-end spanner 12x13 mm	408-034
		Open-end spanner 17x19 mm (ground down)	229-119.01
		Open-end spanner 21x23 mm (ground down)	229-119.05
		Mounting tool VT	229-109.93
		Installation mandrel DS	229-109.05
		Split pin actuator with handle 6 mm	403-211
		V-ring insertion tool	229-109.88

VARIVENT® double-seat valves type D, B, R			
Nominal width		Tool	Article number
DN 125 DN 150 OD 6"		Allen key 3 mm	408-121
		Open-end spanner 12x13 mm	408-034
		Open-end spanner 17x19 mm (ground down)	229-119.01
		Open-end spanner 24x27 mm (ground down)	229-119.04
		Open-end spanner 30x32 mm	408-041
		Mounting tool VT	229-109.94
		Installation mandrel DS	229-109.06
		Split pin actuator with handle 6 mm	403-211
		V-ring insertion tool	229-109.88

VARIVENT® piggable double-seat valves type L_H, L_S







The tools of the VARIVENT® radial sealing double-seat bottom valve type T_R are used for VARIVENT® piggable double-seat valves type L_H, L_S

















VARIVENT® double-seal valve type C			
Nominal width		Tool	Article number
DN 25 DN 40 DN 50 OD 1" OD 1 ½" OD 2"		Allen key 3 mm	408-121
		Open-end spanner 10x11 mm	408-033
		Open-end spanner 12x13 mm	408-034
		Open-end spanner 17x19 mm (ground down)	229-119.01
		Open-end spanner 21x23 mm (ground down)	229-119.05
		Open-end spanner 30x32 mm	408-041
		V-ring insertion tool	229-109.88
DN 65 DN 80 DN 100 OD 2 ½" OD 3" OD 4"		Allen key 3 mm	408-121
		Open-end spanner 12x13 mm	408-034
		Open-end spanner 21x23 mm (ground down)	229-119.05
		Open-end spanner 30x32 mm	408-041
		V-ring insertion tool	229-109.88
DN 125 DN 150 OD 6"		Allen key 3 mm	408-121
		Open-end spanner 12x13 mm	408-034
		Open-end spanner 21x23 mm (ground down)	229-119.05
		Open-end spanner 30x32 mm	408-041
		V-ring insertion tool	229-109.88



















VARIVENT® double-seat valve type K			
Nominal width		Tool	Article number
DN 25 DN 40 DN 50 OD 1" OD 1 ½" OD 2"		Allen key 3 mm	408-121
		Open-end spanner 10x11 mm	408-033
		Open-end spanner 12x13 mm	408-034
		Open-end spanner 17x19 mm (ground down)	229-119.01
		Open-end spanner 22x24 mm	229-119.03
		Installation mandrel	229-109.95
		V-ring insertion tool	229-109.88
DN 65 DN 80 DN 100 OD 2 ½" OD 3" OD 4"		Allen key 3 mm	408-121
		Open-end spanner 12x13 mm	408-034
		Open-end spanner 17x19 mm (ground down)	229-119.01
		Open-end spanner 22x24 mm	229-119.03
		Installation mandrel	229-109.96
		V-ring insertion tool	229-109.88
DN 125 DN 150 OD 6"		Allen key 3 mm	408-121
		Open-end spanner 12x13 mm	408-034
		Open-end spanner 17x19 mm (ground down)	229-119.01
		Open-end spanner 22x24 mm	229-119.03
		Open-end spanner 27x30 mm	229-119.04
		V-ring insertion tool	229-109.88

VARIVENT® double-seat valves type D_L, D_C, B_L*, B_C*			
Nominal width		Tool	Article number
DN 25 OD 1"		Allen key 3 mm	408-121
		Open-end spanner 10x11 mm	408-033
		Open-end spanner 12x13 mm	408-034
		Open-end spanner 17x19 mm (ground down)	229-119.01
		Mounting tool VT	229-109.92
		Installation mandrel DS	229-109.04
		Hook wrench 25/28	408-203
		V-ring insertion tool	229-109.88
DN 40 DN 50 OD 1 1/2" OD 2"		Allen key 3 mm	408-121
		Open-end spanner 10x11 mm	408-033
		Open-end spanner 12x13 mm	408-034
		Open-end spanner 17x19 mm (ground down)	229-119.01
		Mounting tool VT	229-109.92
		Installation mandrel DS	229-109-04
		Hook wrench 30/32	408-202
		Split pin actuator with handle 6 mm	403-211
		V-ring insertion tool	229-109.88











* Does not apply to the nominal widths DN 25, DN 40, OD 1", OD 1 1/2"

VARIVENT® double-seat valves type D_L, D_C, B_L, B_C			
Nominal width		Tool	Article number
DN 65 DN 80 DN 100 OD 2 1/2" OD 3" OD 4"		Allen key 3 mm	408-121
		Open-end spanner 12x13 mm	408-034
		Open-end spanner 17x19 mm (ground down)	229-119.01
		Open-end spanner 21x23 mm (ground down)	229-119.05
		Mounting tool VT	229-109.93
		Installation mandrel DS	229-109.05
		Hook wrench 34/36	408-191
		Split pin actuator with handle 6 mm	403-211
		V-ring insertion tool	229-109.88
DN 125 DN 150 OD 6"		Allen key 3 mm	408-121
		Open-end spanner 12x13 mm	408-034
		Open-end spanner 17x19 mm (ground down)	229-119.01
		Open-end spanner 30x32 mm	408-041
		Mounting tool VT	229-109.94
		Installation mandrel DS	229-109.06
		Hook wrench 45/50	408-205
		Split pin actuator with handle 6 mm	403-211
		V-ring insertion tool	229-109.88











VARIVENT® double-seat valves type R_L, R_C			
Nominal width		Tool	Article number
DN 25 OD 1"		Allen key 3 mm	408-121
		Open-end spanner 10x11 mm	408-033
		Open-end spanner 12x13 mm	408-034
		Open-end spanner 17x19 mm (ground down)	229-119.01
		Installation mandrel DS	229-109.04
		Hook wrench 25/28	408-203
		Snap ring pliers	9077244
		Box spanner 32/36	408-208
		V-ring insertion tool	229-109.88
DN 40 DN 50 OD 1 1/2" OD 2"		Allen key 3 mm	408-121
		Open-end spanner 10x11 mm	408-033
		Open-end spanner 12x13 mm	408-034
		Open-end spanner 17x19 mm (ground down)	229-119.01
		Installation mandrel DS	229-109.04
		Hook wrench 30/32	408-202
		Snap ring pliers	9077244
		Box spanner 32/36	408-208
		V-ring insertion tool	229-109.88

VARIVENT® double-seat valves type R_L, R_C			
Nominal width		Tool	Article number
DN 65 DN 80 DN 100 OD 2 1/2" OD 3" OD 4"		Allen key 3 mm	408-121
		Open-end spanner 12x13 mm	408-034
		Open-end spanner 17x19 mm (ground down)	229-119.01
		Open-end spanner 21x23 mm (ground down)	229-119.05
		Installation mandrel DS	229-109.05
		Hook wrench 34/36	408-191
		Snap ring pliers	9077244
		Box spanner 32/36	408-208
		V-ring insertion tool	229-109.88
DN 125 DN 150 OD 6"		Allen key 3 mm	408-121
		Open-end spanner 12x13 mm	408-034
		Open-end spanner 17x19 mm (ground down)	229-119.01
		Open-end spanner 30x32 mm	408-041
		Installation mandrel DS	229-109.06
		Hook wrench 45/50	408-193
		Snap ring pliers	9077244
		Box spanner 32/36	408-208
		V-ring insertion tool	229-109.88
VARIVENT® piggable double-seat valves type L_HL, L_HC, L_SL, L_SC			
The tools of the VARIVENT® radial sealing double-seat bottom valve type T_RL, T_RC are used for VARIVENT® piggable double-seat valves type L_HL, L_HC, L_SL, L_SC			

24/7 PMO Valve® 2.0			
Nominal width		Tool	Article number
OD 1 1/2" OD 2"		Allen key 3 mm	408-121
		Open-end spanner 10x11 mm	408-033
		Open-end spanner 13x15 mm	408-035
		Open-end spanner 14x17 mm	408-045
		Box spanner 32/36	408-208
		Mounting tool VT	229-109.92
		Installation mandrel DS	229-109.05
		Hook wrench 30/32	408-202
		Split pin actuator with handle 6 mm	403-211
		V-ring insertion tool	229-109.88
OD 2 1/2" OD 3" OD 4"		Allen key 3 mm	408-121
		Open-end spanner 10x11 mm	408-033
		Open-end spanner 13x15 mm	408-035
		Open-end spanner 14x17 mm	408-045
		Open-end spanner 16x18 mm	408-183
		Box spanner 32/36	408-208
		Mounting tool VT	229-109.93
		Installation mandrel DS	229-109.05
		Hook wrench 34/36	408-191
		Split pin actuator with handle 6 mm	403-211
		V-ring insertion tool	229-109.88

24/7 PMO Valve® 2.0			
Nominal width		Tool	Article number
OD 6"		Allen key 3 mm	408-121
		Open-end spanner 13x15 mm	408-035
		Open-end spanner 14x17 mm	408-045
		Open-end spanner 16x18 mm	408-183
		Box spanner 32/36	408-208
		Mounting tool VT	229-109.94
		Installation mandrel DS	229-109.06
		Hook wrench 45/50	408-205
		Split pin actuator with handle 6 mm	403-211
		V-ring insertion tool	229-109.88

















VARIVENT® double-seat valve type Y			
Nominal width		Tool	Article number
DN 25 DN 40 DN 50 OD 1" OD 1 ½" OD 2"		Allen key 3 mm	408-121
		Open-end spanner 10x11 mm	408-033
		Open-end spanner 12x13 mm	408-034
		Open-end spanner 17x19 mm (ground down)	229-119.01
		Mounting tool VT	229-109.92
		Mounting tool Y	229-109.10
		Installation mandrel DS	229-109.04
		V-ring insertion tool	229-109.88
DN 65 DN 80 DN 100 OD 2 ½" OD 3" OD 4"		Allen key 3 mm	408-121
		Open-end spanner 12x13 mm	408-034
		Open-end spanner 17x19 mm (ground down)	229-119.01
		Open-end spanner 21x23 mm (ground down)	229-119.05
		Mounting tool VT	229-109.93
		Mounting tool Y	229-109.12
		Installation mandrel DS	229-109.05
		Split pin actuator with handle 6 mm	403-211
		V-ring insertion tool	229-109.88











VARIVENT® double-seat valve type Y			
Nominal width		Tool	Article number
DN 125 DN 150 OD 6"		Allen key 3 mm	408-121
		Open-end spanner 12x13 mm	408-034
		Open-end spanner 17x19 mm (ground down)	229-119.01
		Open-end spanner 24x27 mm (ground down)	229-119.04
		Open-end spanner 30x32 mm	408-041
		Mounting tool VT	229-109.94
		Mounting tool Y	229-109.15
		Installation mandrel DS	229-109.06
		Split pin actuator with handle 6 mm	403-211
		V-ring insertion tool	229-109.88

VARIVENT® double-seat valves type Y_L, Y_C			
Nominal width		Tool	Article number
DN 25 OD 1"		Allen key 3 mm	408-121
		Open-end spanner 10x11 mm	408-033
		Open-end spanner 12x13 mm	408-034
		Open-end spanner 17x19 mm (ground down)	229-119.01
		Mounting tool VT	229-109.92
		Installation mandrel DS	229-109.04
		Hook wrench 25/28	408-203
		V-ring insertion tool	229-109.88
DN 40 DN 50 OD 1 1/2" OD 2"		Allen key 3 mm	408-121
		Open-end spanner 10x11 mm	408-033
		Open-end spanner 12x13 mm	408-034
		Open-end spanner 17x19 mm (ground down)	229-119.01
		Mounting tool VT	229-109.92
		Mounting tool Y	229-109.10
		Installation mandrel DS	229-109.04
		Hook wrench 30/32	408-202
		Split pin actuator with handle 6 mm	403-211
		V-ring insertion tool	229-109.88

VARIVENT® double-seat valves type Y_L, Y_C			
Nominal width		Tool	Article number
DN 65 DN 80 DN 100 OD 2 1/2" OD 3" OD 4"		Allen key 3 mm	408-121
		Open-end spanner 12x13 mm	408-034
		Open-end spanner 17x19 mm (ground down)	229-119.01
		Open-end spanner 21x23 mm (ground down)	229-119.05
		Mounting tool VT	229-109.93
		Mounting tool Y	229-109.12
		Installation mandrel DS	229-109.05
		Hook wrench 34/36	408-191
		Split pin actuator with handle 6 mm	403-211
		V-ring insertion tool	229-109.88
DN 125 DN 150 OD 6"		Allen key 3 mm	408-121
		Open-end spanner 12x13 mm	408-034
		Open-end spanner 17x19 mm (ground down)	229-119.01
		Open-end spanner 30x32 mm	408-041
		Mounting tool VT	229-109.94
		Mounting tool Y	229-109.15
		Installation mandrel DS	229-109.06
		Hook wrench 45/50	408-205
		Split pin actuator with handle 6 mm	403-211
		V-ring insertion tool	229-109.88

VARIVENT® radial sealing double-seat bottom valves type T_R, L_H, L_S			
Nominal width		Tool	Article number
DN 40 DN 50 OD 1 ½" OD 2"		Allen key 3 mm	408-121
		Open-end spanner 10x11 mm	408-033
		Open-end spanner 12x13 mm	408-034
		Open-end spanner 17x19 mm (ground down)	229-119.01
		Wrench socket, turned down 27 mm	229-119.06
		V-ring insertion tool	229-109.88
DN 65 DN 80 DN 100 OD 2 ½" OD 3" OD 4"		Allen key 3 mm	408-121
		Open-end spanner 12x13 mm	408-034
		Open-end spanner 17x19 mm (ground down)	229-119.01
		Open-end spanner 21x23 mm	229-119.05
		Wrench socket, turned down 27 mm	229-119.06
		V-ring insertion tool	229-109.88
DN 125		Allen key 3 mm	408-121
		Open-end spanner 12x13 mm	408-034
		Open-end spanner 17x19 mm (ground down)	229-119.01
		Open-end spanner 30x32 mm	408-041
		Wrench socket, turned down 27 mm	229-119.06
		V-ring insertion tool	229-109.88

VARIVENT® radial sealing double-seat bottom valves type T_RL, T_RC, L_HL, L_SL			
Nominal width		Tool	Article number
DN 40 DN 50 OD 1 ½" OD 2"		Allen key 3 mm	408-121
		Open-end spanner 10x11 mm	408-033
		Open-end spanner 12x13 mm	408-034
		Open-end spanner 17x19 mm (ground down)	229-119.01
		Snap ring pliers	9065838
		Hook wrench 32/36	408-202
		Box spanner 30/32	408-208
		Wrench socket, turned down 27 mm	229-119.06
	V-ring insertion tool	229-109.88	
DN 65 DN 80 DN 100 OD 2 ½" OD 3" OD 4"		Allen key 3 mm	408-121
		Open-end spanner 12x13 mm	408-034
		Open-end spanner 17x19 mm (ground down)	229-119.01
		Open-end spanner 21x23 mm	229-119.05
		Snap ring pliers	9065838
		Hook wrench 34/36	408-191
		Box spanner 32/36	408-208
		Wrench socket, turned down 27 mm	229-119.06
		V-ring insertion tool	229-109.88

VARIVENT® radial sealing double-seat bottom valves type T_RL, T_RC, L_HL, L_SL			
Nominal width		Tool	Article number
DN 125		Allen key 3 mm	408-121
		Open-end spanner 12x13 mm	408-034
		Open-end spanner 17x19 mm (ground down)	229-119.01
		Open-end spanner 30x32 mm	408-041
		Mounting tool VT	229-109.94
		Snap ring pliers	9065838
		Hook wrench 45/50	408-205
		Box spanner 32/36	408-208
		Wrench socket, turned down 27 mm	229-119.06
		V-ring insertion tool	229-109.88

T.VIS® control top

The T.VIS® control top is an optimal system for controlling and monitoring GEA Tuchenhagen valves.

This is available in several variants depending on the valve type, tasks and user convenience.

Common features of all T.VIS® variants are:

- Flexible modular system for optimum variant configuration for the particular task (e.g. type of interface module, number of solenoid valves, etc.)
- Internal air supply for high security against failure of the main valve functions because no external air hose is required
- Characteristic design
- High Protection class (min. IP66, optional IP67 or IP69k)
- Ease of cleaning without dead zones, whatever the installation orientation
- Clear visualization of the valve status via a light dome visible 360°, which is illuminated by colored LEDs
- Low energy consumption
- Ease of handling
- Maintenance-free electronic modules
- Many special options, e.g.:
 - Air throttles
 - Cable connections, etc.

For maintenance work on the valve, the control tops can be removed from the valve actuator by loosening two bolts on the clamp, without electrical or pneumatic connections having to be disconnected.

T.VIS® concept – for valves with pneumatic actuator



T.VIS® M-15 – control top with manual sensor setting

- For open/close position feedback and actuator control
- Proven sensor technology
- Modules and solenoid valves can be retrofitted



T.VIS® A-15 – control top with automatic set-up

- For open/close position feedback and actuator control
- Automatic set-up
- Semi-automatic setup



T.VIS® P-15 – positioning of the valve disc

- For infinitely definable positioning of the valve disc between the open/close positions
- Automatic set-up



SES – control top for potentially explosive areas

- For open/close position feedback and actuator control
- Intrinsically safe sensors and solenoid valves



INA – proximity switch holder on the actuator

- For 2 proximity switches M12x1



LAT – proximity switch holder in the lantern

- For 2 proximity switches M12x1

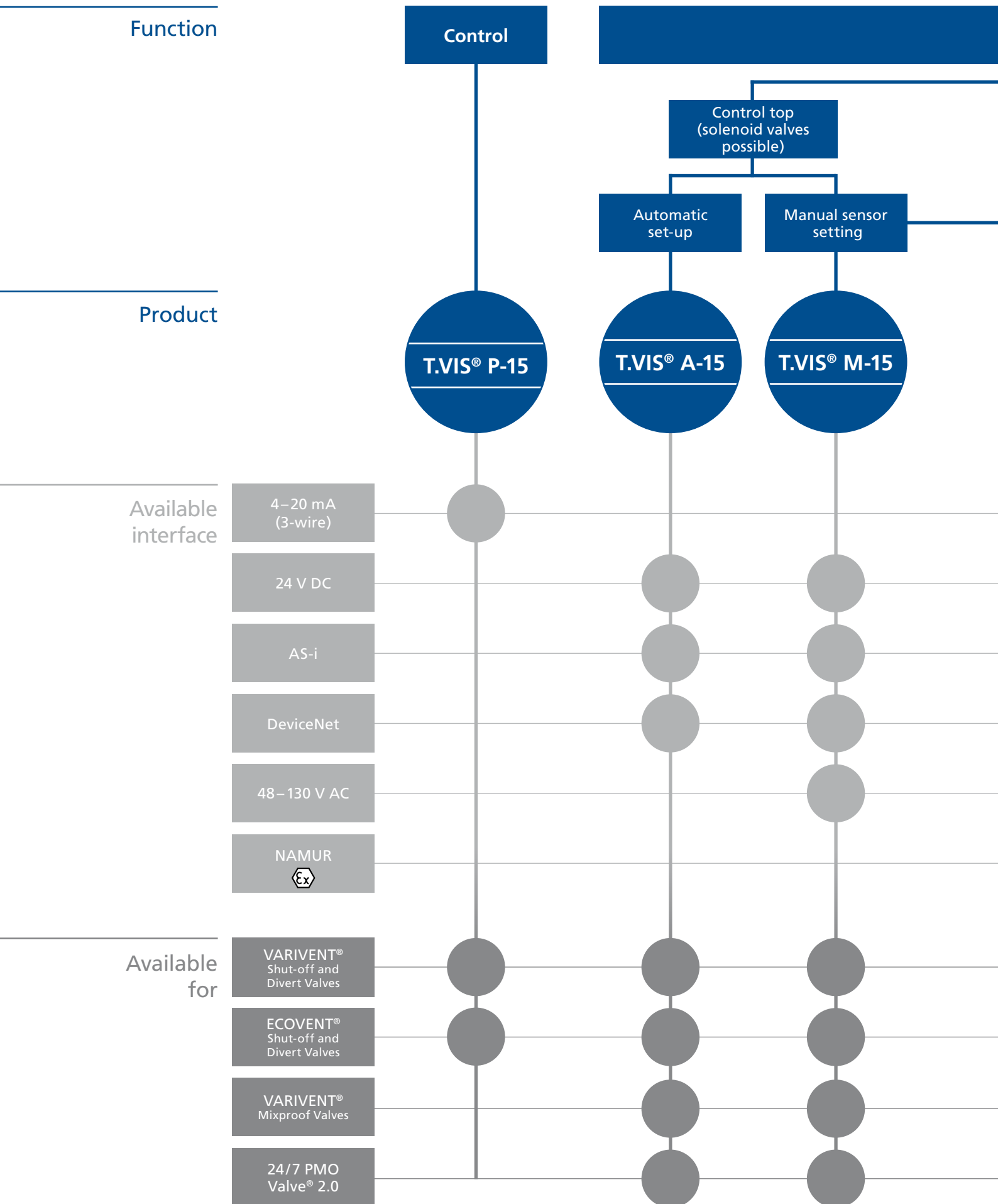

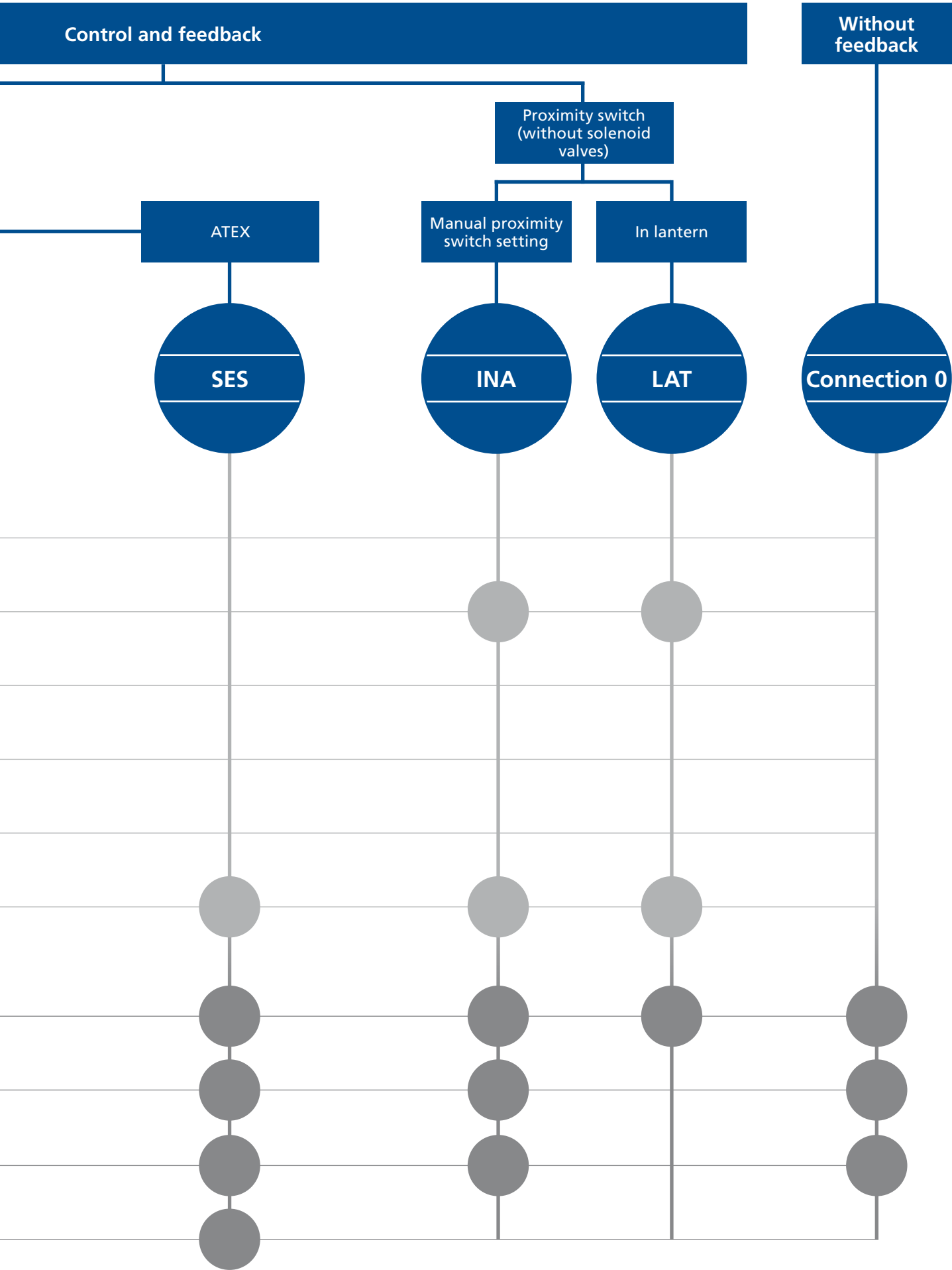

Concept

The T.VIS® M-15 is equipped with manually adjustable sensors and a modular system of options, all of which form the basics of the T.VIS® feedback technology. This means it is optimally adapted to the basic requirements of the process system.

With proven sensor technology, it offers the advantages of the modern T.VIS® series in an inexpensive manner.

Standard variant



- 1 Pneumatic block
- 2 24 V DC interface module
- 3 Sensors
- 4 Solenoid valves
- 5 LED lighting
- 6 Central compressed air connection with replaceable filter
- 7 Cable gland

Features

- Flexible modular system
- Use of proven sensor technology
- Quick and easy adjustment of the sensors
- Valve status indication by LED
- Various communication standards available
- Components can be upgraded/converted subsequently
- Filter protects solenoid valves
- High-quality pneumatic fittings
- Exchangeable compressed air connection
- Supply and exhaust air throttles can be fitted
- Logic NOT-element
- Standard protection class IP66

Structure

The T.VIS® M-15 is characterized by proven sensor technology. The basic equipment of the control top comprises of the 24 V DC interface module with two sensors for feedback of the valve position and three solenoid valves which can be installed subsequently, if necessary.

In the interface types with AC (alternating current), DeviceNet and AS-Interface, an adapter module is connected ahead of the standard interface module, and can also be retrofitted or converted.

A replaceable filter in the supply air connection protects the solenoid valves.

Position detection

Inductive sensor system – The valve positions are detected using two manually adjustable sensors.

Setting

Mechanical – the sensors are calibrated mechanically using the positioning spindles, which are subsequently secured to prevent self-adjustment.

Logic NOT-element

A logic NOT-element is available as an option. It simplifies wiring with automatic air support of the spring in the actuator, in order to increase the holding force of the valve.

For more information about the logic NOT-element, refer to the end of this section.

Visualization

LED display:

- green
- yellow





Technical data of the standard version		
Position detection	Sensors	
Housing material	PA 12/L	
Ambient temperature	-20 to +60 °C	
Air supply	Pressure range	2 to 8 bar
	Standard	acc. to ISO 8573-1:2010
	Solid content	Quality class 6
	Water content	Quality class 4
	Oil content	Quality class 3
Dimensions of air connections	Metric 6/4 mm, inch 6.35/4.31 mm (¼")	
Protection class	IP66 (powerful water jet)	
Sound pressure level via exhaust air throttle	Max. 72 dB	
Visualization	LED (green, yellow)	
Certificates (optional)		• CSA C22.2
		• UL 429

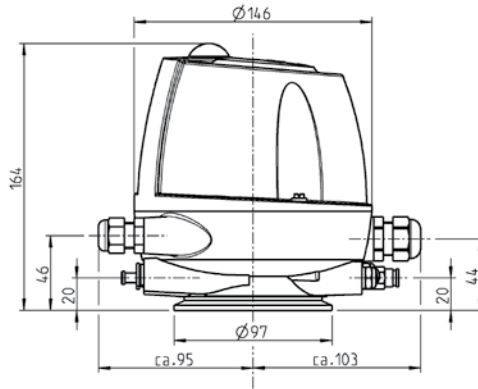

Type of interface	24 V DC, 3-wire, PNP 24 V DC, 3-wire, NPN	48 – 130 V AC
Supply		
Operating voltage	24 V DC (+20 %, -12.5 %)	48 – 130 V AC
No-load current	≤ 40 mA	≤ 51 mA
Maximum current consumption	285 mA	185 mA
Polarity reversal protection	Yes	Yes
Certificate	cCSAus	cULus
Inputs		
Activation voltage	21 – 28.8 V = high; < 16 V = low	48 – 130 V = high*; < 30 V = low > 1.5 mA = high*; < 0.4 mA = low
Current consumption per input	≤ 35 mA	≤ 3 mA
Activation "PV Y1"	Direct PV activation	Electronic input
Activation "PV Y2"	Direct PV activation	Electronic input
Activation "PV Y3"	Direct PV activation	Electronic input
Outputs		
Connection type	24 V DC (PNP/NPN with changeover function)	
Maximum current carrying capacity per feedback output	50 mA	≤ 100 mA
Voltage drop on the outputs	≤ 3 V	≤ 5 V
Feedback "start position"	Electronic outputs	Electronic outputs
Feedback "end position"	Electronic outputs	Electronic outputs
Feedback "seat lift position"	Electronic outputs	Electronic outputs

* Leakage currents can arise if PLC modules with electronic outputs are used. If the leakage currents are more than 1.5 mA, it is essential to use a load resistor in parallel with the interface module. Recommendation: 15 kΩ/2 W

Position	Description of the order code
14	Feedback location TM15 Control top T.VIS® M-15
15	Control top type N Without solenoid valve P 1 solenoid valve Y1 R 1 solenoid valve Y1 (retrofittable: Y2, Y3) I 2 solenoid valves Y1, Y2 (retrofittable: Y3) J 2 solenoid valves Y1, Y3 (retrofittable: Y2) L 3 solenoid valves Y1, Y2, Y3 V 1 solenoid valve Y1 (retrofittable: Y2, Y3), logic NOT-element X 2 solenoid valves Y1, Y2 (retrofittable: Y3), logic NOT-element Y 3 solenoid valves Y1, Y2, Y3, logic NOT-element
16	Feedback 2 2 feedbacks 3 2 feedbacks with external proximity switch
17	Type of interface B 24 V DC, 3-wire, PNP N 24 V DC, 3-wire, NPN C 48–130 V AC
18	Solenoid valve A 24 V DC, 0.85 W 0 Without
19	Screw connection M Metric air connection, M20×1.5 cable gland Z Inch air connection, 0.5" NPT cable gland J Metric air connection, 5-pin M12 plug (1 solenoid valve, 2 feedbacks) P Inch air connection, 5-pin M12 plug (1 solenoid valve, 2 feedbacks) H Metric air connection, 8-pin M12 plug (> 1 solenoid valve, > 2 feedbacks) I Inch air connection, 8-pin M12 plug (> 1 solenoid valve, > 2 feedbacks) B Inch air connection, Brad Harrison 0.5" NPT 5-pin plug (US)
	Options (multiple selection possible) /18 Supply air throttle: regulates the opening speed of the valve /19 Exhaust air throttle: regulates the closing speed of the valve /22 5-pin M12 connection socket for screw fitting J, P (article no. 508-963) 8-pin M12 connection socket for screw fitting H, I (article no. 508-061) /67 Protection class IP67 (temporary immersion) /69k Protection class IP69k (high pressure spray down) /UC Certification UL/CSA

The code is composed as following, depending on the chosen configuration:

Position	14	15	16	17	18	19	Options									
Code	TM15															



Technical data of the standard version		
Position detection	Sensors	
Housing material	PA 12/L	
Ambient temperature	-20 to +60 °C	
Air supply	Pressure range	2 to 8 bar
	Standard	acc. to ISO 8573-1:2010
	Solid content	Quality class 6
	Water content	Quality class 4
	Oil content	Quality class 3
Dimensions of air connections	Metric 6/4 mm, inch 6.35/4.31 mm (1/4")	
Protection class	IP66 (powerful water jet)	
Sound pressure level via exhaust air throttle	Max. 72 dB	
Visualization	LED (green, yellow)	
Certificates (optional)		• CSA C22.2
		• UL 429

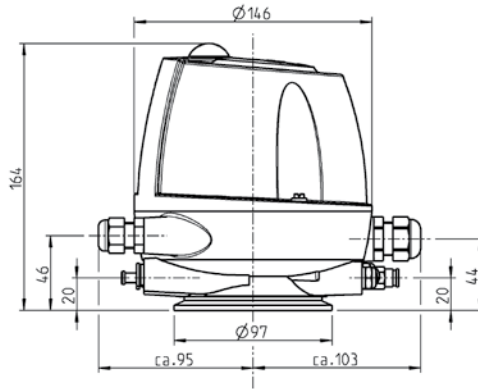

Type of interface	AS-Interface bus	DeviceNet
Supply		
Operating voltage	25.0–31.6 V DC	21–26 V DC
No-load current	≤ 62 mA	≤ 58 mA (at 24 V DC)
Maximum current consumption	225 mA	235 mA
Polarity reversal protection	Yes	Yes
Specification	AS-i V2.11 (max. 62 slaves with master V2.11)	ODVA-compliant
Additional information	IO.ID.ID2-code: 7.A.E	EDS file: F1022_R4.eds
Certificate	AS-i association/ cCSAus	ODVA
Inputs		
Feedback "start position"	Data bit DI 0	Data bit I-0
Feedback "end position"	Data bit DI 1	Data bit I-1
Feedback "seat lift position" (ext. NI)	Data bit DI 2	Data bit I-2
Collective fault		Data bit I-7
Outputs		
Activation "PV Y1"	Data bit DO 0	Data bit O-0
Activation "PV Y2"	Data bit DO 1	Data bit O-1
Activation "PV Y3"	Data bit DO 2	Data bit O-2

Position	Description of the order code
14	Feedback location TM15 Control top T.VIS® M-15
15	Control top type N Without solenoid valve P 1 solenoid valve Y1 M 1 solenoid valve Y1 (retrofittable: Y2, Y3) I 2 solenoid valves Y1, Y2 (retrofittable: Y3) J 2 solenoid valves Y1, Y3 (retrofittable: Y2) L 3 solenoid valves Y1, Y2, Y3 V 1 solenoid valve Y1 (retrofittable: Y2, Y3), logic NOT-element X 2 solenoid valves Y1, Y2 (retrofittable: Y3), logic NOT-element Y 3 solenoid valves Y1, Y2, Y3, logic NOT-element
16	Feedback 2 2 feedbacks 3 2 feedbacks with external proximity switch
17	Type of interface A AS-Interface bus D DeviceNet
18	Solenoid valve A 24 V DC, 0.85 W 0 Without
19	Screw connection A Metric air connection M20×1.5 cable gland with connection box on cable 1 m (AS-i) S Inch air connection M20×1.5 cable gland with connection box on cable 1 m (AS-i) L Metric air connection, 2-pin M12 plug (AS-i) U Inch air connection, 2-pin M12 plug (AS-i) D Metric air connection, 5-pin M12 plug (DeviceNet) K Inch air connection, 5-pin M12 plug (DeviceNet)
	Options (multiple selection possible) /18 Supply air throttle: regulates the opening speed of the valve /19 Exhaust air throttle: regulates the closing speed of the valve /22 5-pin M12 connection socket for screw fitting L, U, D, K (A-coded, article no. 508-963) /67 Protection class IP67 (temporary immersion) /69k Protection class IP69k (high pressure spray down) /81 AS-i connection box on cable 1 m with M12 connection socket (article no. 508-027) for screw fitting L, U /82 AS-i connection box on cable 2 m with M12 connection socket (article no. 508-028) for screw fitting L, U /UC Certification UL/CSA

The code is composed as following, depending on the chosen configuration:

Position	14	15	16	17	18	19	Options									
Code	TM15															

Concept

The T.VIS® A-15 is equipped with a high-precision path measuring system. This automatic open/close position recognition is available on any valve from GEA Tuchenhagen, along with a T.VIS® feedback system.

Development has focussed on the requirements and necessities of our customers from the fluid-processing industry. In addition to safe control and monitoring of all functions of the process valves in breweries, dairies, plants for manufacturing fruit juices as well as pharmaceuticals, the T.VIS® A-15 offers significant advantages that are directly reflected in lower total cost of ownership.

Standard variant



- 1 Pneumatic block
- 2 Control unit
- 3 Path measuring system
- 4 Solenoid valves
- 5 LED lighting
- 6 2 push buttons
- 7 Central compressed air connection with replaceable filter
- 8 M12 plug connection
- 9 Logic NOT-element

Features
Quick, automatic initialization
Tamper-proof setting of tolerances
Reduced energy consumption
Reduction in operating costs
Valve status display by LED
Basic LED colors can be selected specifically for the customer
Filter protects solenoid valves
High-quality pneumatic fittings
Exchangeable compressed air connection
Supply and exhaust air throttles can be fitted
Logic NOT-element
LEFF® function
Semi-automatic setup
Standard protection class IP66

Structure

The T.VIS® A-15 is equipped with a precise path measuring system for detecting its position.

The necessary wiring for control and feedback is performed, depending on the requirements, via the M12 plug connections accessible from the outside or through direct wiring and cable glands.

The control top can be opened for this.

Operation and configuration of the T.VIS® A-15 takes place either by the two push buttons on the cap or, with the cap removed, via the buttons below. The push buttons are secured electronically against inadvertent or incorrect operation, while in operating mode.

A replaceable filter, in the supply air connection, protects the solenoid valves.

Position detection

Path measuring system – the valve position is registered by means of a highly modern path measuring system.

Setting

Automatic – following unlocking, simply pressing the two buttons on the cap of the T.VIS® A-15 starts the initialization process which runs fully automatically. There is no need to open the control top for this purpose, resulting in particularly quick, easy and safe commissioning of the control top (on average < 1 minute).

Immediately following the set-up, it is possible to set the open/close position tolerances and signal attenuation in the parameter menu.

Logic NOT-element

A logic NOT-element is an available option. It simplifies wiring with automatic air support of the spring in the actuator, in order to increase the holding force of the valve.

For more information about the logic NOT-element, refer to the end of this section.

LEFF® function

LEFF® (Low Emission Flip Flop) is available in double-seat valves for each lifted and monitored valve disc. The function describes modulation of the valve disc during the lifting process to reduce the consumption of cleaning agent.

For more information about the LEFF® function, refer to the end of this section.

Semi-automatic setup

As a new feature, our control top T.VIS® A-15 has the option of semi-automatic setup that permits uncomplicated exchange in the current process.

For more information about the semi-automatic setup, refer to the end of this section.

Visualization

LED display:

- Green
- Yellow
- Red



Protection class IP66

The programmable color change allows the display of colors yellow and green to be swapped over.

Service mode

Activation of the main stroke which may be required in VARIVENT® and ECOVENT® valves with open non-actuated position for valve maintenance is performed using the service mode which can be activated by the buttons. At the same time, all feedbacks are stopped (warning to the system control). Furthermore, input signals from the control room are not implemented by the T.VIS®, in order to protect the employee.



Technical data of the standard version		
Position detection	Path measuring system	
Housing material	PA 12/L	
Ambient temperature	-20 to +60 °C	
Air supply	Pressure range	2 to 8 bar
	Standard	acc. to ISO 8573-1:2010
	Solid content	Quality class 6*
	Water content	Quality class 4
	Oil content	Quality class 3
Dimensions of air connections	Metric 6/4 mm, inch 6.35/4.31 mm (1/4")	
Protection class	IP66 (powerful water jet)	
Sound pressure level via exhaust air throttle	Max. 72 dB	
Visualization	LED (green, yellow, red)	
Certificates (optional)		• CSA C22.2
		• UL 61010-1

* Recommended

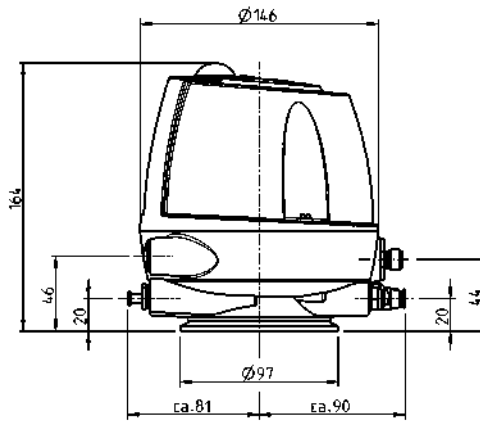

Type of interface	24 V DC, 3-wire, PNP	AS-Interface bus	DeviceNet
Supply			
Operating voltage	24 V DC (+20 %, -12.5 %)	26.5–31.0 V DC	11**–26 V DC
No-load current	≤ 25 mA	≤ 25 mA	≤ 35 mA
Maximum current consumption	265 mA	65 mA*	75 mA
Polarity reversal protection	Yes	Yes	Yes
Specification		AS-i V3.0 (max. 62 slaves)	
Additional information		IO.ID.ID2-code: 7.A.E.	
Certificate		AS-i association	ODVA

Inputs			
Connection type	24 V DC (PNP)		
Short circuit-proof	Yes		
Overload-proof	Yes		
Maximum current carrying capacity per feedback output	100 mA		
Voltage drop on the outputs	≤ 1 V		
Feedback "start position"	Electronic output	Data bit DI 0	Data bit I-0
Feedback "end position"	Electronic output	Data bit DI 1	Data bit I-1
Feedback "seat lift position"	Electronic output	Data bit DI 2	Data bit I-2

Outputs			
Activation voltage	> 13 V = high; < 6 V = low		
Current consumption per input	< 10 mA		
Activation "PV Y1"	Electronic input	Data bit DO 0	Data bit O-0
Activation "PV Y2"	Electronic input	Data bit DO 1	Data bit O-1
Activation "PV Y3"	Electronic input	Data bit DO 2	Data bit O-2

* This value is valid only with an activated solenoid valve. ** This value is valid for a control top without solenoid valve.

Position	Description of the order code
14	Feedback location TA15 Control top T.VIS® A-15
15	Control top type N Without solenoid valve P 1 solenoid valve Y1 I 2 solenoid valves Y1, Y2 (Y2 for lower seat lift) J 2 solenoid valves Y1, Y3 (Y3 for upper seat lift, air/air actuator or external process valve) L 3 solenoid valves Y1, Y2, Y3 V 1 solenoid valve Y1, logic NOT-element X 2 solenoid valves Y1, Y2, logic NOT-element Y 3 solenoid valves Y1, Y2, Y3, logic NOT-element
16	Feedback 8 2 digital feedbacks 9 2 digital feedbacks with external proximity switch
17	Type of interface A AS-Interface BUS B 24 V DC PNP D DeviceNet
18	Solenoid valve A 24 V DC, 0.85 W 0 Without
19	Screw connection J Metric air connection, 5-pin M12 plug for 24 V DC (1 PV, 2 feedbacks), AS-i, DeviceNet P Inch air connection, 5-pin M12 plug for 24 V DC (1 PV, 2 feedbacks), AS-i, DeviceNet H Metric air connection, 8-pin M12 plug for 24 V DC (> 1 solenoid valve, > 2 feedbacks) I Inch air connection, 8-pin M12 plug for 24 V DC (> 1 solenoid valve, > 2 feedbacks) M Metric air connection, M20×1,5 cable gland with integrated terminal strip Z Inch air connection, 0.5" NPT cable gland with integrated terminal strip
	Options (multiple selection possible) /18 Supply air throttle: regulates the opening speed of the valve /19 Exhaust air throttle: regulates the closing speed of the valve /22 24 V DC/AS-i/DeviceNet: 5-pin connection socket for screw connection J, P (article no. 508-963) 24 V DC: 8-pin connection socket for screw fitting H, I (article no. 508-061) /67 Protection class IP67 (temporary immersion) /69k Protection class IP69k (high pressure spray down) /81 AS-i connection box on cable 1 m with 5-pin M12 connection socket (article no. 508-027) /82 AS-i connection box on cable 2 m with 5-pin M12 connection socket (article no. 508-028) /UC Certification UL/CSA

The code is composed as following, depending on the chosen configuration:

Position	14	15	16	17	18	19	Options									
Code	TA15															

Concept

As a controller based on the technology of the T.VIS® A-15 with path measuring system, the T.VIS® P-15 in combination with an air-spring actuator can move to any required valve position between the open/close positions.

The T.VIS® P-15 is characterized not only by its performance but also by its ease of operation and outstanding price/performance ratio.

Standard variant



- 1 Pneumatic block
- 2 Control unit
- 3 Path measuring system
- 4 Solenoid valves
- 5 LED lighting
- 6 2 push buttons
- 7 Exchangeable filter
- 8 M12 plug connection
- 9 Supply air throttle
- 10 Exhaust air throttle

Features
Automatic initialization
Simple and safe operation
Manual operation of the process valve
Valve status display by LED
Open/close position feedback (optional)
Selectable dead band (control hysteresis)
High-quality pneumatic fittings
High potential for cost reduction
Standard protection class IP66

Structure

The T.VIS® P-15 is equipped with a precise path measuring system for detecting its position.

The necessary wiring for control and feedback is configured using M12 plug connections that can be accessed externally.

The control top can be opened for this.

Operation and configuration of the T.VIS® P-15 takes place either by the two push buttons mounted on the cap or, with the cap removed, via the buttons below. The push buttons are secured electronically against inadvertent or incorrect operation, while in operating mode.

The T.VIS® P-15 is equipped as standard with adjustable supply and exhaust air throttles.

Position control

The T.VIS® P-15 position controller works with an integrated microprocessor which contains the software for operation, visualization as well as intelligent position detection and evaluation. When a nominal value is specified (4–20 mA), e.g. by the PLC, the process valve can be set to any required position. The push buttons on the cap also make it possible to specify a nominal value manually, in order to set the process valve to the required position. The position is detected using a position transducer and is automatically controlled using two integrated solenoid valves. The valve disc position can also be permanently evaluated using the analog actual value output, as well as, three binary outputs in the PLC.

Setting

Automatic – following unlocking, simply pressing the two buttons on the cap of the T.VIS® P-15 starts the initialization process which runs fully automatically. There is no need to open the position controller for this purpose, resulting in particularly quick, easy and safe commissioning of the position controller (on average in < 1 minute).

Directly following the set-up, the open/close position tolerances, the control hysteresis and control characteristics can be set in the parameter menu.



Visualization

LED display:

- Green
- Yellow
- Red
- Blue
- Blue flashing

Feedback

- Standard: valve position 0–100 %, opening amount (4–20 mA)
- Option: additionally 24 V DC feedback signals for open/close position and error output

Service mode

Activation of the main stroke which may be required in VARIVENT® and ECOVENT® valves with closed (non-actuated) position for valve maintenance is performed using service mode that can be activated by the buttons. At the same time, all feedbacks are stopped (warning to the system control). Furthermore, input signals from the control room are not implemented by the T.VIS®, in order to protect the employee.

Field of application

The T.VIS® P-15 can be used on VARIVENT® and ECOVENT® valves for controlling the valve disc position. Opening the valves to specific intermediate positions makes it possible to influence the hydraulic characteristics of the system. In N-valves, a control cone is available as an option which permits precise hydraulic setting.

Flow control

The T.VIS® P-15 position controller offers not only linear position signal transformation, but also the possibility of equal percentage position signal transformation. This permits significantly more precise position control of the valve disc in positions close to the non-actuated position.



Technical data of the standard version		
Position detection	Path measuring system	
Housing material	PA 12/L	
Ambient temperature	-20 to +60 °C	
Air supply	Pressure range	2 to 8 bar
	Standard	acc. to ISO 8573-1:2010
	Solid content	Quality class 6*
	Water content	Quality class 4
	Oil content	Quality class 3
Dimensions of air connections	Metric 6/4 mm, inch 6.35/4.31 mm (¼")	
Protection class	IP66 (powerful water jet)	
Sound pressure level via exhaust air throttle	Max. 72 dB	
Visualization	LED (green, yellow, red, blue)	

* Recommended

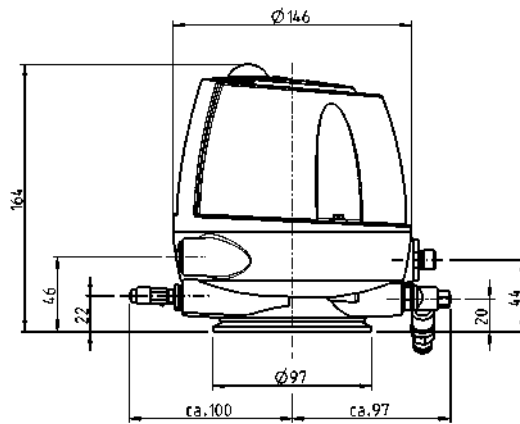

Type of interface	24 V DC programmable
Supply	
Supply voltage U_v	24 V DC (+20 %, -12.5 %)
No-load current	≤ 20 mA
Maximum current consumption	$\sum I = (I_{T.VIS} + I_{PV} + I_{RM}) = 260$ mA ± 10 %
Maximum residual ripple	5 %
Inputs	
Control voltage max. 28.8 V DC	High = ≥ 13 V DC Low = ≤ 6 V DC
Pilot current	≤ 10 mA
Outputs	
Output voltage	High = $U_v - \leq 5$ % Low = ≤ 5 V
Max. current	($\sum I_{RM}$) 200 mA short circuit-proof
Switching frequency	(ohmic + inductive loads ≤ 25 mH) 2 Hz
Operating current	Internal solenoid valve (I_{PV}) 35 ... 45 mA
Analog input	Setpoint 4–20 mA/0–100 % stroke
Analog output	Actual value 4–20 mA/0–100 % stroke
Load	Max. 600 Ω

Position	Description of the order code
14	Feedback location TP15 Control top T.VIS® P-15
15	Control top type I 2 solenoid valves
16	Feedback 4 T.VIS® P-15 (with analog module) 5 T.VIS® P-15 (with analog module + 2 feedbacks/error output)
17	Type of interface P 24 V DC programmable
18	Solenoid valve A 24 V DC, 0.85 W
19	Screw connection (with analog module) J Metric air connection, 5-pin M12 plug, A-coded With feedback code 5: additional M12 plug B-coded inclusive P Inch air connection, 5-pin M12 plug, A-coded With feedback code 5: additional M12 plug B-coded inclusive IMPORTANT: Please also order the appropriate connection sockets as well.
	Options (multiple selection possible) /22 5-pin connection socket for screw connection A-coded (article no. 508-963) 5-pin connection socket for screw connection B-coded (article no. 508-964) /67 Protection class IP67 (temporary immersion) /69k Protection class IP69k (high pressure spray down)

The code is composed as following, depending on the chosen configuration:

Position	14	15	16	17	18	19	Options			
Code	TP20	I		P	A					

Concept

The SES is characterized by proven sensor technology. The control top consists of an interface module, up to 2 sensors for valve position feedback and up to 3 solenoid valves which can also be installed subsequently.

The SES is only available in PA 12/L material, because conductivity of the material is required for use in ATEX/Ex areas.



- 2 Interface module
- 3 Proximity switches
- 4 Solenoid valves
- 8 Cable gland

Features

- Proven NAMUR sensors
- Simple and quick adjustment of sensors
- Flexible modular system
- Selection of various solenoid valves
- Retro-fittable

Position detection

Proximity switches – the valve positions are recorded using two manually adjustable proximity switches for the non-actuated and actuated position.

Setting

Mechanical – the sensors are calibrated mechanically using the positioning spindles, which are subsequently secured to prevent adjustment.

Field of application

Use in potentially explosive atmospheres is permitted:*

- **With proximity switch** up to zone 1 and 20**
 - For connection to approved intrinsically safe equipment
 - ATEX identification:
 - II 2G Ex ia IIC T6
 - II 1D Ex iaD 20 T97 °C
- **With solenoid valve up to zone 0 and 20**
 - For connection to approved intrinsically safe equipment
 - ATEX identification:
 - II 2G Ex ia IIC T6
- **With interface module**
 - Not subject to Ex approval because it is a purely passive component

Please note

- *) There is no ATEX certification for the complete control top. Certifications can only be issued for the individual components of the control top. Please note that the permitted Ex-zone/ATEX category of the complete control top depends on the approval of the component with the lowest protection level. The entire control top with all components is optionally certified according to:
- CSA C22.2
 - ANSI/ISA 82.02.01-1999
 - UL 1203, 4th Ed.
 - UL 429, 6th Ed.
 - ISA/ANSI 12.12.01-2011
- ***) The intrinsically safe components are only allowed to be individually connected to an approved safety barrier. This arrangement permits use in a risk area.

Visualization

The position of the switch bar projecting from the control top makes it possible to detect what the position of the valve is.





Technical data of the standard version		
Position detection	Inductive proximity switches	
Housing material	PA 12/L	
Ambient temperature	0 to 45 °C	
Air supply	Pressure range	1.5 bis 7 bar
	Standard	acc. to ISO 8573-1:2010
	Solid content	Quality class 6
	Water content	Quality class 4
	Oil content	Quality class 3
Dimensions of air connections	Metric 6/4 mm, inch 6.35/4.31 mm (¼")	
Protection class	IP65*	
Sound pressure level via exhaust air throttle	Max. 72 dB	
Visualization	Position of switch rod	
Certificates	 <ul style="list-style-type: none"> • II 2G EEx ia IIC T6** 	

* Not for overhead installation ** Standard for SES

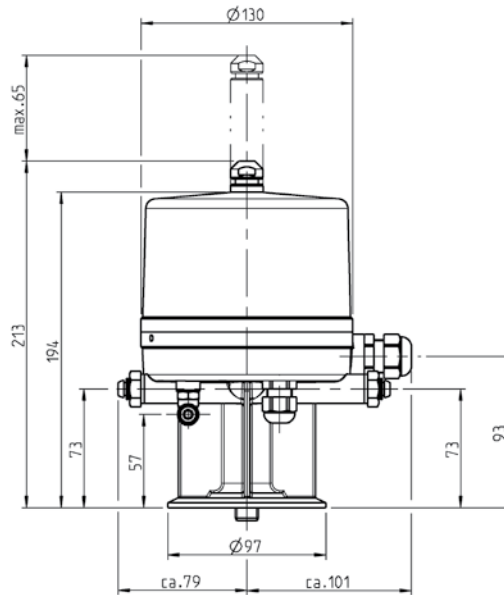

Type of interface	EEx / ATEX (12 V DC)	EEx / ATEX (24 V DC)
Sensor		
Communication	NAMUR 8.2 VDC (operating voltage 6–30 V DC)	NAMUR 8.2 VDC (operating voltage 6–30 V DC)
Equipment category	II 2G Eex ia IIC T6 and Ex iaD 20 T97 °C	II 2G Eex ia IIC T6 and Ex iaD 20 T97 °C
Article no.	505-093	505-093
Solenoid valve		
Rated voltage	12 V DC –10 % / +25 %	24 V DC –10 % / +15 %
Rated power	0.5 W	0.5 W
Equipment category	II 1GD Eex ia IIC T6	II 1GD Eex ia IIC T6
Article no.	512-124	512-155
Certificates (optional)	 <ul style="list-style-type: none"> • CSA C22.2 • ANSI/ISA 82.02.01-1999 • UL 1203, 4th Ed. • UL 429, 6th Ed. • ISA/ANSI 12.12.01-2011 	

Position	Description of the order code
14	Feedback location SES. Control top sensor technology
15	Control top type N Without solenoid valve P 1 solenoid valve Y1 I 2 solenoid valves Y1, Y2 L 3 solenoid valves Y1, Y2, Y3
16	Feedback 0 Without 1 1 feedback 2 2 feedbacks 3 2 feedbacks with external proximity switch
17	Type of interface E EEx/ATEX
18	Solenoid valve 0 Without E 12 V DC, ATEX X 24 V DC, ATEX
19	Screw connection E Metric air connection, Pg 13.5 cable gland N Inch air connection, Pg 13.5 cable gland
	Options (multiple selection possible) /43 Material PA 12/L: UV, oil and grease resistant (standard in control top SES) /UC Certification UL/CSA

The code is composed as following, depending on the chosen configuration:

Position	14	15	16	17	18	19	Options	
Code	SES.			E			/43	



Connection 0

Connection 0 can be used as an alternative to feedback systems if no feedback sensors are wanted above the actuator. Connection 0 is available in a metric and inch variant.

Technical data	
Material	AISI 304
Surface	Metal blank



INA – proximity switch holder on the actuator

The proximity switch holder M12x1 (INA) makes it possible to use feedback sensors above the actuator. The proximity switch holder has prepared M12x1 holes which allow the sensors to be set optimally. A direct connection to the controller provides the feedback on the valve position.

Technical data	
Material	AISI 304
Surface	Metal blank



LAT – lantern for 2 proximity switches M12x1

Feedback in the lantern is preferably used wherever control and feedback systems cannot be employed (e.g. in valves with manual actuator or two-position-stop cylinder).

Position	Description of the order code
14	Feedback location
	000 Connection 0 (without feedback)
	INA. Proximity switch holder for connection 0 for max. 2 proximity switches M12x1
	LAT. Lantern for max. 2 proximity switches M12x1
15	Control top type
	0 Connection 0
16	Feedback
	0 Without (INA, 000)
	1 1 feedback (INA, LAT)
	2 2 feedbacks (INA, LAT)
	3 3 feedbacks in the lantern (LAT)
	7 Without, prepared for 2 feedbacks in the lantern (LAT)
17	Type of switch
	0 Without (INA, LAT, 000)
	B NI 24 V DC 3-wire PNP M12x1 with terminal chamber (INA, LAT)
	F NI 24 V DC 2-wire M12x1 with terminal chamber (INA, LAT)
	E NI NAMUR M12x1 with terminal chamber (INA, LAT)
	X NI 24 V DC 3-wire NPN M12x1 with terminal chamber (INA, LAT)
	S NI 24 V DC 3-wire PNP M12x1 with plug connector (INA, LAT)
18	Cable connection
	0 Without
19	Air connection
	0 Without
	M Metric (article no. 221-140.02)
	Z Inch (article no. 2214-140.04)

The code is composed as following, depending on the chosen configuration:

Position	14	15	16	17	18	19
Code		0			0	

Proximity Switches

External proximity switches M12x1 for mounting on the actuator or in the lantern.



Technical data	
Nominal switching distance	2 to 4 mm
Protection class	IP 67
Operating voltage	10–30 V DC/NAMUR
Material	PA 12/L GF 30/VA
Permitted ambient temperature	–30 to 85 °C

Proximity switch M12x1 for INA, LAT	Article no.
2-wire (terminal chamber)	505-104
3-wire PNP (M12 plug)	505-088
4-wire NPN (Change with terminal chamber)	505-105

Technical data	
Nominal switching distance	4 mm
Operating voltage	7.5–30 V DC
Permitted ambient temperature	–20 bis 70 °C

Proximity switch M12x1 for T.VIS®	Article no.
NAMUR (M12 plug)	505-098

Technical data	
Nominal switching distance	2 mm
Operating voltage	8.2 V DC norm.
Permitted ambient temperature	–25 bis 70 °C

Proximity switch M12x1 for SES	Article no.
NAMUR (terminal chamber)	505-085

Switch bars and adapters

The following components are required for subsequent installation of a control and feedback system on a VARIVENT® or ECOVENT® valve.

If a complete control and feedback system is ordered, switch bar 221-589.80, 221-589.75 or 221-405.03 is already included. If an alternative switch bar is required, please state the corresponding part number or the valve provided.

Valve type		Control top				
		T.VIS® M-15	T.VIS® A-15	T.VIS® P-15	SES	
VARIVENT®		Switch bar				
Single-seat valves	N, U, W, X	221-589.80	221-589.75	221-589.75	221-405.03	
Mixproof seat valves	D, B, R, L, C, K, Y, T	221-589.80	221-589.75	-	221-405.03	
Mixproof seat valves with seat lifting	Axial sealing: D, B, Y	221-589.80	221-589.75	-	221-405.03	
	Radial sealing: R, L, T, 24/7 PMO valve® 2.0	Switch bar (depending on the particular actuator):				
		AA, BA, BB, BD, CA, CB, CD, CF	221-618.25	221-618.20	-	221-623.02
		BD (DN25), BD (PMO 2.0), BD5, BE, CE, CF5, DB, DD, DF, DG, DH, ED, EF, EG, EH	221-618.26	221-618.21	-	221-623.03
		DD5, DF5, DG5, ED5, EF5, EG5, EH5	221-618.27	221-618.22	-	221-623.04
		DF6Z	221-618.28	221-618.23	-	221-623.05
SG6Z, SH6Z, SK6Z, SM6Z, SN6Z, EF6Z, EG6Z, EH6Z, EK6Z, SG8A, SH6A, SK6A, SM6A, SN6A, EF6A, EG6A, EH6A, EK6A	221-618.29	221-618.24	-	221-623.09		
ECOVENT®		Switch bar/add-on parts				
Single-seat valves	N/ECO, W/ECO (DN 25 to DN 100)	Switch bar	221-589.80	221-589.75	221-589.75	221-405.03
		Ring	221-002396	221-002396	221-002396	221-643.08
		Mounting socket	221-589.32	221-589.32	221-589.32	221-589.32
	N/ECO, W/ECO (DN 10 and DN 15)	Switch bar	221-589.80	221-589.75	221-589.75	221-405.03
		Adapter	221-624.01	221-624.04	221-624.04	221-624.01
		Mounting socket	221-589.32	221-589.32	221-589.32	221-589.32



Switch bar 221-589.80 for T.VIS® M-15



Switch bar 221-589.75 for T.VIS® A-15/T.VIS® P-15



Extended switch bars for radial sealing double-seat valves with seat lifting: 221-618.25 for T.VIS® M-15 and 221-618.20 for T.VIS® A-15

Logic NOT-element

T.VIS® A-15 and T.VIS® M-15 control tops can optionally be equipped with a logic NOT-element. It simplifies wiring with optionally available automatic air support of the spring chamber in the actuator in order to increase the locking force of the valve, thus ensuring that it remains closed even at high product pressures, for example.

The logic NOT-element is linked to the solenoid valve Y1 (main stroke) of the particular control top and automatically channels the air supply to the spring side of the actuator as soon as solenoid valve Y1 for the main stroke is deactivated.

The pneumatic operating method of the logic NOT-element means there is no additional control complexity. In order for the logic NOT-element to be used, it is necessary for the installed actuator to be equipped with an air connection on the spring side (e.g. VARIVENT® Z actuators, ECOVENT® actuators).

To order a control top with logic NOT-element, select one of the following options in the order code under “control top type”:

- V – 1 solenoid valve and a NOT-element
- X – 2 solenoid valves and a NOT-element
- Y – 3 solenoid valves and a NOT-element

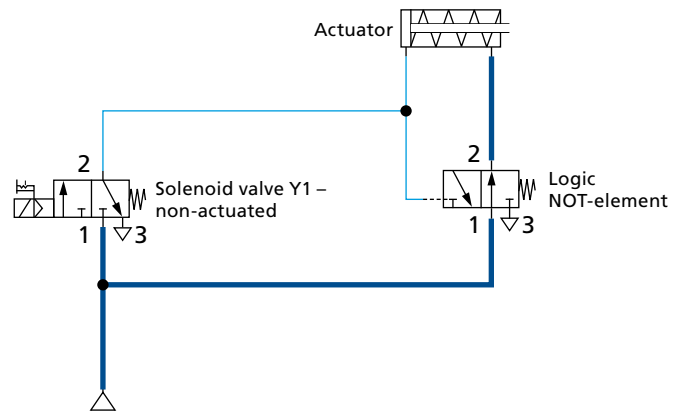

When the solenoid valve is closed, the logic NOT-element automatically directs the supporting air supply to the spring side of the actuator.

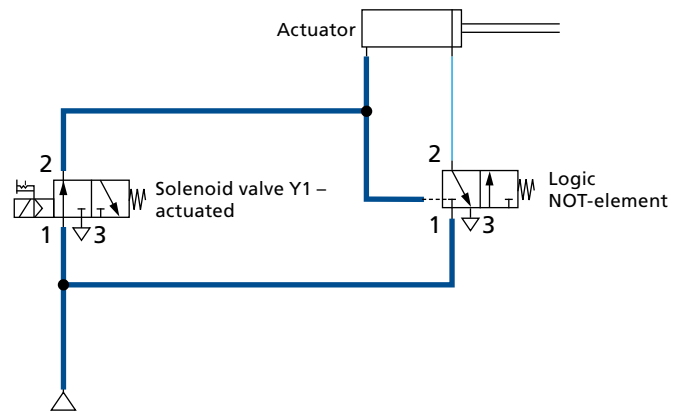

Activating the solenoid valve also activates the logic NOT-element pneumatically. The spring chamber is opened to the atmosphere and depressurized, causing the main stroke to take place.

IP protection classes

The IP protection classes inform about the scope at which the housing of an electrical device is protected against ingress of solids (first number) and moisture (second number).

So called IP-codes are assigned to the protected systems. Their index figures represent common error options against which the system is protected. The code starts with the letters IP for "International Protection".

Meaning of the index numbers

1. Index*	Protection from solids
6	Dust-tight
2. Index*	Protection from moisture
6	Protection from powerful water jet
7	Protection from temporary immersion
9k	Protection from water at high pressure/ steam jet cleaning

* Further indices and more precise explanations can be found in the corresponding standard.

If an index number is not to be stated, it is replaced by the letter x (e.g. IPx6).

For the 2nd index figure (protection from moisture), the following applies:

- The protection class IPx6 includes all protection classes below.
- **This does not apply to the higher protection class IPx7.** If this protection class is to include a lower protection class, this is to be indicated by a combination of index figures (e.g. IP67/69k).

The TVIS® control top designs of the M-15 and A-15 comply with the requirements of protection class IP66 (DIN EN 60529) as standard. Designs in the stronger protection classes IP67 or IP69k (both DIN EN 60529) are also available.

LEFF® function

LEFF® stands for Low Emission Flip Flop. The function describes modulation of the valve disc during the lifting procedure which is monitored by the path measuring system and the electronics of the T.VIS® A-15, and works independently from the process run times and product pressures.

The LEFF® function is automatically integrated in the T.VIS® A-15 and in double-seat valves it only uses the feedback units provided as standard, without needing any special components. The straightforward configuration using two push buttons on the T.VIS® cap allows the LEFF® function to be activated separately at any time during set-up for the valve or double disc. To allow the LEFF® function to be used with the double disc, it is necessary to have the optional external proximity switch.

Modulation of the valve disc during lifting makes it possible to reduce cleaning agent consumption and/or discharge into the drains by more than 90 % compared to the conventional lifting method, thereby drastically reducing operating costs. Even compared to modulation controlled in the PLC, the T.VIS® A-15 offers markedly lower CIP losses per cycle because of the significantly shorter data pathways, as well as the ability to register disc movement sooner internally because of the measuring system. Savings in the range from 30 % to 80 % are possible. However, these values are highly dependent on the process parameters, the level of contamination as well as the cleaning pressure and flow rate, as a result of which each CIP situation must be considered on a case-by-case basis.

Semi-automatic setup

By means of the semi-automatic setup, a control top can be replaced without interrupting the current process.

For this, an employee only needs to perform the simple configuration once on site: in the version in protection class IP66 with two push buttons on the T.VIS® cap, and for the optional protection classes IP67 and IP69k with the cap removed right with the two buttons below.



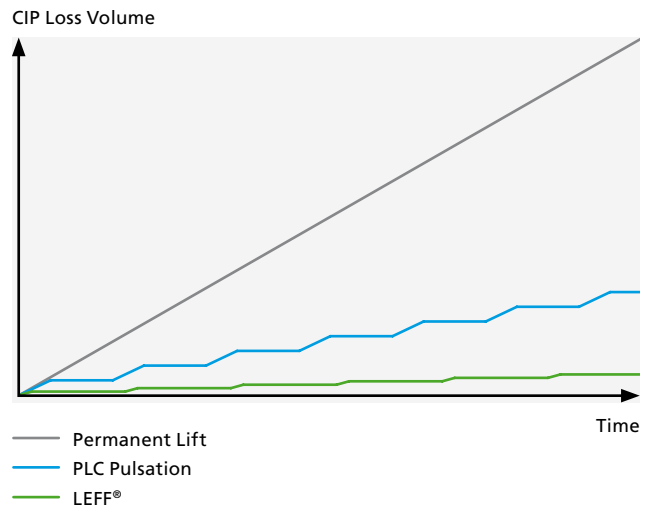







Features
No complicated programming required in the PLC
No additional system technology required
Independent from process run times and product pressures
Automatic monitoring of the lift functions
Significant cost reduction (CIP medium losses, waste water costs, etc.)



For the semi-automatic set-up, the control top initially only learns the position of the valve disc on the non-actuated position and then remains until the valve is actuated in the scope of a running process. Only then will the end position of the valve be stored. The process thus does not need to be stopped!

The semi-automatic set-up is integrated into the T.VIS® A-15 as standard and does not require any additional hardware. .

Connection Screw Fitting

	Order code for air connection		In conjunction with screw fitting or plug	Use	Matching connection socket		
	Metric	Inch			Option	Article no.	Designation
	M		M20x1.5 cable gland	T.VIS® M-15 T.VIS® A-15	-	-	-
	E		Pg 13.5 cable gland	SES	-	-	-
		Z	0.5" NPT cable gland	T.VIS® M-15 T.VIS® A-15	-	-	-
		N	Pg 13.5 cable gland	SES	-	-	-
	A	S	M20x1.5 cable gland with connection box on cable 1 m	T.VIS® M-15 (AS-i)	-	-	-
	L	U	2-pin M12-plug (A-coded)	T.VIS® M-15 (AS-i)	/22	508-963	5-pin M12 connection socket (A-coded)
					/81	508-027	AS-i connection box on cable 1 m with 5-pin M12 connection socket (A-coded)
					/82	508-028	AS-i connection box on cable 2 m with 5-pin M12 connection socket (A-coded)
	D	K	5-pin M12 plug (A-coded)	T.VIS® M-15 (DeviceNet)	/22	508-963	5-pin M12 connection socket (A-coded)
			5-pin M12 plug (B-coded)	T.VIS® M-15 (DeviceNet)		508-964	5-pin M12 connection socket (B-coded)
	J	P	5-pin M12-plug (A-coded)	T.VIS® M-15 (24 V DC) T.VIS® M-15 (48–130 V AC)	/22	508-963	5-pin M12 connection socket (A-coded)
				T.VIS® A-15 (24 V DC) T.VIS® A-15 (AS-i) T.VIS® A-15 (DeviceNet)			
			5-pin M12 plug (B-coded)	T.VIS® P-15		508-964	5-pin M12 connection socket (B-coded)
	H	I	8-pin M12-plug (A-coded)	T.VIS® M-15 (24 V DC) T.VIS® M-15 (48–130 V AC)	/22	508-061	8-pin M12 connection socket (A-coded)
				T.VIS® A-15 (24 V DC)			
		B	Brad Harrison 0.5" NPT 5-pin plug	T.VIS® M-15 (24 V DC) T.VIS® M-15 (48–130 V AC)	-	-	-

24 V (PNP/NPN)

In 24 V parallel wiring digital signals are exchanged between a terminal unit and generally the corresponding input and output modules of a PLC. In this case, it is necessary to have a separate wire for each signal, usually in the form of a multi-core cable.

PNP (current-supplying) indicates signal transfer against reference potential L₋.

NPN (current-drawing) indicates signal transfer against reference potential L₊.

BUS AS-Interface



AS-Interface (Actuator-Sensor Interface) is a standard in fieldbus communication that was developed for connecting actuators and sensors. This is to replace parallel wiring used in the past. The AS-Interface has been an international standard acc. to EN 50295 and IEC 62026-2 since 1999. AS-i products are certified by the AS International Association, thereby, ensuring that equipment from different manufacturers will work together in the same system. The transmission medium is an unshielded, two-core yellow cable which also carries the electrical power supply (24–30 V direct current voltage) for the communication electronics and the slaves. A maximum of 62 slaves can be used per AS-i master. The slaves are addressed manually using a manual addressing unit or automatically by the master. The maximum length of the AS-i cable is 100 m, although by using repeaters it is possible to extend the entire length up to 400 m.

DeviceNet bus

DeviceNet is a CAN-based fieldbus that is chiefly used in automation engineering. DeviceNet was developed by Allen-Bradley (part of Rockwell Automation) and later transferred to the ODVA (Open DeviceNet Vendor Association) as an open standard. DeviceNet is chiefly used in the USA and, to a certain extent, Asia. A maximum of 64 network nodes can be used per fieldbus segment. The nodes address is set either using dial or DIP switches on the device, or can be configured using the bus on the basis of software. The maximum length of the DeviceNet cable depends on the selected cable type and baud rate, although it cannot exceed 500 m.

48–130 V AC

This is also parallel wiring but with alternating current voltage signals that are processed in the control top using a wide-band I/O module. This communication technology is chiefly used in the United States and Canada with 110 V, although it can also be encountered in southern Europe with 48 V.

NAMUR









The 2-wire NAMUR sensors and solenoid valves used here can be operated in the Ex area because of their “intrinsically safe” ignition protection type. Using external isolating switching amplifiers, it is possible to operate control tops with this communication technology up to zone 1 or 21.

4–20 mA (3-wire)

In industrial automation engineering, the 4–20 mA current signal is the one most frequently used for analog measured value transmission. The enormously widespread use of this type of signal is explained by its ease of handling and, above all, its resistance to interference.

Using 4 mA as the initial value instead of 0 mA makes it very easy to detect and evaluate a wire break. As a rule, 4–20 mA corresponds to 0–100% of the physical measuring range of an analog sensor or the working range of an actuator set in the parameters; the nominal value is supplied or the actual value is returned via an interface of this kind.

Procedure for valve selection (positions 1 – 13), incl. a feedback system

Position	Description of the order code for the standard version			
1	Valve type			
	D VARIVENT® double-seat valve			
2	Housing combinations			
	A	B	C	E
				
3	Supplement to the valve type			
	L With lifting actuator and spray cleaning			
	C With lifting actuator without spray cleaning			
4/5	Nominal width (upper housing / lower housing)			
	DN 25	OD 1"		
	DN 40	OD 1 ½"		
	DN 50	OD 2"	IPS 2"	
	DN 65	OD 2 ½"		
	DN 80	OD 3"	IPS 3"	
	DN 100	OD 4"	IPS 4"	
	DN 125			
	DN 150	OD 6"	IPS 6"	
6	Actuator type			
	S Air/Spring			
7	Ruhelage			
	Z Spring-to-close (NC)			
8	Standard configuration with 6 bar supply air pressure for 5 bar product pressure			
	Actuator (spring-to-close)	/ Lifting actuator	For nominal widths	
	BA	/BLB	DN 25, OD 1"	
	BB	/BLB	DN 40, DN 50, OD 1 ½", OD 2", IPS 2"	
	CD	/CLB	DN 65, DN 80, OD 2 ½", OD 3", IPS 3"	
	DF	/DLB	DN 100, OD 4", IPS 4"	
	SH6	/EL6	DN 125	
	SK6	/EL6	DN 150, OD 6", IPS 6"	
9	Valve seat version (upper housing / lower housing)		Housing combination	
	L0	Loose seat ring/Clamp connection	A	B
			√	√
	V1	Welded seat ring/ Port orientation 90°		
	V2	Welded seat ring/ Port orientation 180°		
	V3	Welded seat ring/ Port orientation 270°		
10	Seal material in contact with the product			
	1 EPDM (FDA)			
	2 FKM (FDA)			
	3 HNBR (FDA); (up to DN 100, OD 4")			
11	Surface quality of the housing			
	1 Inside Ra ≤ 1.2 µm, outside matte blasted (IPS)			
	2 Inside Ra ≤ 0.8 µm, outside matte blasted (DN, OD)			
12	Connection fittings			
	N Welding end			
13	Accessories			
	/52 Adhesive ID tag			

Procedure for feedback system selection (positions 14–19)

Position	Description of the order code
14	Feedback location TM15 Control top T.VIS® M-15
15	Control top type N Without solenoid valve P 1 solenoid valve Y1 R 1 solenoid valve Y1 (retrofitable: Y2, Y3) I 2 solenoid valves Y1, Y2 (retrofitable: Y3) J 2 solenoid valves Y1, Y3 (retrofitable: Y2) L 3 solenoid valves Y1, Y2, Y3 V 1 solenoid valve Y1 (retrofitable: Y2, Y3), logic NOT-element X 2 solenoid valves Y1, Y2 (retrofitable: Y3), logic NOT-element Y 3 solenoid valves Y1, Y2, Y3, logic NOT-element
16	Feedback 2 2 feedbacks 3 2 feedbacks with external proximity switch
17	Type of interface B 24 V DC, 3-wire, PNP N 24 V DC, 3-wire, NPN C 48–130 V AC
18	Solenoid valve A 24 V DC, 0,85 W 0 Without
19	Screw connection M Metric air connection, M20x1.5 cable gland Z Inch air connection, 0.5" NPT cable gland J Metric air connection, 5-pin M12 plug (1 solenoid valve, 2 feedbacks) P Inch air connection, 5-pin M12 plug (1 solenoid valve, 2 feedbacks) H Metric air connection, 8-pin M12 plug (> 1 solenoid valve, > 2 feedbacks) I Inch air connection, 8-pin M12 plug (> 1 solenoid valve, > 2 feedbacks) B Inch air connection, Brad Harrison 0.5" NPT 5-pin plug (US)
	Options (multiple selection possible) /18 Supply air throttle: regulates the opening speed of the valve /19 Exhaust air throttle: regulates the closing speed of the valve /22 5-pin M12 connection socket for screw fitting J, P (article no. 508-963) 8-pin M12 connection socket for screw fitting H, I (article no. 508-061) /66 Protection class IP66 /67 Protection class IP67 /UC Certification UL/CSA

Example for a complete order code, comprising valve and feedback system:









Position	1	2	3	4/5	6	7	8	9	10	11	12	13	14 to 19					
Code	D	E	L	- DN 65/DN 65 -	S	Z	- CD/CLB -	LO	1	2	N	/52	+ TM15	L	2	B	A	M

The complete order code makes it possible to assemble an order code for a non-standard configuration. All possible options for the valve in question are included.

When ordering a valve, specify not only the order code but also any required connection fittings as well as the supply air and product pressure. Unless specific pressure values are stated, the actuators for valves will be configured for 6 bar air supply pressure and 5 bar product pressure.

Position	Description of the order code	Available for valve type			
		N	N/ECO	N/ECO small	U
1	Valve type				
	N VARIVENT® shut-off valve				
	N ECOVENT® shut-off valve (always with /ECO at position 3)				
	U VARIVENT® shut-off valve				
2	Housing combinations				
	L T	•	•	•	
	F* D*				•
	A B C E	•	•		•
3	Supplement to the valve type				
	/ECO ECOVENT® shut-off valve		•	•	
	V Long-stroke valve	•			•
	F Control cone equal percentage	•			
	J Control cone linear	•			
	A/S Bellows, stainless steel	•			
A/P Bellows, PTFE	•				
4/5	Nominal width (upper housing / lower housing)				
	DN 10, DN 15			•	
	DN 25, DN 40, DN 50, DN 65, DN 80, DN 100	•	•		•
	DN 125, DN 150	•			•
	OD 1", OD 1½", OD 2", OD 2½", OD 3", OD 4"	•	•		•
	OD 6"	•			•
IPS 2", IPS 3", IPS 4", IPS 6"	•			•	
6	Actuator type				
	S VARIVENT® actuator air/spring	•			•
	E ECOVENT® actuator air/spring		•	•	
	Z VARIVENT® actuator air/spring, air-assisted	•			•
	J VARIVENT® actuator air/air	•			•
	G Manual actuator with locking	•			•
	L VARIVENT® long-stroke actuator air/spring	•			
7	Non-actuated position				
	Z Spring-to-open (NC)	•	•	•	•
	A Spring-to-close (NO)	•	•	•	•
8	Actuator				
	The size of the actuator depends on the valve type and size, the air supply and product pressure as well as the closing direction of the valve. This information must be specified in the order. The options section contains configuration tables.			60/4	

* With housing connection flange U

Position	Description of the order code	Housing combination						Available for valve type				
		A	B	C	E	L	T	N	N/ECO	N/ECO small	U	
9	Valve seat version											
	L0 Loose seat ring/ Clamp connection	√	√	√	√	√**	√**	•	•		•	
	V0 Fixed vertical port					√	√	•	•	•		
	V1 Welded seat ring/ Port orientation 90°							•	•			
	V2 Welded seat ring/ Port orientation 180°							•	•			
V3 Welded seat ring/ Port orientation 270°							•	•				
10	Seal material											
	1 EPDM (FDA)							•	•	•	•	
	2 FKM (FDA)							•	•	•	•	
	3 HNBR (FDA); (up to DN 100, OD 4")							•	•	•	•	
4 FFKM (FDA)							•	•	•	•		
11	Surface quality of the housing											
	1 Inside Ra ≤ 1.2 µm, outside matte (standard with IPS)							•	•	•	•	
	2 Inside Ra ≤ 0.8 µm, outside matte (standard with DN and OD)							•	•	•	•	
	3 Inside Ra ≤ 0.8 µm, outside ground							•	•	•	•	
	4 Inside Ra ≤ 0.4 µm, outside matte							•	•	•	•	
	6 Inside Ra ≤ 0.5 µm, outside matte							•	•	•	•	
	7 Inside Ra ≤ 0.5 µm, outside ground							•	•	•	•	
	8 Inside Ra ≤ 0.4 µm, outside ground							•	•	•	•	
12	Connection fittings											
	N Welding end							•	•	•	•	
	J With connection fitting (please specify separately in each case)							•	•	•	•	
	TK VARIVENT® flange connection complete, groove flange on housing							•	•		•	
	TN VARIVENT® groove flange cpl., incl. O-ring and connecting parts							•	•		•	
	TF VARIVENT® smooth flange							•	•		•	
	GK Pipe fitting S complete, male end on housing							•	•	•	•	
	KO Liner including groove nut SD							•	•	•	•	
	GO Male end SC including sealing ring G							•	•	•	•	
	ASK Hygienic flange connection complete, groove flange on housing							•	•	•	•	
	NFK Hygienic-groove flange complete, incl. O-ring and connecting parts							•	•		•	
BFK Hygienic flange							•	•		•		
CO Clamp connection							•	•	•	•		

** For VARIVENT® type U, only the two housing combinations F and D with housing connection U are available.

Position	Description of the order code	Available for valve type			
		N	N/ECO	N/ECO small	U
13	Accessories				
	/E Electrolytically polished	•	•	•	•
	/12 Damping cylinder	•			•
	/16 Two-position-stop (cylinder)	•			•
	/20 Limit-stop opening	•			•
	/21 Limit-stop closing	•			•
	/24 Sterile lock complete	•			•
	/25 Jacketed valve housings	•	•		•
	/28 Lower housing port suitable for orbital welding	•	•		
	/37 PS 20 bar	•	•		•
	/41 Test report 2.2	•	•	•	•
	/42 Inspection certificate 3.1 acc. to EN 10204	•	•	•	•
	/T With housing connection T (in valves with housing combination D or F)	•	•		•
	/U With housing connection U (in valves with housing combination D or F)	•	•		•
	/50 Engraved metal plate	•	•	•	•
	/51 Metal plate USA	•	•	•	•
	/52 Adhesive ID tag	•	•	•	•
	/55 Cable carrier 10 characters	•	•	•	•
	/56 2 cable carriers 20 characters	•	•	•	•
	/3A Adhesive ID tag, version of the valve acc. to 3-A standard	•	•	•	•
	/TL Housing tangential left	•			•
/TR Housing tangential right	•			•	
/TT Housing tangential straight	•			•	
+					
14–19	Control and feedback system				
	00000M Without control and feedback system with air connection metric for air hose Ø 6/4 mm				
	00000Z Without control and feedback system with air connection inch for air hose Ø OD ¼" (6.35/4.35 mm)				
	The description of the order code for valves with control and feedback system is contained in section 9.				

Position	1	2	3	4/5	6	7	8	9	10	11	12	13	14 to 19				
Code				/													

The complete order code makes it possible to assemble an order code for a non-standard configuration. All possible options for the valve in question are included.

When ordering a valve, specify not only the order code but also any required connection fittings as well as the air supply and product pressure. Unless specific pressure values are stated, the actuators for valves will be configured for 6 bar air supply pressure and 5 bar product pressure.

Position	Description of the order code	Available for valve type			
		W	W/ECO	W/ECO small	X
1	Valve type				
	W VARIVENT® divert valve				
	W ECOVENT® divert valve (always with /ECO at position 3)				
2	X VARIVENT® divert valve				
	Housing combinations				
	K* P*	•	•	•	
	V O	•	•	•	
	W U X Y Z M N G	•	•		•
3	Supplement to the valve type				
	/ECO ECOVENT® divert valve		•	•	
	R Radial sealing divert valve	•			
4/5	V Long-stroke valve	•**			•**
	Nominal width (upper housing / lower housing)				
	DN 10, DN 15			•	
	DN 25, DN 40, DN 50, DN 65, DN 80, DN 100	•	•		•
	DN 125, DN 150	•			•
	OD 1", OD 1½", OD 2", OD 2½", OD 3", OD 4"	•	•		•
OD 6"	•			•	
6	IPS 2", IPS 3", IPS 4", IPS 6"	•			•
	Actuator type				
	S VARIVENT® actuator air/spring	•			•
	E ECOVENT® actuator air/spring		•	•	
	Z VARIVENT® actuator air/spring, air-assisted	•			•
	J VARIVENT® actuator air/air	•			•
G Manual actuator with locking	•			•	
7	L VARIVENT® long-stroke actuator air/spring	•			•
	Non-actuated position				
	Z Spring-to-close (NC)	•	•	•	•
8	A Spring-to-open (NO)	•	•	•	•
	Actuator				
	The size of the actuator depends on the valve type and size, the air supply and product pressure as well as the closing direction of the valve. This information must be specified in the order. The options section contains configuration tables.			60/4	

* The radial sealing divert valve type W_R is only available in these combinations.

** Only in nominal widths OD 2 ½", OD 3" and OD 4"

Position	Description of the order code												Available for valve type				
													W	W/ECO	W/ECO small	X	
9	Valve seat version		Housing combination														
			K	P	V	O	W	V	Z	U	M	N	G				
	L0	Loose seat ring/ Clamp connection	√	√	√	√	√	√	√	√	√	√	√	•	•		•
	V0	Fixed vertical port	√***	√***	√	√								•	•	•	
	V1	Welded seat ring/ Port orientation 90°												•***			
	V2	Welded seat ring/ Port orientation 180°											•***				
	V3	Welded seat ring/ Port orientation 270°											•***				
10	Seal material																
	1	EPDM (FDA)												•	•	•	•
	2	FKM (FDA)												•	•	•	•
	3	HNBR (FDA); (up to DN 100, OD 4")												•	•	•	•
11	Surface quality of the housing																
	1	Inside Ra ≤ 1.2 µm, outside matte (standard with IPS)												•	•	•	•
	2	Inside Ra ≤ 0.8 µm, outside matte (standard with DN and OD)												•	•	•	•
	3	Inside Ra ≤ 0.8 µm, outside ground												•	•	•	•
	4	Inside Ra ≤ 0.4 µm, outside matte												•	•	•	•
	6	Inside Ra ≤ 0.5 µm, outside matte												•	•	•	•
	7	Inside Ra ≤ 0.5 µm, outside ground												•	•	•	•
	8	Inside Ra ≤ 0.4 µm, outside ground												•	•	•	•
12	Connection fittings																
	N	Welding end												•	•	•	•
	J	With connection fitting (please specify separately in each case)												•	•	•	•
	TK	VARIVENT® flange connection cpl., groove flange on housing												•	•	•	•
	TN	VARIVENT® groove flange cpl., incl. O-ring and connecting parts												•	•	•	•
	TF	VARIVENT® smooth flange												•	•	•	•
	GK	Pipe fitting 5 complete, male end on housing												•	•	•	•
	KO	Liner including groove nut SD												•	•	•	•
	GO	Male end SC including sealing ring G												•	•	•	•
	ASK	Hygienic flange connection complete, groove flange on housing												•	•	•	•
	NFK	Hygienic-groove flange complete, incl. O-ring and connecting parts												•	•	•	•
BFK	Hygienic-collar flange												•	•	•	•	
CO	Clamp connection												•	•	•	•	

*** Only for the radial sealing divert valve type W_R, also possible with welded seat ring/port orientation 0°.



Position	Description of the order code	Available for valve type				
		W	W/ECO	W/ECO small	X	
13	Accessories					
	/E	Electrolytically polished	•	•	•	•
	/12	Damping cylinder	•			•
	/16	Two-position-stop (cylinder)	•			•
	/20	Limit-stop opening	•			•
	/21	Limit-stop closing	•			•
	/24	Sterile lock complete	•			•
	/25	Jacketed valve housings	•	•		•
	/28	Lower housing port suitable for orbital welding	•****	•****		
	/37	PS 20 bar	•	•		•
	/41	Test report 2.2	•	•	•	•
	/42	Inspection certificate 3.1 acc. to EN 10204	•	•	•	•
	/50	Engraved metal plate	•	•	•	•
	/51	Metal plate USA	•	•	•	•
	/52	Adhesive ID tag	•	•	•	•
	/55	Cable carrier 10 characters	•	•	•	•
	/56	2 cable carriers 20 characters	•	•	•	•
	/3A	Adhesive ID tag, version of the valve acc. to 3-A standard	•			•
	/TL	Housing tangential left	•			•
/TR	Housing tangential right	•			•	
/TT	Housing tangential straight	•	•	•	•	
	+					
14-19	Control and feedback system					
	00000M	Without control and feedback system with air connection metric for air hose Ø 6/4 mm				
	00000Z	Without control and feedback system with air connection inch for air hose Ø OD ¼" (6.35/4.35 mm)				
	The description of the order code for valves with control and feedback system is contained in section 9.					

**** Only for valve in the housing combinations K, V, P or O







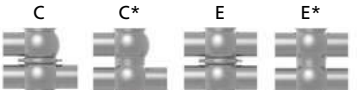

Position	1	2	3	4/5	6	7	8	9	10	11	12	13	14 to 19
Code				/									

The complete order code makes it possible to assemble an order code for a non-standard configuration. All possible options for the valve in question are included.

When ordering a valve, specify not only the order code but also any required connection fittings as well as the air supply and product pressure. Unless specific pressure values are stated, the actuators for valves will be configured for 6 bar air supply pressure and 5 bar product pressure. (7 bar product pressure with VARIVENT® type L).

Position	Description of the order code	Available for valve type						
		D	B	R	L	C	K	
1	Valve type							
	D VARIVENT® double-seat valve							
	B VARIVENT® double-seat valve with balancer							
	R VARIVENT® radial sealing double-seat valve							
	L VARIVENT® piggable double-seat valve							
	C VARIVENT® double-seat valve							
2	Housing combinations							
								
		•	•	•			•	
		•	•	•	•		•	
	Supplement to the valve type							
	/V Long-stroke	•**						
	H Suspended				•			
	S Upright				•			
	4/5	Nominal width (upper housing / lower housing)						
		DN 25	•		•		•	•
DN 40, DN 50		•		•	•	•	•	
DN 65, DN 80, DN 100		•	•	•	•	•	•	
DN 125, DN 150		•	•	•		•	•	
OD 1"		•		•		•	•	
OD 1 1/2", OD 2"		•		•	•	•	•	
OD 2 1/2", OD 3", OD 4"		•	•	•	•	•	•	
OD 6"		•	•	•			•	
IPS 2", IPS 3", IPS 4", IPS 6"		•	•	•			•	
6	Actuator type							
	S VARIVENT® actuator air/spring	•	•	•	•	•	•	
	Z VARIVENT® actuator air/spring, air-assisted	•	•	•	•	•	•	
	G Manual actuator with locking	•	•	•		•	•	
7	Non-actuated position							
	Z Spring-to-close (NC)	•	•	•	•	•	•	
8	Actuator							
	The size of the actuator depends on the valve type and size, the supply air and product pressure as well as the closing direction of the valve. This information must be specified in the order. The options section contains configuration tables.							

* Housing combination for piggable valves VARIVENT® type L
 ** Only in nominal widths OD 3" and OD 4"

Position	Description of the order code	Available for valve type					
		D	B	R	L	C	K
9	Valve seat version						
	L0 Loose seat ring/ Clamp connection	√	√	√	√	√***	√***
	V0 Fixed vertical port					√	√
	V1 Welded seat ring/ Port orientation 90°						
	V2 Welded seat ring/ Port orientation 180°						
	V3 Welded seat ring/ Port orientation 270°						
10	Seal material						
	1 EPDM (FDA)	•	•	•	•	•	•
	2 FKM (FDA)	•	•	•	•	•	•
	3 HNBR (FDA); (up to DN 100, OD 4")	•	•	•	•	•	•
	4 FFKM (FDA)	•	•	•	•	•	•
11	Surface quality of the housing						
	1 Inside Ra ≤ 1.2 µm, outside matte (standard with IPS)	•	•	•	•	•	•
	2 Inside Ra ≤ 0.8 µm, outside matte (standard with DN and OD)	•	•	•	•	•	•
	3 Inside Ra ≤ 0.8 µm, outside ground	•	•	•	•	•	•
	4 Inside Ra ≤ 0.4 µm, outside matte	•	•	•	•	•	•
	6 Inside Ra ≤ 0.5 µm, outside matte	•	•	•	•	•	•
	7 Inside Ra ≤ 0.5 µm, outside ground	•	•	•	•	•	•
	8 Inside Ra ≤ 0.4 µm, outside ground	•	•	•	•	•	•
12	Connection fittings						
	N Welding end	•	•	•	•	•	•
	J With connection fitting (please specify separately in each case)	•	•	•	•	•	•
	TK VARIVENT® flange connection complete, groove flange on housing	•	•	•	•	•	•
	TN VARIVENT® groove flange complete, incl. O-ring and connecting parts	•	•	•	•	•	•
	TF VARIVENT® smooth flange	•	•	•	•	•	•
	GK Pipe fitting S complete, male end on housing	•	•	•	•	•	•
	KO Liner including groove nut SD	•	•	•	•	•	•
	GO Male end SC including sealing ring G	•	•	•	•	•	•
	ASK Hygienic flange connection complete, groove flange on housing	•	•	•	•	•	•
NFK Hygienic-groove flange complete, incl. O-ring and connecting parts	•	•	•	•	•	•	
BFK Hygienic flange	•	•	•	•	•	•	
CO Clamp connection	•	•	•	•	•	•	







*** Only type K
 **** Only housing combination C and E

Position	Description of the order code	Available for valve type					
13	Accessories	D	B	R	L	C	K
	/E Electrolytically polished	•	•	•	•	•	•
	/12 Damping cylinder	•	•	•		•	•
	/23 Balancer flushing bottom		•	•			
	/24 Sterile lock complete	•	•	•		•	•
	/25 Jacketed valve housings	•	•	•			•
	/26 Leakage protection	•					
	/26 Leakage protection for balancer		•	•			
	/27 Version with only one flushing valve					•	
	/32 1 m CIP hose with connections	•	•	•	•	•	•
	/36 CIP connection blind for transport	•	•	•	•	•	•
	/37 Pressure level PS 20 bar	•	•	•			•
	/41 Test report 2.2	•	•	•	•	•	•
	/42 Inspection certificate 3.1 acc. to EN 10204	•	•	•	•	•	•
	/50 Engraved metal plate	•	•	•	•	•	•
	/51 Metal plate USA	•	•	•	•	•	•
	/52 Adhesive ID tag	•	•	•	•	•	•
	/55 Cable carriers 10 characters	•	•	•	•	•	•
	/56 2 cable carriers 20 characters	•	•	•	•	•	•
	/3A Adhesive ID tag, version of the valve acc. to 3-A standard	•	•	•	•		•
/K1 Straight leakage pipe						•	
/K2 90° leakage pipe						•	
+							
14-19	Control and feedback system						
	00000M Without control and feedback system with air connection metric for air hose Ø 6/4 mm						
	00000Z Without control and feedback system with air connection inch for air hose Ø OD ¼" (6.35/4.35 mm)						
The description of the order code for valves with control and feedback system is contained in section 9.							

Position	1	2	3	4/5	6	7	8	9	10	11	12	13	14 to 19				
Code				/													

The complete order code makes it possible to assemble an order code for a non-standard configuration. All possible options for the valve in question are included.

When ordering a valve, specify not only the order code but also any required connection fittings as well as the air supply and product pressure. Unless specific pressure values are stated, the actuators for valves will be configured for 6 bar air supply pressure and 5 bar product pressure. (7 bar product pressure with VARIVENT® type L).

Position	Description of the order code	Available for valve type				
		D	B	R	L	24/7 PMO
1	Valve type					
	D VARIVENT® double-seat valve					
	B VARIVENT® double-seat valve with balancer					
	R VARIVENT® radial sealing double-seat valve					
	L VARIVENT® piggable double-seat valve					
M 24/7 PMO valve 2.0						
2	Housing combinations					
	A  B 	•	•	•		•
	C  C*  E  E* 	•	•	•	•	•
3	Supplement to the valve type					
	C Lifting actuator without spray cleaning	•	•	•		•
	L Lifting actuator with spray cleaning	•	•	•		
	C/V Long-stroke valve with lifting actuator without spray cleaning	•**				
	L/V Long-stroke valve with lifting actuator and spray cleaning	•**				
	HC Suspended with lifting actuator without spray cleaning				•	
	HL Suspended with lifting actuator and spray cleaning				•	
	SC Upright with lifting actuator without spray cleaning				•	
SL Upright with lifting actuator and spray cleaning				•		
4/5	Nominal width (upper housing / lower housing)					
	DN 25	•		•		
	DN 40, DN 50	•		•	•	
	DN 65, DN 80, DN 100	•	•	•	•	
	DN 125, DN 150	•	•	•		
	OD 1"	•		•		•
	OD 1 ½", OD 2"	•		•	•	•
	OD 2 ½", OD 3", OD 4"	•	•	•	•	•
	OD 6"	•	•	•		•
	IPS 2", IPS 3", IPS 4", IPS 6"	•	•	•		
6	Actuator type					
	S VARIVENT® actuator air/spring	•	•	•	•	•
	Z VARIVENT® actuator air/spring, air-assisted	•	•	•	•	
G Manual actuator with locking	•	•	•			
7	Non-actuated position					
Z Spring-to-close (NC)	•	•	•	•	•	
8	Actuator					
The size of the actuator depends on the valve type and size, the air supply and product pressure as well as the closing direction of the valve. This information must be specified in the order. The options section contains configuration tables.						

* Housing combination for piggable valves VARIVENT® type L

** Only in nominal widths OD 3" and OD 4"

Position	Description of the order code					Available for valve type				
	Valve seat version		Housing combination			D	B	R	L	24/7 PMO
9			A	B	C	E				
	L0	Loose seat ring/ Clamp connection	✓	✓	✓	✓	•	•	•	
	V1	Welded seat ring/ Port orientation 90°					•	•	•	•***
	V2	Welded seat ring/ Port orientation 180°					•	•	•	•****
V3	Welded seat ring/ Port orientation 270°					•	•	•	•	
10	Seal material									
	1	EPDM (FDA)					•	•	•	•
	2	FKM (FDA)					•	•	•	•
	3	HNBR (FDA); (up to DN 100, OD 4")					•	•	•	•
11	Surface quality of the housing									
	1	Inside Ra ≤ 1.2 µm, outside matte (standard with IPS)					•	•	•	•
	2	Inside Ra ≤ 0.8 µm, outside matte (standard with DN and OD)					•	•	•	•
	3	Inside Ra ≤ 0.8 µm, outside ground					•	•	•	•
	4	Inside Ra ≤ 0.4 µm, outside matte					•	•	•	•
	6	Inside Ra ≤ 0.5 µm, outside matte					•	•	•	•
	7	Inside Ra ≤ 0.5 µm, outside ground					•	•	•	•
	8	Inside Ra ≤ 0.4 µm, outside ground					•	•	•	•
12	Connection fittings									
	N	Welding end					•	•	•	•
	J	With connection fitting (please specify separately in each case)					•	•	•	•
	TK	VARIVENT® flange connection complete, groove flange on housing					•	•	•	•
	TN	VARIVENT® groove flange compl., incl. O-ring and connecting parts					•	•	•	•
	TF	VARIVENT® smooth flange					•	•	•	•
	GK	Pipe fitting S complete, male end on housing					•	•	•	•
	KO	Liner including groove nut SD					•	•	•	•
	GO	Male end SC including sealing ring G					•	•	•	•
	ASK	Hygienic flange connection complete, groove flange on housing					•	•	•	•
	NFK	Hygienic-groove flange complete, incl. O-ring and connecting parts					•	•	•	•
BFK	Hygienic flange					•	•	•	•	
CO	Clamp connection					•	•	•	•	

*** Only housing combination C and E
 **** Only housing combination B

Position	Description of the order code		Available for valve type				
	D	B	R	L	24/7 PMO		
13	Accessories						
	/E	Electrolytically polished	•	•	•	•	•
	/12	Damping cylinder	•	•	•		•
	/23	Balancer flushing bottom		•	•		
	/24	Sterile lock complete	•	•	•		•
	/25	Jacketed valve housings	•	•	•		•
	/26	Leakage protection	•				
	/26	Leakage protection for balancer		•	•		
	/32	1 m CIP hose with connections	•	•	•	•	•
	/36	CIP connection blind for transport	•	•	•	•	•
	/37	Pressure level PS 20 bar	•	•	•	•	•
	/41	Test report 2.2	•	•	•	•	•
	/42	Inspection certificate 3.1 acc. to EN 10204	•	•	•	•	•
	/50	Engraved metal plate	•	•	•	•	•
	/51	Metal plate USA	•	•	•	•	•
	/52	Adhesive ID tag	•	•	•	•	•
	/55	Cable carrier 10 characters	•	•	•	•	•
/56	2 cable carriers 20 characters	•	•	•	•	•	
/3A	Adhesive ID tag, version of the valve acc. to 3-A standard	•	•	•	•	•	
14-19	Control and feedback system						
	00000M	Without control and feedback system with air connection metric for air hose Ø 6/4 mm					
	00000Z	Without control and feedback system with air connection inch for air hose Ø OD ¼" (6.35/4.35 mm)					
	The description of the order code for valves with control and feedback system is contained in section 9.						

Position	1	2	3	4/5	6	7	8	9	10	11	12	13	14 to 19
Code				/									

The complete order code makes it possible to assemble an order code for a non-standard configuration. All possible options for the valve in question are included.

When ordering a valve, specify not only the order code but also any required connection fittings as well as the air supply and product pressure. Unless specific pressure values are stated, the actuators for valves will be configured for 6 bar air supply pressure and 5 bar product pressure.

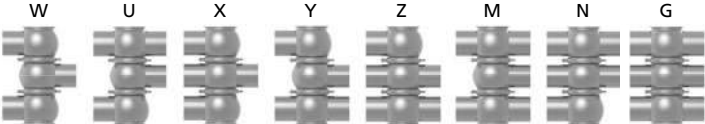
Position	Description of the order code
1	Valve type Y VARIVENT® double-seat valve with divert function
2	Housing combinations W U X Y Z M N G 
3	Supplement to the valve type C Lifting actuator without spray cleaning L Lifting actuator with spray cleaning
4/5	Nominal width (upper housing / lower housing) DN 25, DN 40, DN 50, DN 65, DN 80, DN 100, DN 125, DN 150 OD 1", OD 1½", OD 2", OD 2½", OD 3", OD 4", OD 6" IPS 2", IPS 3", IPS 4", IPS 6"
6	Actuator type S VARIVENT® actuator air/spring Z VARIVENT® actuator air/spring, air-assisted G Manual actuator with locking
7	Non-actuated position Z Spring-to-close (NC)
8	Actuator The size of the actuator depends on the valve type and size, the air supply and product pressure as well as the closing direction of the valve. This information must be specified in the order. The options section contains configuration tables.





Position	Description of the order code
9	Valve seat version L0 Loose seat ring/Clamp connection
10	Seal material 1 EPDM (FDA) 2 FKM (FDA) 3 HNBR (FDA); (up to DN 100, OD 4") 4 FFKM (FDA)
11	Surface quality of the housing 1 Inside Ra ≤ 1.2 µm, outside matte (standard with IPS) 2 Inside Ra ≤ 0.8 µm, outside matte (standard with DN and OD) 3 Inside Ra ≤ 0.8 µm, outside ground 4 Inside Ra ≤ 0.4 µm, outside matte 6 Inside Ra ≤ 0.5 µm, outside matte 7 Inside Ra ≤ 0.5 µm, outside ground 8 Inside Ra ≤ 0.4 µm, outside ground
12	Connection fittings N Welding end J With connection fitting (please specify separately in each case) TK VARIVENT® flange connection complete, groove flange on housing TN VARIVENT® groove flange complete, including O-ring and connecting parts TF VARIVENT® smooth flange GK Pipe fitting S complete, male end on housing KO Liner including groove nut SD GO Male end SC including sealing ring G ASK Hygienic flange connection complete, groove flange on housing NFK Hygienic-groove flange complete, including O-ring and connecting parts BFK Hygienic flange CO Clamp connection

Position	Description of the order code
13	Accessories
	/E Electrolytically polished
	/12 Damping cylinder
	/24 Sterile lock complete
	/25 Jacketed valve housings
	/26 Leakage protection
	/32 1 m CIP hose with connections
	/36 CIP connection blind for transport
	/37 Pressure level PS 20 bar
	/41 Test report 2.2
	/42 Inspection certificate 3.1 acc. to EN 10204
	/50 Engraved metal plate
	/51 Metal plate USA
	/52 Adhesive ID tag
	/55 Cable carrier 10 characters
/56 2 cable carriers 20 characters	
/3A Adhesive ID tag, version of the valve acc. to 3-A standard	
+	
14-19	Control and feedback system
	00000M Without control and feedback system with air connection metric for air hose Ø 6/4 mm
	00000Z Without control and feedback system with air connection inch for air hose Ø OD ¼" (6.35/4.35 mm)
The description of the order code for valves with control and feedback system is contained in section 9.	



The complete order code makes it possible to assemble an order code for a non-standard configuration. All possible options for the valve in question are included.

When ordering a valve, specify not only the order code but also any required connection fittings as well as the air supply and product pressure. Unless specific pressure values are stated, the actuators for valves will be configured for 6 bar air supply pressure and 5 bar product pressure.

Position	Description of the order code	Available for valve type			
		N	N/ECO	U	T_R
1	Ventiltyp				
	N VARIVENT® shut-off valve				
	N ECOVENT® shut-off valve (always with /ECO at position 3)				
	U VARIVENT® shut-off valve				
2	Housing combinations				
	L  T 				•*
	D*  F* 	•	•	•	•**
3	Supplement to the valve type				
	/ECO ECOVENT® shut-off valve		•		
	V Long-stroke valve	•		•	
	R Upper radial seat				•
	RC Upper radial seat, with lifting actuator without spray cleaning				•
4/5	Nominal width (upper housing/lower housing)				
	DN 25	•	•	•	•
	DN 40, DN 50, DN 65, DN 80, DN 100	•	•	•	•
	DN 125, DN 150	•	•	•	•
	OD 1"	•	•	•	•
	OD 1½", OD 2", OD 2½", OD 3", OD 4"	•	•	•	•
	OD 6"	•		•	•
	IPS 2", IPS 3", IPS 4", IPS 6"	•		•	•
6	Actuator type				
	S VARIVENT® actuator air/spring	•		•	•
	E ECOVENT® actuator air/spring		•		
	Z VARIVENT® actuator air/spring, air-assisted	•		•	•
	J VARIVENT® actuator air/air	•		•	
	G Manual actuator with locking	•		•	•
7	Non-actuated position				
	Z Spring-to-close (NC)	•	•	•	•
	A Spring-to-close (NO)	•	•	•	
8	Actuator				
	The size of the actuator depends on the valve type and size, the air supply and product pressure as well as the closing direction of the valve. This information must be specified in the order. The options section contains configuration tables.				

* Optionally with housing connection flange U or housing connection flange T

Position	Description of the order code					Available for valve type			
	Valve seat version		Housing combination			N	N/ECO	U	T_R
9	D	F	L	T					
	L0	Loose seat ring/ Clamp connection	√	√	√	√			
10	Seal material								
	1	EPDM (FDA)							
	2	FKM (FDA)							
	3	HNBR (FDA); (up to DN 100, OD 4")							
	4	FFKM (FDA)							
11	Surface quality of the housing								
	1	Inside Ra ≤ 1.2 µm, outside matte (standard with IPS)							
	2	Inside Ra ≤ 0.8 µm, outside matte (standard with DN and OD)							
	3	Inside Ra ≤ 0.8 µm, outside ground							
	4	Inside Ra ≤ 0.4 µm, outside matte							
	6	Inside Ra ≤ 0.5 µm, outside matte							
	7	Inside Ra ≤ 0.5 µm, outside ground							
	8	Inside Ra ≤ 0.4 µm, outside ground							
12	Connection fittings								
	N	Welding end							
	J	With connection fitting (please specify separately in each case)							
	TK	VARIVENT® flange connection complete, groove flange on housing							
	TN	VARIVENT® groove flange cpl., incl. O-ring and connecting parts							
	TF	VARIVENT® smooth flange							
	GK	Pipe fitting S complete, male end on housing							
	KO	Liner including groove nut SD							
	GO	Male end SC including sealing ring G							
	ASK	Hygienic flange connection complete, groove flange on housing							
	NFK	Hygienic-groove flange complete, incl. O-ring and connecting parts							
BFK	Hygienic flange								
CO	Clamp connection								

Position	Description of the order code		Available for valve type			
	N	N/ECO	U	T_R		
13	Accessories					
	/E	Electrolytically polished	•	•	•	•
	/12	Damping cylinder	•		•	•
	/16	Two-position-stop (cylinder)	•		•*	
	/20	Limit stop opening	•		•	
	/21	Limit stop closing	•		•	
	/24	Sterile lock complete	•	•	•	
	/25	Jacketed valve housings	•	•	•	•
	/32	1 m CIP hose with connections				•
	/36	CIP connection blind for transport				•
	/41	Test report 2.2	•	•	•	•
	/42	Inspection certificate 3.1 acc. to EN 10204	•	•	•	•
	/T	With housing connection T (in valves with housing combination D or F)	•	•	•	
	/U	With housing connection U (in valves with housing combination D or F)	•	•	•	
	/50	Engraved metal plate	•	•	•	•
	/51	Metal plate USA	•	•	•	•
	/52	Adhesive ID tag	•	•	•	•
	/55	Cable carrier 10 characters	•	•	•	•
/56	2 cable carriers 20 characters	•	•	•	•	
/3A	Adhesive ID tag, version of the valve acc. to 3-A standard	•	•	•	•	
/TL	Housing tangential left	•	•	•	•	
/TR	Housing tangential right	•	•	•	•	
/TT	Housing tangential straight	•	•	•	•	
14-19	Control and feedback system					
	00000M	Without control and feedback system with air connection metric for air hose Ø 6/4 mm				
	00000Z	Without control and feedback system with air connection inch for air hose Ø OD ¼" (6.35/4.35 mm)				
The description of the order code for valves with control and feedback system is contained in section 9.						

* Only with spring-to-open valves (NO)













Position	1	2	3	4/5	6	7	8	9	10	11	12	13	14 to 19
Code				/									

The complete order code makes it possible to assemble an order code for a control and feedback system. All options possible for the particular control or feedback system are included.

Position	Description of the order code	Available for control and feedback system						
		TM15	TA15	TP15	SES	000	INA	LAT
14	Feedback location							
	TM15 Control top T.VIS® M-15							
	TA15 Control top T.VIS® A-15							
	TP15 Control top T.VIS® P-15							
	SES. Control top sensor technology							
	000 Connection 0							
	INA. Proximity switch mount for connection 0 for 2x proximity switches M12x1							
	LAT. Lantern for 2x proximity switches M12x1							
15	Control top type							
	0 Connection 0					•		
	N Without solenoid valve	•	•		•			
	P 1 solenoid valve Y1	•	•		•			
	R 1 solenoid valve Y1 (for T.VIS® M-15 retrofittable: Y2, Y3)	•						
	I 2 solenoid valves Y1, Y2 (for T.VIS® M-15 retrofittable: Y3)	•	•	•	•			
	J 2 solenoid valves Y1, Y3 (for T.VIS® M-15 retrofittable: Y2)	•	•					
	L 3 solenoid valves Y1, Y2, Y3	•	•		•			
	V 1 solenoid valve Y1 (for T.VIS® M-15 retrofittable: Y2, Y3), logic NOT-element	•	•					
	X 2 solenoid valves Y1, Y3 (for T.VIS® M-15 retrofittable: Y2), logic NOT-element	•	•					
Y 3 solenoid valves Y1, Y2, Y3, logic NOT-element	•	•						
16	Feedback							
	0 Without feedback				•	•	•	
	1 1 feedback				•	•	•	
	2 2 feedbacks	•			•	•	•	
	3 2 feedbacks with external proximity switch	•			•		•	
	4 T.VIS® P-15 (with analog module)			•				
	5 T.VIS® P-15 (with analog module + 2 feedbacks/error output)			•				
	7 Without (prepared for 2 feedbacks in the lantern)							•
	8 2 digital feedbacks		•					
	9 2 feedbacks with external proximity switch		•					
17	Actuator type							
	0 Without					•	•	•
	A AS-Interface Bus	•	•				•	•
	B 24 V DC, 3-wire, PNP	•	•					
	C 48–130 V AC	•						
	D DeviceNet	•	•					
	E EEx/ATEX				•			
	E NI NAMUR M12x1 with terminal chamber						•	•
	F NI 24 V DC 2-wire M12x1 with terminal chamber						•	•
	N 24 V DC, 3-wire, NPN	•						
	P 24 V DC programmable			•				
	S NI 24 V DC 3-wire PNP M12x1 with plug connector						•	•
	X NI 24 V DC 3-wire NPN M12x1 with terminal chamber						•	•

Position	Description of the order code	Available for control and feedback system						
		TM15	TA15	TP15	SES	000	INA	LAT
18	Solenoid valve							
	0 Without	•	•		•	•	•	•
	A 24 V DC, 0,85 W	•	•	•				
	E 12 V DC, ATEX				•			
	X 24 V DC, ATEX				•			
19	Screw fitting					•	•	•
	0 Without					•	•	•
	A Metric air connection M20×1.5 cable gland with connection box on cable 1 m (AS-i)	•						
	B Inch air connection, Brad Harrison 0.5" NPT 5-pin plug (US)	•						
	D Metric air connection, 5-pin M12 plug (DeviceNet)	•						
	H Metric air connection, 8-pin M12 plug (> 1 solenoid valve, > 2 feedbacks)	•	•					
	I Inch air connection, 8-pin M12 plug (> 1 solenoid valve, > 2 feedbacks)	•	•					
	J Metric air connection, 5-pin M12 plug (1 solenoid valve, 2 feedbacks)	•	•	•				
	K Inch air connection, 5-pin M12 plug (DeviceNet)	•						
	L Metric air connection, 2-pin M12 plug (AS-i)	•						
	M Metric air connection M20×1.5 cable gland	•	•		•	•	•	•
	U Inch air connection, 2-pin M12 plug (AS-i)	•						
	P Inch air connection, 5-pin M12 plug (1 solenoid valve, 2 feedbacks)	•	•	•				
	S Inch air connection M20×1.5 cable gland with connection box on cable 1 m (AS-i)	•						
Z Inch air connection, 0.5" NPT cable gland	•	•		•	•	•	•	
	Options							
	/18 Supply air throttle: regulates the opening speed of the valve	•	•					
	/19 Waste air throttle: regulates the closing speed of the valve	•	•					
	/22 5-pin M12 connection socket for screw fitting, A-coded	•	•	•				
	/22 5-pin M12 connection socket for screw fitting, B-coded			•				
	/66 Protection class IP66	•	•	•				
	/67 Protection class IP67	•	•	•				
	/69k Protection class IP69k	•	•	•				
	/81 AS-i connection box on cable 1 m with M12 connection socket for screw fitting L, U	•	•					
	/82 AS-i connection box on cable 2 m with M12 connection socket for screw fitting L, U	•	•					
	/UC Certification UL/CSA	•	•		•			

Position	14	15	16	17	18	19	Options												
Code																			

3-A		3-A Sanitary Standards, Inc. (3-A SSI) is an independent, non-profit corporation dedicated to advancing hygienic equipment design for the food, beverage, and pharmaceutical industries.
24/7 PMO VALVE 2.0® NON-STOP PRODUCTION		24/7 PMO VALVE® is a registered trade mark of GEA Tuchenhagen GmbH. It describes double-seat valves that have been authorized for use in PMO-regulated systems for carrying out the seat lift in order to clean the leakage chamber while the other pipeline is carrying product. This grants system operators the possibility of cleaning all valve components in contact with the product in parallel with the production process. In this way, the valves permit uninterrupted production on a 24/7 basis.
AS-i		Actuator Sensor interface. BUS system for the lowest field level.
ATEX		Atmosphères Explosibles. ATEX comprises the directives of the European Union in the area of explosion protection. For one thing, this is the ATEX equipment directive 94/9/EC, for another, the ATEX workplace directive 1999/92/EC.
cCSAus		Test of a product by CSA according to applicable safety standards in Canada and the USA.
CE		Conformité Européenne. By affixing the CE mark, the manufacturer confirms that the product complies with the European directives applicable to the specific product.
CSA		Canadian Standards Association. A non-governmental Canadian organization which issues standards as well as checking and certifying the safety of products. It is now globally active.
cULus		Test of a product by UL according to applicable safety standards in Canada and the USA.
DeviceNet		BUS system of the ODVA organization for complex communication on various field levels.
EG 1935/2004		Materials in contact with the product used in valves from GEA Tuchenhagen GmbH are in accordance with EC regulation 1935/2004. This defines a general framework for materials and objects intended to come into contact with foodstuffs.
EHEDG		European Hygienic Engineering & Design Group. European supervisory authority for foodstuffs and pharmaceuticals. This authority issues approvals and certificates for products and materials that are used in the foodstuffs and pharmaceuticals industries.
FDA		Food and Drug Administration. US supervisory authority for foodstuffs and pharmaceuticals. This authority issues approvals and certificates for products and materials that are used in the foodstuffs and pharmaceuticals industries.
ODVA		ODVA is a worldwide association comprising leading automation companies. It develops network protocols and standards in the joint interests of its members, which are used for the international interoperability of production systems.
TÜV		Technischer Überwachungs-Verein. The German TÜV is a private company which carries out technical safety checks as prescribed in national legislation or regulations.
UL		Underwriters Laboratories. An organization founded in the USA for checking and certifying products and their safety.

Abbreviation	Explanation
°C	Degrees Celsius, unit of measurement for temperature
°F	Degrees Fahrenheit, unit of measurement for temperature
3-A	Standard of 3-A Sanitary Standards, Incorporated
3D	Three-dimensional
A	Ampere, unit of measurement of current intensity or Output, term used in automation
AC	Alternating Current
AISI	American Iron and Steel Institute, association of the American steel industry
ANSI	American National Standards Institute, American body for standardizing industrial processes
approx.	approximately
AS-i	Actuator Sensor interface, standard for fieldbus communication
ASME	American Society of Mechanical Engineers, professional association of mechanical engineers in the USA
ASME-BPE	Standard of the ASME's bioprocessing equipment association
ATEX	Atmosphères Explosibles, synonymous with the directives of the European Union for potentially explosive areas
bar	Unit of measurement for pressure. All pressure values [bar/psi] refer to positive pressure [bar _g /psi _g], unless specifically stated otherwise.
bar _g	Unit of measurement for pressure relative to atmospheric pressure
CAN	Controller Area Network; asynchronous serial bus system
CE	Conformité Européenne, administrative symbol for the free movement of industrial products
CIP	Cleaning In Place, designates a process for cleaning technical process systems.
CSA	Canadian Standards Association, a non-governmental Canadian Standardization organization
dB	Decibel, one tenth of a bel, named after Alexander Graham Bell and used for identifying levels and dimensions
DC	Direct Current
DIN	Deutsches Institut für Normung e. V. Standardization organization in the Federal Republic of Germany, DIN = synonym for standards issued by the organization
DIP	Dual Inline Package, design of a switch
DN	Diameter Nominal, DIN nominal width

Abbreviation	Explanation
E	Input, term used in automation
EHEDG	European Hygienic Engineering and Design Group. Consortium of equipment manufacturers, food industries, research institutes as well as public health authorities
EN	European standard, rules of the European Committee for Standardization
EPDM	Ethylene propylene diene rubber, acronym acc. to DIN/ISO 1629
Ex	Synonym for ATEX
FDA	Food and Drug Administration, official foodstuffs monitoring in the United States
FEM calculation	Finite Element Method; calculation process for simulating solids
FKM	Fluorinated rubber, acronym acc. to DIN/ISO 1629
H	Henry, unit of measurement for inductance
HNBR	Hydrated acrylonitrile butadiene rubber, acronym acc. to DIN/ISO 1629
Hz	Hertz, unit of frequency named after Heinrich Hertz
I	Formula symbol for electrical current
IEC	International Electrotechnical Commission, international standardization organization for electrical and electronic engineering
IP	Ingress Protection/International Protection, index of protection class acc. to IEC 60529
IPS	Iron Pipe Size, American pipe dimension
ISA	International Society of Automation, international US organization of the automation industry
ISO	International Organization for Standardization, international organization that produced international standards, ISO = synonym for standards from the organization
kg	Kilogram, unit of measurement for weight
Kv	The Kv value corresponds to the water flow rate through a valve (in m ³ /h) at a pressure differential of 0.98 bar and a water temperature of 5 °C to 30 °C.
Kvs	The Kv values of a valve at nominal stroke (100 % opening) is designated the Kvs value
L	Conductive
LED	Light-Emitting Diode
LEFF®	Function of the T.VIS® valve informations system for cyclical pulsing during the lifting process; Low-Emission Flip Flop
mm	Millimeter, unit of measurement for length

Abbreviation	Explanation
M	Metric, system of units based on the meter or Mega, one million times a unit
m ³ /h	Cubic meters per hour, unit of measurement for volumetric flow
max.	Maximum
NAMUR	Standardization working association for measuring and control technology in the chemical industry, synonym for the interface type of the organization, especially for potentially explosive atmospheres
NC	Normally Closed; valve or solenoid valve control which is closed in idle status
NO	Normally Open; valve or solenoid valve control which is open in idle status
NOT-Element	Logic element, NOT gate
NPN	Signal transmission against reference potential, current-consuming
NPT	National Pipe Thread, US thread standard for self-sealing pipe fittings
OD	Outside Diameter, pipe dimension
ODVA	Open DeviceNet Vendor Association, global association for network standards
PA 12/L	Polyamide
Pg	Armoured thread
PLC	Programmable Logic Controller, device for controlling a machine or system on a digital basis
PMO	Pasteurized Milk Ordinance
PN	Nominal pressure for pipeline systems according to EN 1333, rated pressure in bar at room temperature (20 °C)
PNP	Signal transmission against reference potential, current-supplying
PPO	Polyphenylene oxide, thermoplastic material
PS	Maximum permitted operating pressure at which the components can operate safely at maximum allowable temperature (TS)
psi	Unit of measurement for pressure, pound-force per square inch, 1 psi = 6894.75 Pa. All pressure values [bar/psi] refer to positive pressure [bar _g /psi _g], unless specifically stated otherwise.
psi _g	Unit of measurement for pressure relative to atmospheric pressure
PV	Solenoid valve
Ra in µm	Average roughness value, describes the roughness of a technical surface
RM	Feedback

Abbreviation	Explanation
SES	GEA Tuchenhagen control head for Ex areas, control top system of GEA Tuchenhagen
SET-UP	Self-learning installation, the SET-UP procedure carries out all necessary settings for generating messages during commissioning and maintenance.
SIP	Sterilization in Place, refers to a process for cleaning technical process systems
SMS	Svensk Mjök Standard, Scandinavian pipe dimension
SW	Indicates the size of a tool spanner, "Schlüsselweite"
T.VIS®	GEA Tuchenhagen valve information system, control top system from GEA Tuchenhagen
TS	Maximum permitted operating temperature
T-smart	Valve series from GEA Tuchenhagen
UL	Underwriters Laboratories, a certification organization established in the USA
UV	Ultraviolet, ultraviolet radiation is a wavelength of light
V	Volt, unit of measurement for voltage
VARICOMP®	Pipe expansion compensator from GEA Tuchenhagen
VMQ	High-polymer vinyl methyl polysiloxane, silicone rubber, MVQ = synonym
W	Watt, unit of measurement for power
Y	Control air connection for the working cylinder, designation from pneumatic systems
μ	Micro, one millionth of a unit
Ω	Ohm, the unit of electrical resistance named after Georg Simon Ohm

Typical application and description

You can receive two-dimensional and/or three-dimensional drawing files of our components for making your piping planning. For this purpose, please send us your specific request, stating the particular order code and the required drawing format. The required files will then be individually prepared for you.

Available drawing formats:

	Format	Name
2D formats	drw	Native Pro/E
	igs (2D)	IGS file
	dxg	AutoCAD drawing exchange
	pdf (2D)	Adobe Acrobat document
	tif	TIFF (plot)
3D formats	asm	Native Pro/E
	igs (3D)	IGS file
	pdf (3D)	Adobe Acrobat document
	stp	STP file
	bmp (3D)	Bitmap image
	jpg (3D)	JPEG image
	tif (3D)	TIFF image
	sat	Standard ACIS

Any contract placed with us (hereinafter referred to as “the Seller”) by any private-law corporation, company or other business or any public-law legal person or other entity (hereinafter referred to as “the Buyer”) shall exclusively be subject to these Standard Sales Terms and these Standard Sales Terms shall be applicable to any transaction agreed between the Seller and the Buyer thereafter even if no express reference to these Standard Sales Terms is made in connection with any such further transaction. The Seller hereby expressly refuses to accept any standard terms of the Buyer referred to in any correspondence or other document placing any such order. Notwithstanding any reference of the Buyer to any standard terms of the Buyer, the Buyer shall, upon the acceptance of any delivery by the Seller to the Buyer, be deemed to have accepted these Standard Sales Terms. No standard terms of the Buyer shall be applicable to any contract or order placed by the Buyer with the Seller unless such terms have been accepted expressly by the Seller in writing and the performance of any such contract or order by the Seller shall not be deemed to be an acceptance of any terms of the Buyer by the Seller.

Unless otherwise provided for in these Standard Sales Terms, the relationship between the Seller and the Buyer shall be governed by the provisions of applicable law.

If these Standard Sales Terms are otherwise inapplicable or ineffective for any reason whatsoever, the sale of any goods delivered by the Seller to the Buyer (“the Goods”) shall be subject to the reservations of Clause 6 in Article V hereinbelow.

I. General Terms

1. Any bid or offer submitted by the Seller to the Buyer shall not be binding upon the Seller and unless otherwise expressly agreed upon by the Seller and the Buyer, no contract placed by the Buyer shall be effective unless expressly accepted by the Seller in writing.
2. The title to any sample, drawing or other document or information, whether reduced to writing or in electronic form, including but not limited to any copyrights or other rights associated therewith, which may be provided by the Seller to the Buyer shall remain vested in the Seller and no such sample, drawing or other document or information may be made accessible by the Buyer to any third party.
3. Any performance or other data or description of any Goods by the Seller in any brochure, price list, bid, proposal, offer or any other document which may form part of any such bid, proposal or offer shall be deemed to be approximate in accordance with standard industry practices and shall not be binding upon the Seller unless expressly accepted as binding by the Seller and the Seller does not make any warranties whatsoever with respect to any properties of any of the Goods.
4. Commercial terms agreed between the Seller and the Buyer shall be interpreted in accordance with Incoterms 2000.

II. Price and Payment

1. Unless expressly otherwise agreed upon, any price agreed between the Seller and the Buyer shall be exclusive of any packaging. Each such price shall be exclusive of any sales tax which shall be billed by the Seller in addition to said price at the rate which may be applicable at any time and from time to time.
2. Unless otherwise agreed upon, the price of any of the Goods shall be paid without any deduction for any reason whatsoever as follows:
 - One third upon the receipt of the Seller’s acceptance of the contract placed by the Buyer
 - One third upon the receipt by the Buyer of the Seller’s notice that all main components of the Goods are ready for shipment
 - The remaining sum upon the transfer of the risks of the Goods to the Buyer and upon the issuance of the Seller’s final invoice for the Goods
3. The Buyer shall not have the right to retain any payment due to the Seller for any reason whatsoever and shall not deduct from any moneys due to the Seller any money owed or allegedly owed by the Seller to the Buyer unless any such counterclaim is undisputed by the Seller or has been awarded to the Buyer by a judgment from which no appeal can be taken.
4. If, during the period between the date on which any contract was awarded by the Buyer to or any order was placed by the Buyer with the Seller and the date on which production for the performance of said contract or order commences, any labor, material and/or production costs associated with said contract or order increase for any reason for which the Seller is not liable and the cost of any of the Goods (as defined in Section 255 of the German Commercial Code) as determined in accordance with generally accepted German accounting principles is shown by the Seller to have risen by more than twenty percent (20 %) since the date of contract award or order placement, then the Seller shall have the right to redetermine the price of any such Goods payable by the Buyer under said contract or order provided however that the Seller shall not be entitled to increase said price by more than the increase in said cost.
5. The Buyer shall pay any amount owing to the Seller within seven (7) calendar days from the due date for the payment of said amount.

III. Delivery Time and Late Delivery

1. The time available to the Seller for the delivery of the Goods (“Delivery Time”) shall be as agreed between the Parties in the contract placed. The Seller shall not be obligated to deliver within said Delivery Time unless all technical and commercial details have been agreed upon order placement and the Buyer performs all of its obligations under said contract or order such as, without limitation, any obligation to obtain necessary certificates, approvals or permits from agencies or authorities and the obligation to make any advance payment provided that

any non-satisfaction of any of the preceding conditions shall operate to increase the Delivery Time reasonably and further provided that no delay for which the Seller may be liable shall operate to increase the Delivery Time.

2. The Seller shall not be obligated to deliver any Goods within the Delivery Time unless the Seller receives deliveries from its suppliers as and when ordered by the Seller provided that the Seller shall notify the Buyer as soon as reasonably possible of any delay in delivery it may become aware of.
3. The Seller shall be deemed to have delivered within the Delivery Time if the Goods have left the Seller's works prior to the expiry of the Delivery Time or the Seller has notified the Buyer prior to the expiry of the Delivery Time that the Goods are ready for Delivery.
4. If the Buyer fails to make any payment to the Seller under any contract or order whatsoever when said payment is due, the Seller shall, upon notice to the Buyer, have the right to discontinue performance under the contract awarded or the order placed for the Goods until the payment the Buyer has failed to make when due has been received provided however that the Seller shall not have said right if the payment so due but not made is immaterial.
5. If the Seller is unable to deliver any Goods within the Delivery Time for reasons of force majeure, due to any labor dispute or due to any circumstances beyond the reasonable control of the Seller then the Delivery Time shall be extended reasonably. The Seller shall notify the Buyer of the commencement and the end of any such circumstances as soon as may be reasonably possible.

IV. Transfer of Risk and Acceptance

1. Unless expressly otherwise agreed upon between the Seller and the Buyer, the Goods shall be delivered ex works.
2. If the Goods to be delivered by Seller to the Buyer are divisible, then the Seller shall have the right to deliver and to invoice to the Buyer said Goods in reasonable parts and the Buyer shall not have the right to retain payment for any such reasonable part on the grounds of the non-delivery of any other parts of the Goods.
3. If any delivery by the Seller to the Buyer requires acceptance by the Buyer under any express provision of the order placed by the Buyer or at law, then any delivery by the Seller to the Buyer shall be deemed to have been accepted by the Buyer if and in as far as
 - any Goods manufactured or processed by the Seller are, after delivery, sold to or allowed to be used by any third party or
 - any Goods manufactured or processed by the Seller are, after delivery, processed or mixed or combined with any other things with the agreement of the Buyer or

- any Goods manufactured or processed by the Seller are, beyond trials or tests, used by the Buyer or by any third party with the agreement of the Buyer or
- the Goods are accepted by any purchaser from the Buyer.

Whatever may be earlier provided that any prior acceptance under the contract awarded or the order placed by the Buyer or at law shall take precedence over any acceptance under this Clause.

V. Retention of Title

1. The title to all Goods delivered by the Seller to the Buyer shall remain vested in the Seller until the full payment of all accounts receivable by the Seller from the Buyer for any reason whatsoever provided that under current account arrangements the title so retained shall be deemed to be security for any balance owed to the Seller.

The Buyer shall not dispose of any of the Goods the title to which is so vested in the Seller ("Title Reservation Goods") other than in the Buyer's ordinary course of business provided that the Buyer shall no longer have the right so to dispose of any Title Reservation Goods if and as soon as the Buyer fails to make payments when payments are due. The Buyer shall not have the right to pledge or to transfer by way of security the title to any Title Reservation Goods. The Buyer shall be obligated to maintain the rights of the Seller if the Title Reservation Goods are sold by the Buyer to any third party under credit arrangements. The Buyer shall promptly notify the Seller of any lien of attachment, execution or garnishment or any seizure or the like relating to any Title Reservation Goods.

The Buyer hereby assigns to the Seller and the Seller hereby accepts the Buyer's assignment of any title to payment for any of the Goods resold by the Buyer to any purchaser and any security received by the Buyer from any such purchaser for any such payment provided however that the Buyer shall, subject to any notice to the contrary given by the Seller, have the right to collect any such payment and to enforce any such security at its cost. Upon the request of the Seller, the Buyer shall notify the Seller of the debtors against which titles to payment so assigned are held, the securities provided therefor, the type and the amount of the debt of each such debtor and the type and the amount of each such security and deliver to the Seller all documents which may be necessary to collect any amount so owed by any such debtor. Upon notice to the Buyer, the Seller shall have the right to notify any such debtor of the assignment of the title to payment by the Buyer to the Seller hereunder.

2. If the Goods are sold by the Buyer to any purchaser together with any other goods the title to which is not vested in the Seller, then a share of the full title to payment of the Buyer under said sale to said purchaser equal to the price of said Goods agreed between the Buyer and the Seller shall be deemed to have been assigned by the Buyer to the Seller.

3. Upon the request of the Buyer, the Seller shall waive any title to Goods delivered by the Seller to the Buyer in as far as the value of all Goods the title to which has been retained by the Seller hereunder exceeds one hundred ten percent (110 %) of the value of all titles to payment the Seller holds against the Buyer.
4. The Buyer shall, as of the transfer of risks associated with Title Reservation Goods, insure all Title Reservation Goods against any damage or loss or destruction as a result of any fire, inundation, flooding or theft or any destruction or loss or damage in transit provided that the Buyer shall notify the Seller promptly of any such destruction or loss or damage and shall, upon the request of the Seller, provide to the Seller any documentation of any such loss or damage such as, without limitation, any expert report on said destruction or loss or damage, the names of the insurers of said Goods and, as requested by the Seller, the insurance policy or policies relating to the Title Reservation Goods or insurance certificates issued by the insurer or the insurers for the Title Reservation Goods. The Buyer hereby assigns to the Seller, conditionally as of the time of any such destruction or loss of or damage to any Goods, any title against any insurer or any party liable for any such destruction or loss or damage to a maximum amount equal to the price agreed for any such Goods affected by any such destruction or loss or damage by way of security for all moneys owed by the Buyer to the Seller.
5. Any processing of any Title Reservation Goods by the Buyer shall be for the Seller and the Seller shall be deemed to be the processor for the purposes of Section 950 of the German Civil Code. If Title Reservation Goods are processed, combined or mixed with other goods the title to which is not vested in the Seller, then a fraction of the title to the new product equal to the ratio between the price invoiced to the Buyer for the Goods so processed, combined or mixed and the sum of the price invoiced to the Buyer for the Goods so processed, combined or mixed and the price or prices invoiced to the Buyer for the other goods so processed, combined or mixed shall be vested in the Seller. The Buyer shall be the custodian of any such new product the title to which is vested in the Seller in total or in part for the Seller. If any such Title Reservation Goods are processed, combined or mixed with goods of the Buyer and the goods of the Buyer are the main constituents of the new product thereby created, then the Buyer shall be deemed to have transferred to the Seller a fraction of the title to any such new product computed in accordance with the principles of the preceding sentence and shall be the custodian of said new product for the Seller.

The provisions of Clauses 1 through 4 hereinabove applicable to Title Reservation Goods shall apply mutatis mutandis to any new product obtained by processing, combination or mixing in which the Seller acquires in total or in part a title through the operation of this Clause.
6. If these Standard Sales Terms have not been agreed effectively, any transfer of title to any of the Goods shall be subject to the Seller receiving the full price agreed between the Seller and the Buyer therefor.

VI. Defects

1. General
 - 1.1 If Section 377 or Sections 377 and 381 of the German Commercial Code (sales and contract manufacture agreements between business organizations as defined in Section 1 et seq, of the German Commercial Code) are applicable to the order placed, the Buyer shall notify the Seller promptly of any patent defect in any of the Goods provided that said notice shall be given no later than on the fourth (4th) working day following the delivery of said Goods. Any latent defect in any of said Goods shall be notified promptly by the Buyer to the Seller provided that said notice shall be given no later than on the fourth (4th) working day following the discovery of said defect. Each such notice of any defect in any of the Goods shall be in writing. The conditions applicable to any such notice and the effects of a late notice of any defect in any of the Goods shall furthermore be governed by the conditions of law (Sections 377, respectively 377 and 381 of the German Commercial Code).
 - 1.2 If the Buyer is not a business organization, notice of any patent defect in any of the Goods delivered by the Seller to the Buyer shall be given by the Buyer to the Seller within two (2) weeks following the delivery of said Goods in the case of sales and contract manufacture agreements and within two (2) weeks following acceptance in the case of service agreements. The term provided for hereinbefore shall be deemed to have been complied with if said notice is forwarded by the Buyer within said term and received by the Seller within four (4) weeks from such delivery or acceptance as the case may be. The Buyer shall not be entitled to any remedy for any patent defect in any of the Goods if the Buyer fails to give notice as aforesaid unless and in as far as
 - the Seller is liable for said defect due to willful act, neglect or omission, any act of bad faith or any gross negligence,
 - said defect is covered by a warranty of the Seller in accordance with Section 443 of the German Civil Code or
 - said defect is claimed in connection with loss of human life, injury, impairment of health or loss of freedom.
 Provided that any liability of the Seller for any such defect shall be excluded in accordance with the provisions of law such as but not limited to the provisions of Section 640, paragraph 2, or Section 442 of the German Civil Code if the Buyer had known said defect or did not know said defect due to its own gross negligence.
2. Product Defects
 - 2.1 If any of the Goods delivered by the Seller to the Buyer is defective, the Seller shall remedy said defect by repair or replacement. If said remedial action fails, then, subject to the provisions on damages in Article VII hereinbelow, the Buyer shall be entitled to any of the remedies provided for by law.

- 2.2 If any remedial action is taken by the Seller, then the Seller shall bear all costs and expenses occasioned by the removal of said defect such as, without limitation, any transportation or traveling expenses or any labor or material costs provided however that any extra costs occasioned by the Buyer moving the Goods after delivery to a place other than the registered premises of the Buyer shall be carried by the Buyer unless the removal of said Goods is a use for which the Goods are intended.
- 2.3 The Buyer shall give the Seller the time and the opportunity which may be needed to remove any defect in any of the Goods provided that the Seller shall not be held liable for any consequences of not being given such time and opportunity.
- 2.4 Any repair or replacement by the Seller with respect to any Goods shall irrespective of the scope of any such repair or replacement not be deemed to be an acceptance of any liability for any defect in any of the Goods claimed by the Buyer provided that no persons other than legal representatives or procurators under Sect. 49 German Commercial Code ("Prokuristen") of the Seller shall have the right to accept any liability for any defect on behalf of the Seller.
- 2.5 If any defect in any of the Goods claimed by the Buyer shows not to be a defect for which the Seller is liable, then the Buyer shall reimburse to the Seller all costs reasonably incurred by the Seller to remove said alleged defect in good faith provided that material and labor costs so incurred by the Seller shall be reimbursed at the Seller's standard rates applicable at the time when the alleged defect was so removed.
- 2.6 The Buyer shall not be entitled to the removal by the Seller of any defect due to any of the following:
- Improper use of any Goods or use of any Goods for a purpose for which the Goods are not fit or defective installation or commissioning of the Goods by the Buyer or any third party
 - Natural wear and tear, improper or negligent handling, improper maintenance or use of any unfit consumables or utilities
 - Defective construction work, unsuitable foundations or chemical, electrochemical or electrical interference unless caused by the Seller
- 2.7 The Seller shall not be held liable for the consequences of any improper or inappropriate removal of any defect in any of the Goods by the Buyer or any third party or any modification to any of the Goods made without the Seller's prior consent.

3. Legal Defects

- 3.1 The liability of the Seller for the Goods not to be in breach of any third-party industrial property rights or copyrights shall be limited to the Federal Republic of Germany and the country in which the Buyer is registered. The Seller shall have no such liability for any other country, such as any country to which the Goods may be moved by the Buyer, unless such other country has been notified by the Buyer to the Seller prior to awarding the contract or placing the order for the Goods.

- 3.2 If the use of the Goods delivered by the Seller to the Buyer is in breach of any third-party industrial property rights or copyrights and the Seller is liable for said breach according to Clause 3.1 hereinabove, the Seller shall, at its cost, obtain for the Buyer the right to continue the use of said Goods or modify said Goods in a manner reasonably acceptable to the Buyer so that said Goods will no longer be in breach of any such industrial property rights or copyrights. If such rights cannot be obtained at reasonable commercial terms or within a reasonable period of time and if the Goods cannot be so modified, then the Buyer shall have the right, at its discretion, to rescind the contract awarded by the Buyer to the Seller or the order placed by the Buyer with the Seller or to obtain from the Seller a reasonable reduction in the price of said Goods.

The Seller shall in any such event further indemnify the Buyer against any undisputed claims or any claims determined by non-appealable court decision of the owners of such industrial property rights or copyrights.

- 3.3 Subject to Clause 3.4 hereinbelow, the Buyer shall not have the rights under Clause 3.2 hereinabove, unless
- the Buyer notifies the Seller promptly of any breach of industrial property rights or copyrights claimed by any third party,
 - the Buyer reasonably supports the defense of any such claims by the Seller and allows the Seller to make modifications as referred to in Clause 3.2 hereinabove,
 - the Buyer allows the Seller to defend at its own cost any such claim or to make any out-of-court settlement with respect to any such claim as the Seller may think fit,
 - the legal defect is not due to any instructions given by the Buyer to the Seller and
 - the legal defect is not due to any modification of the Goods by the Buyer or any use of the Goods not in conformity with the intended use.
- 3.4 Notwithstanding the limitations in Clauses 3.2 and 3.3 hereinabove, the provisions laid down by law shall apply, if and in as far as
- the title of the Buyer against the Seller is held under Section 478 or under Sections 651 and 478 of the German Civil Code,
 - the Seller is liable for the breach of the industrial property rights or the copyrights due to any willful act, neglect or omission or any gross negligence on the part of the Seller,
 - the Seller warranted (as provided for in Section 443 of the German Civil Code) that the Goods will not violate any industrial property rights or copyrights or
 - any damages claimed as a result of any breach of any industrial property rights or copyrights are on the grounds of any loss of life, injury, loss of health or loss of freedom.

4. Warranties Under Section 443 of the German Civil Code

No person other than a legal representative or a procurator under Sect. 49 German Commercial Code ("Prokuristen") of the Seller will have the right to agree any warranties according to Section 443 of the German Civil Code.

VII. Liability and Damages

1. The Seller shall be liable for any willful acts, neglects and omissions and any gross negligence of its legal representatives and/or any other persons authorized by the Seller to perform any of the obligations of the Seller under any contract awarded to the Seller or order placed with the Seller ("Agent or Employee").
2. In the event of any ordinary negligence of any legal representative, Agent or Employee of the Seller, the liability of the Seller shall be limited to liability for any loss or damage the Seller foresaw when the contract was awarded or the order was placed by the Buyer or should have foreseen when the contract was awarded or the order was placed by the Buyer considering the circumstances the Seller knew or should have known when the contract was awarded or the order was placed by the Buyer.

If and in as far as any loss or damage suffered by the Buyer due to the ordinary negligence of any legal representative, Agent or Employee of the Seller is compensated by any final payment by any insurer under any insurance contract against loss or indemnity concluded by the Buyer or for the Buyer such as, but not limited to any liability, all-risks, transportation, fire or business interruption insurance, the liability of the Seller shall be limited to any losses incurred by the Buyer as a result of any such insurance claim such as, without limitation, any increase in insurance premium. Any liability of the Seller for any loss or damage caused by the ordinary negligence of any of the legal representatives, Agents or Employees of the Seller and covered by a final insurance payment to the Buyer shall be excluded.

Subject to the limitations provided for hereinbefore, any liability of the Seller for any loss or damage caused by the ordinary negligence of any legal representative, Agent or Employee of the Seller shall for each incident be limited to an amount of two hundred fifty thousand Euros (250,000 €).

3. The exclusions and limitations of liability provided for hereinabove shall not apply,
 - if and in as far as the Seller is held liable for any human loss of life, injury or loss of health,
 - if and in as far as the Seller is held liable under the German Product Liability Act or
 - if and in as far as the Seller is held liable under any warranty in accordance with Section 443 of the German Civil Code agreed by the Seller to provide security to the Buyer with respect to the loss or damage incurred by the Buyer.
4. The provisions of Clauses 1 through 3 hereinabove shall not operate to alter any of the provisions of law regarding the onus probandi.

VIII. Limitation

1. The period of limitation with respect to any defect shall be a period of one (1) year provided that said period shall be five (5) years for any defect in any Goods serving as civil engineering structure or structures or any defect in any civil engineering structure caused by any Goods ordinarily used in civil engineering structures.
2. The period of limitation with respect to any other cause under the contract awarded or the order placed by the Buyer or any other cause outside said contract or order shall be a period of eighteen (18) months.
3. Notwithstanding the provisions of Clauses 1 and 2 herein-above, the periods of limitation allowed by law shall apply, if and in as far as
 - the title held by the Buyer against the Seller is under Section 478 or Sections 651 and 478 of the German Civil Code,
 - the title of the Buyer is held on the grounds of any willful act, neglect or omission, any act of bad faith or any gross negligence on the part of any of the legal representatives, Agents or Employees of the Seller,
 - the title held by the Buyer against the Seller is on the grounds of any loss of life, injury, loss of health or loss of freedom of any person,
 - the title held by the Buyer against the Seller is under the German Product Liability Act,
 - the title held is on the grounds of a third party title in rem which grants any such third party a title to the surrender of the Goods (Sect. 438 para.1 subsubpara. a German Civil Code) or
 - the title held is on the grounds of any title recorded in any register of deeds (Sect. 438 para.1 subpara. b German Civil Code).

The provisions in Clauses 1 and 2 shall further not apply if the title is held by the Buyer under a warranty of the Seller in accordance with Section 443 of the German Civil Code provided that any such title shall exclusively be subject to the provisions of Clause 4 hereinbelow.

4. The period of limitation applicable to any warranty of the Seller in accordance with Section 443 of the German Civil Code shall commence upon the delivery of the Goods to the Buyer or, if acceptance by the Buyer is required by law, upon the acceptance of the Goods by the Buyer provided that, in the event of bad faith, said period shall commence as provided for in Section 438, paragraph 3, of the German Civil Code. Said period shall terminate as provided for in Section 438 of the German Civil Code unless a shorter period has been agreed according to the terms of the warranty under Section 443 of the German Civil Code.
5. Clauses 1 through 4 hereinabove shall not operate to alter any of the provisions of Sections 196, 197 and 479 of the German Civil Code or any of the provisions of law applicable to the onus probandi.

IX. Software Use

If the contract awarded by the Buyer to the Seller or the order placed by the Buyer with the Seller provides for the supply of software, the Buyer will be granted a non-exclusive right to use said software and any documentation of said software. Said software will be supplied by the Seller to the Buyer for use with the Goods delivered by the Seller to the Buyer provided that the Buyer shall not have the right to use said software on more than one system.

Any copying, modification or translation of said software or any conversion of the object code of said software into source code shall be limited as provided for in Section 69 et seq. of the German Copyright Act. The Buyer agrees not to remove from said software any reference to the developer of said software such as, without limitation, any copyright reference and not to modify any such reference unless the prior express content of the Seller has been obtained.

Any other rights associated with such software and any documentation of said software and any copies thereof shall remain vested in the Seller or the supplier of said software as the case may be. The Buyer shall not grant any sub-license.

X. Applicable Law and Jurisdiction

1. The relationship between the Seller and the Buyer shall exclusively be governed by the law of the Federal Republic of Germany as the same may be applicable to the relationship between two German parties provided however that the application of the United Nations Convention on Contracts for the International Sale of Goods of 11 April 1980 shall be excluded.
2. If the Buyer is a business or any public-law legal person or other entity, any dispute between the Seller and the Buyer shall be settled by the courts having jurisdiction at the registered offices of the Seller provided however that the Seller shall have the right to bring action against the Buyer in the courts having jurisdiction at the registered offices of the Buyer.
3. If any of the terms and conditions of the Contract or these Standard Sales Terms is or become ineffective, the remaining provisions of the Contract and these Standard Sales Terms shall remain in full force and effect. Any such ineffective provision shall be deemed to have been replaced by the Seller and the Buyer by an effective provision which shall have commercial, financial and economic implications which shall be as close to those of said ineffective provision as may be reasonably.

GEA Tuchenhagen

Contact Data of the Business Unit GEA Flow Components

GEA Tuchenhagen

Headquarters of the Business Unit GEA Flow Components

Am Industriepark 2–10, 21514 Büchen, Germany
Phone +49 4155 49 0, Fax +49 4155 49 2423
geatuchenhagen@gea.com

GEA Aseptomag

Industrie Neuhof 28, 3422 Kirchberg, Switzerland
Phone +41 34 426 29 22, Fax +41 34 426 29 28
info.aseptomag@gea.com

GEA Breconcherry

Unit 4 Porthouse Business Centre, Tenbury Road
Bromyard, Herefordshire, HR7 4FL, UK
Phone +44 1531 632476, Fax +44 1531 633839
cip@gea.com, cip.enquiries@gea.com

GEA Tuchenhagen France

29, route de la Wantzenau, 67800 Hoenheim, France
Phone +33 3 88 19 70 90, Fax +33 3 88 19 70 99
tuchenhagen.france@gea.com

GEA Tuchenhagen North America

33 McAllister Farm Road, Portland, ME 04103, USA
Phone +1 207 797 9500, Fax +1 207 878 7914
gea-fc.us@gea.com

GEA Tuchenhagen Canada

20 King Street West, Unit B
Stoney Creek, ON L8G 1G8, Canada
Phone +1 905 930 8738, Fax +1 905 930 8848
gea-fc.us@gea.com



GEA Tuchenhagen Polska

Ul. BoWiD 9R, 75-209 Koszalin, Poland
Phone +48 94 346 75 40 do 43, Fax +48 94 340 58 35
service.pl@gea.com

GEA Tuchenhagen China

248 Guanghua Road, Shanghai 201108, P.R. China
Phone +86 21 3126 6008, Fax +86 21 3126 0680
tuchenhagen.cn@gea.com

GEA Flow Components India

#3A1, Bommasandra Industrial Area
Hebbagodi Hosur Road
Bengaluru, 560099, India (Karnataka)
Phone +91 -80 4968 2300
tuchenhagen.india@gea.com

Detailed information on our entire product portfolio is available at www.gea.com.



We live our values.

Excellence • Passion • Integrity • Reliability • GEA-versity

GEA Group is a global engineering company with multi-billion euro sales, and operations in more than 50 countries. Founded in 1881, the company is one of the largest providers of innovative equipment and process technology. GEA Group is listed in the STOXX® Europe 600 Index.

GEA Tuchenhagen GmbH

Am Industriepark 2 – 10, 21514 Büchen, Germany

Phone: +49 4155 49-0

sales.geatuchenhagen@gea.com, www.gea.com